

Keysight U5855A True*R* Thermal Imager



User's Guide

NOTICE: This document contains references to Agilent Technologies. Agilent's former Test and Measurement business has become Keysight Technologies. For more information, go to www.keysight.com.



Notices

© Keysight Technologies 2014

No part of this manual may be reproduced in any form or by any means (including electronic storage and retrieval or translation into a foreign language) without prior agreement and written consent from Keysight Technologies as governed by United States and international copyright laws.

Manual Part Number

U5855-90000

Edition

Edition 2, August 2014

Keysight Technologies
1400 Fountaingrove Parkway
Santa Rosa, CA 95403

Warranty

The material contained in this document is provided “as is,” and is subject to change, without notice, in future editions. Further, to the maximum extent permitted by the applicable law, Keysight disclaims all warranties, either express or implied, with regard to this manual and any information contained herein, including but not limited to the implied warranties of merchantability and fitness for a particular purpose. Keysight shall not be liable for errors or for incidental or consequential damages in connection with the furnishing, use, or performance of this document or of any information contained herein. Should Keysight and the user have a separate written agreement with warranty terms covering the material in this document that conflict with these terms, the warranty terms in the separate agreement shall control.

Technology Licenses

The hardware and/or software described in this document are furnished under a license and may be used or copied only in accordance with the terms of such license.

Restricted Rights Legend

U.S. Government Restricted Rights. Software and technical data rights granted to the federal government include only those rights customarily provided to end user customers. Keysight provides this customary commercial license in Software and technical data pursuant to FAR 12.211 (Technical Data) and 12.212 (Computer Software) and, for the Department of Defense, DFARS 252.227-7015 (Technical Data - Commercial Items) and DFARS 227.7202-3 (Rights in Commercial Computer Software or Computer Software Documentation).

Safety Notices

CAUTION



A **CAUTION** notice denotes a hazard. It calls attention to an operating procedure, practice, or the likes of that, if not correctly performed or adhered to, could result in damage to the product or loss of important data. Do not proceed beyond a **CAUTION** notice until the indicated conditions are fully understood and met.

WARNING

A **WARNING** notice denotes a hazard. It calls attention to an operating procedure, practice, or the likes of that, if not correctly performed or adhered to, could result in personal injury or death. Do not proceed beyond a **WARNING** notice until the indicated conditions are fully understood and met.

Safety Symbols

The following symbols on the instrument and in the documentation indicate precautions which must be taken to maintain safe operation of the instrument.

	Caution, risk of danger (refer to this manual for specific Warning or Caution information)
	Laser radiation

Safety Considerations

Read the information below before using this instrument.

The following general safety precautions must be observed during all phases of operation, service, and repair of this instrument. Failure to comply with these precautions or with specific warnings elsewhere in this manual violates safety standards for design, manufacture, and intended use of the instrument. Keysight Technologies assumes no liability for the customer's failure to comply with these requirements.

WARNING

- **Do not use the device if it is damaged. Before you use the device, inspect the casing. Look for cracks or missing plastic. Do not operate the device around explosive gas, vapor, or dust.**
- **Always use the device with the cables provided.**
- **Observe all markings on the device before establishing any connection.**
- **Turn off the device before removing the battery cover.**
- **When servicing the device, use only the specified replacement parts.**
- **Do not operate the device with the battery cover or portions of the cover removed or loosened.**
- **Use only the designated AC/DC power adapter or charger provided by the manufacturer to avoid any unexpected hazards.**
- **Use only the battery pack supplied with the device. Do not disassemble/modify the battery pack or leave it under direct heat/sunlight.**
- **Keep the battery pack away from water, fire, or heat.**
- **Avoid any contact with battery leakage to prevent personal injuries. If there is leakage or strange smell, remove the battery pack immediately from the device or the external battery charger.**
- **Do not connect the positive terminal and the negative terminal of the battery pack (metallic part) to each other with any metal objects, such as wires.**
- **Do not continue to charge the battery pack if it does not become charged within the specified charging time.**
- **Do not apply impact to or insert foreign objects into the battery pack.**
- **Do not use the camera on a tripod in an area with large vibration or shock.**
- **Do not use the device under water or with conductive gloves or cloths worn or in a strong electromagnetic field.**
- **Do not stare into the torch light.**

WARNING

Laser pointer precautions:

- This laser pointer is a Class 2 laser product.
- Laser beam contact with the eyes may cause visual impairment.
- Do not point the laser beam towards people.
- Do not stare into the laser beam.
- This measuring device is intended for professional use and is not suitable for general use.

CAUTION

Use of controls or adjustments or performance of procedures other than those specified herein may result in hazardous radiation exposure.



CAUTION

- The device uses a highly-sensitive infrared detector. Ensure to comply with the requirements in “**Environmental Conditions**” on page VII when using the device.
- Do not apply excessive stress to the LCD screen, the focus adjustment ring, or the camera lens to avoid damages.
- Avoid direct rays or shock to the visible or infrared camera lens of the device.
- The following condition may be observed when the device acquires or saves a visible image. This condition is not a device failure.

- The color of the visible image changes periodically or may be different from the real target object when the image is replayed in the freeze mode.

To avoid this condition, perform image acquisitions by changing the camera angle. In this case, it is recommended to acquire visible images by observing the image on the screen.

- The following condition may be observed in outdoor data acquisitions. This condition is not a device failure.
 - If the contrast is great (e.g., due to backlight), the object may appear darker on the camera display as compared to the brightness of the background.
- **Do not input laser beam (CO₂ laser, etc.) to avoid damage to the infrared detector.**

To avoid this condition, control the frame so that it covers only the target object.

- If bright sunlight enters the visible camera, the entire picture may become reddish. To avoid this, shield the camera from bright sunlight.

CAUTION

- If the device is used in a manner not specified by the manufacturer, the device protection may be impaired.
- Always use a dry cloth to clean the device. Do not use ethyl alcohol or any other volatile liquid to clean the device.
- Do not permit any blockage of the ventilation holes of the device.

Environmental Conditions

This instrument is designed for indoor use and in an area with low condensation. The table below shows the general environmental requirements for this instrument.

Environmental condition	Requirement
Temperature	Operating condition • -15 °C to 50 °C Storage condition • -40 °C to 70 °C
Humidity	Operating condition • 50% RH to 95% RH at 40 °C Storage condition • 95% RH at 40 °C
Altitude	Up to 2000 m
Pollution degree	2

Regulatory Information

The U5855A complies with the following safety and Electromagnetic Compatibility (EMC) requirements:





Safety compliance

- Laser safety: IEC 60825-1:2001/EN 60825-1:2001 (Laser Class 2)
- IEC 61010-1:2010/EN 61010-1:2010

EMC compliance

- IEC 61326-1:2005/EN61326-1:2006
- CISPR11:2003/EN55011:2007, Group 1 Class A
- Canada: ICES/NMB-001: Issue 4, June 2006
- Australia/New Zealand: AS/NZS CISPR 11:2004

Regulatory Markings

	<p>The CE marking is a legal compliance marking of the European Community. This CE marking shows that the product complies with all the relevant European Legal Directives.</p>		<p>The C-tick mark is a registered trademark of the Spectrum Management Agency of Australia. This signifies compliance with the Australia EMC Framework regulations under the terms of the Radio Communication Act of 1992.</p>
<p>ICES/NMB-001</p>	<p>ICES/NMB-001 indicates that this ISM device complies with the Canadian ICES-001. Cet appareil ISM est conforme a la norme NMB-001 du Canada.</p>		<p>This instrument complies with the WEEE Directive (2002/96/EC) marking requirement. This affixed product label indicates that you must not discard this electrical or electronic product in domestic household waste.</p>
	<p>This symbol is a South Korean Class A EMC Declaration. This is a Class A instrument suitable for professional use and in electromagnetic environment outside of the home.</p>		<p>This symbol indicates the time period during which no hazardous or toxic substance elements are expected to leak or deteriorate during normal use. Forty years is the expected useful life of the product.</p>

Waste Electrical and Electronic Equipment (WEEE) Directive 2002/96/EC

This instrument complies with the WEEE Directive (2002/96/EC) marking requirement. This affixed product label indicates that you must not discard this electrical or electronic product in domestic household waste.

Product Category:

With reference to the equipment types in the WEEE directive Annex 1, this instrument is classified as a “Monitoring and Control Instrument” product.

The affixed product label is as shown below.



Declaration of Conformity (DoC)

The Declaration of Conformity (DoC) for this instrument is available on the Keysight Web site. You can search the DoC by its product model or description at the Web address below.

<http://regulations.products.keysight.com/DoC/search.htm>

NOTE

If you are unable to search for the respective DoC, contact your local Keysight representative.

Table of Contents

1 Introduction

About This Manual	2
Documentation map	2
Safety notes	2
Preparing the U5855A	3
Check the shipment	3
Install the hand strap	5
Install and charge the battery	6
Insert the SD memory card	7
Turn on the U5855A	8
Set up the U5855A	9
The U5855A in Brief	13
Display screen	17

2 Image Capture, Processing, and Measurement Functions

Camera Controls	20
Capture images	20
Image Saving	23
Preview and save an image	23
Add tags	26
Edit tags	31
Delete tags	32
Save an image directly	33
Edit an image	33
Image Playback	36
Delete multiple images (Thumbnail playback mode)	40
Measurement Controls	42
Set the temperature range	42

Set the center spot	44
Set the max/min tracking	45
Set the moveable spots and boxes	46
Set the delta temperature	50
Turn off all measurements	52
Imaging Controls	53
Set the color palette	53
Set the color alarm	55
Digital Zoom	59
Parameter Controls	61
Set the emissivity (ϵ)	62
Set the reflected temperature (RT)	65
Set the object distance (OD), ambient temperature (AT), and humidity (Hum)	69
Set the transmissivity (τ)	70

3 Data Management and System-Related Functions

Data Management Controls	74
Perform image logging	74
View the SD card memory status	78
Manage image folders	79
Format the SD card	83
System-Related Settings	84
Configure the Quick Start Tutorial	84
Save/recall instrument setups	87
Turn on/off visible image auto-save	88
Configure the display items	89
Configure the main key press functions	91
Set the power saving mode	92
Set the LCD brightness	94
Set the temperature unit ($^{\circ}\text{C}$ or $^{\circ}\text{F}$)	94

Set the date and time	94
Set the video out format	95
Set the language	95
Display the system and owner information	96
Reset the U5855A to factory default settings	98

4 Characteristics and Specifications

Product Characteristics	100
Specifications	102
Performance specifications	102
Laser specifications	104
Supplemental characteristics	105

THIS PAGE HAS BEEN INTENTIONALLY LEFT BLANK.

List of Figures

- Figure 1-1 The front and side panels at a glance 13
- Figure 1-2 The rear panel at a glance 14
- Figure 1-3 The display at a glance 17

THIS PAGE HAS BEEN INTENTIONALLY LEFT BLANK.

List of Tables

Table 1-1	Rear panel descriptions	14
Table 1-2	Display descriptions	17
Table 2-1	Emissivity table	64

THIS PAGE HAS BEEN INTENTIONALLY LEFT BLANK.

**U5855A True/IR Thermal Imager
User's Guide**

1

Introduction

About This Manual 2
Preparing the U5855A 3
The U5855A in Brief 13

This chapter guides you to set up the U5855A for the first time. A summary of all the U5855A features is also given.

About This Manual

The descriptions and instructions in this manual apply to the Keysight U5855A TrueIR Thermal Imager (hereafter referred to as the U5855A or the instrument).

Documentation map

The following manuals and software are available for your instrument.

Check the manual revision on the first page of each manual.

- **User's Guide.** This manual.
- **Quick Start Guide.** Printed copy, included with shipment.
- **Service Guide.** Free download at the Keysight Web site.
- **Keysight TrueIR Analysis and Reporting Tool.** Free download at the Keysight Web site.

Safety notes

Safety notes are used throughout this manual (refer to the “**Safety Notices**” section for format examples). Familiarize yourself with each of the notes and its meaning before operating your instrument.

More pertinent safety notes for using this instrument are located under the “**Safety Considerations**” section.

Do not proceed beyond a safety notice until the indicated conditions are fully understood and met.

Preparing the U5855A

Check the shipment

When you receive your instrument, check the shipment according to the following procedure.

- 1 Inspect the shipping container for damage. Signs of damage may include a dented or torn shipping container or cushioning material that indicates signs of unusual stress or compacting. Save the packaging material in case the instrument needs to be returned.
- 2 Carefully remove the contents from the shipping container, and verify that the standard items are included in the shipment according to the standard shipped items list shown on [page 4](#).
- 3 For any enquiries, refer to the Keysight contact numbers on the back of this manual.

If any item is found missing or damaged, contact your nearest Keysight Sales Office.

Keep the original packaging in case the U5855A has to be returned to Keysight in the future. If you return the U5855A for service, attach a tag identifying the owner and model number. Include also a brief description of the problem.

1 Introduction
Preparing the U5855A

Standard shipped items



KeySight U5855A True/R Thermal Imager



Hard carrying case



Power adapter



Power cord



Li-Ion rechargeable
battery



SD memory card



USB Standard-A to Mini
Type-B interface cable, 1 m



Video RCA to RCA
interface cable, 2 m



KeySight U5855A
Quick Start Guide

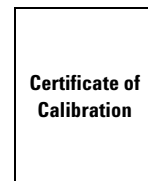

Certificate of
Calibration

Install the hand strap

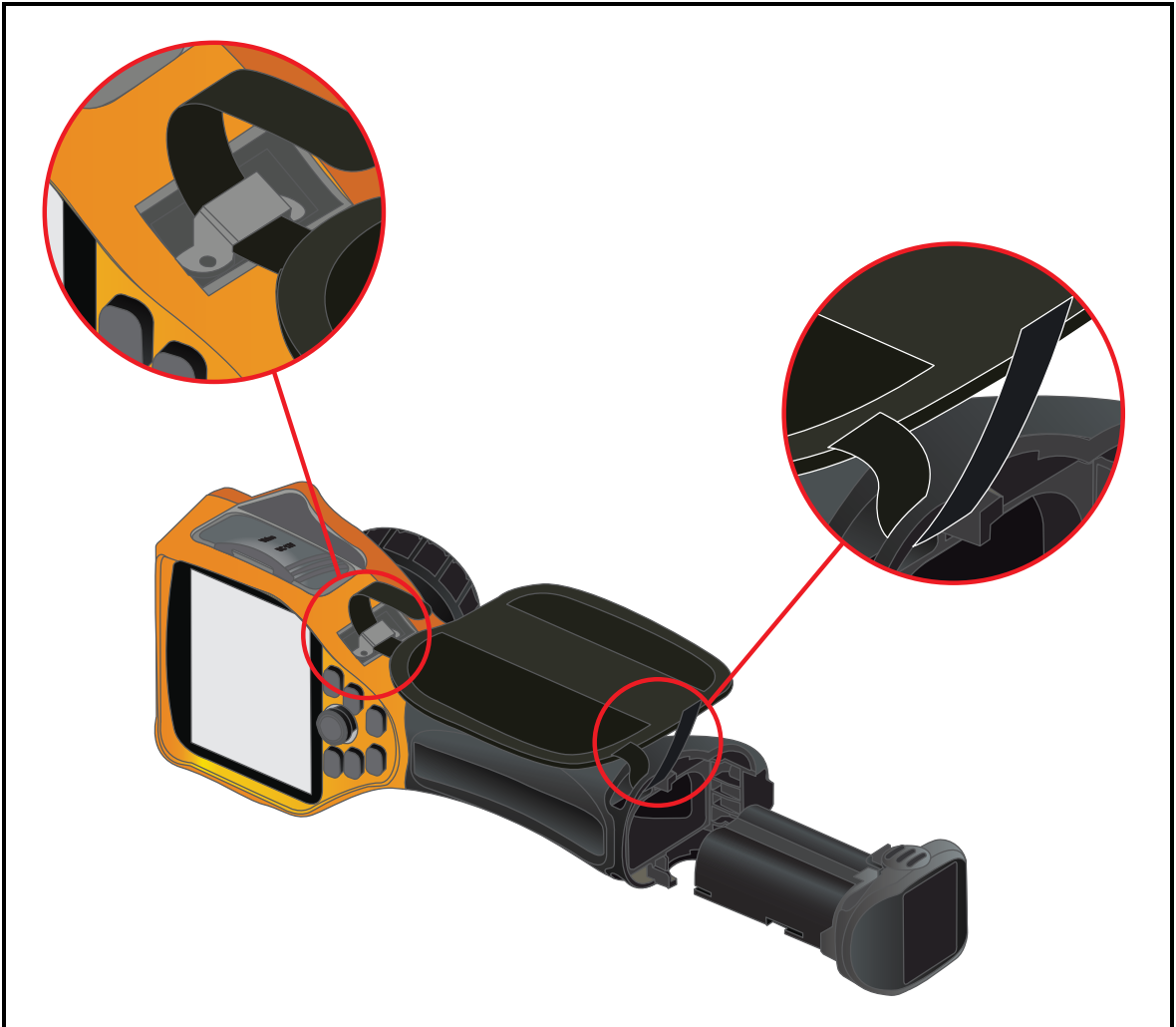

1 Introduction
Preparing the U5855A

Install and charge the battery

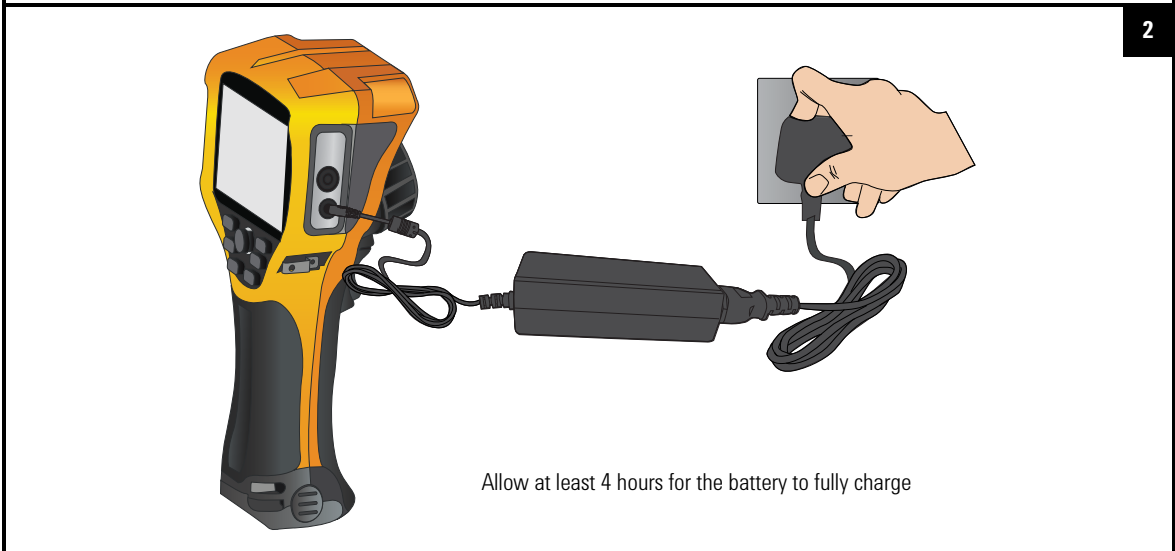
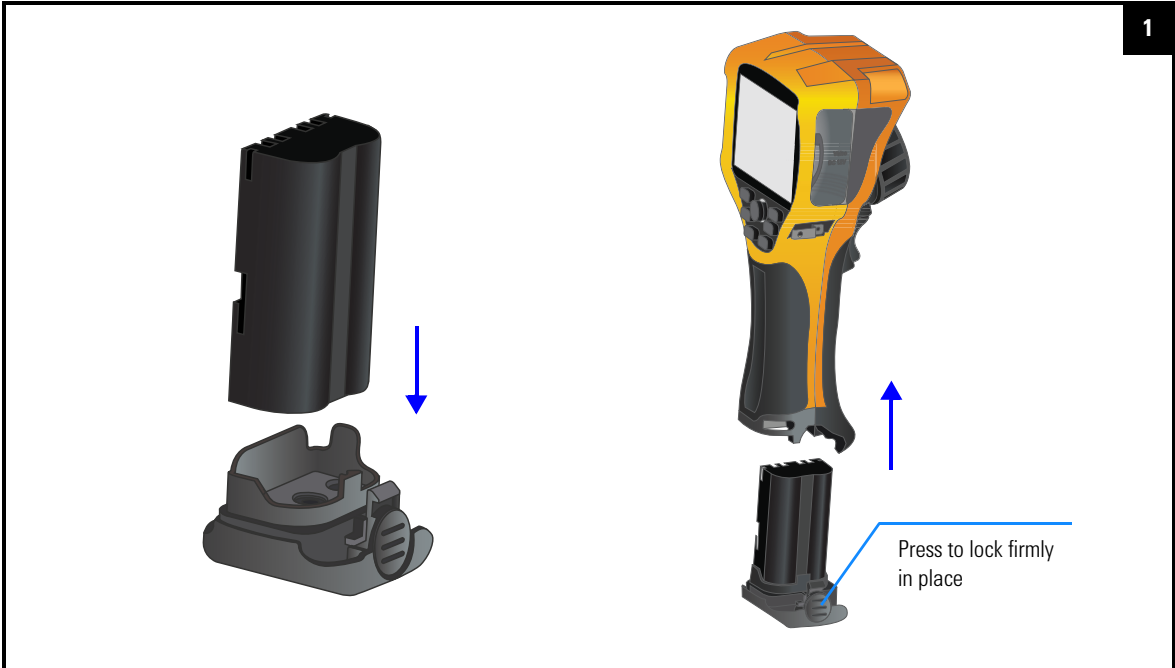

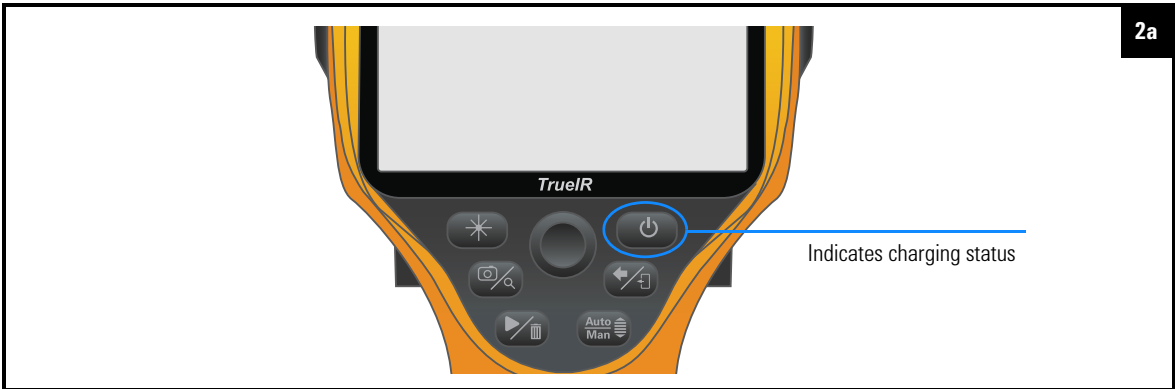

NOTE

Refer to “LED status indication” on page 15 and “Battery status indication^[1]” on page 18 for more details.

Insert the SD memory card







1 Introduction

Preparing the U5855A

Turn on the U5855A

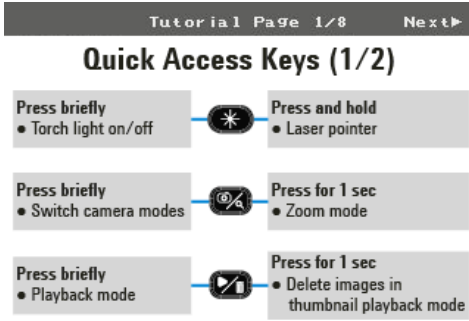
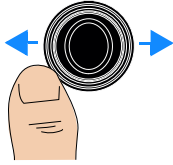
CAUTION

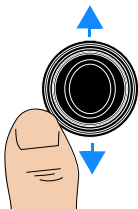
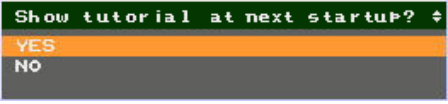
DO NOT REMOVE the battery or the SD memory card before power is turned off and the LED light goes off entirely. Otherwise it may damage the U5855A or destroy files saved in the SD memory card.

<p>1</p>  <p>Press for 2 seconds to turn on/off</p>	<p>2</p> <p>When you turn on the U5855A for the first time or after a factory reset, you will be prompted to perform initial setups. Refer to "Set up the U5855A" on page 9.</p>
<p>3</p> <p>Quick start tutorial:</p> 	<p>4</p> <p>To navigate the tutorial pages:</p>  <p>To exit:</p>  <p>OR</p> 
<p>5</p>  <p>⇒</p>  <p>⇒</p> 	
<p>6</p> <p>Ready to take measurements with specified accuracy after warm-up</p>	

NOTE

- The U5855A automatically turns off if a key is not pressed for 20 minutes (default). Pressing the power key will turn it back on.
- If Auto Sleep is enabled, the U5855A automatically goes to sleep if a key is not pressed for 10 minutes (default). Pressing any key except the power key will turn it back on.

Refer to **“Set the power saving mode” on page 92** for more details.

Set up the U5855A

NOTE

This is only applicable when you turn on the U5855A for the first time, or after restoring the factory settings.

Set the language



1 Introduction

Preparing the U5855A

Set the date, time, and temperature unit

1



Settings	
Date Format	YY/MM/DD
Date	14/02/27
Time	17:15:43
Unit	°C
OK	

Settings: \leftarrow To select
Enter to change/confirm

2



Settings	
Date Format	Y YY/MM/DD
Date	1 14/02/27
Time	1 17:15:43
Unit	°C DD/MM/YY
OK	

Settings: \leftarrow To select
Enter to change/confirm

3

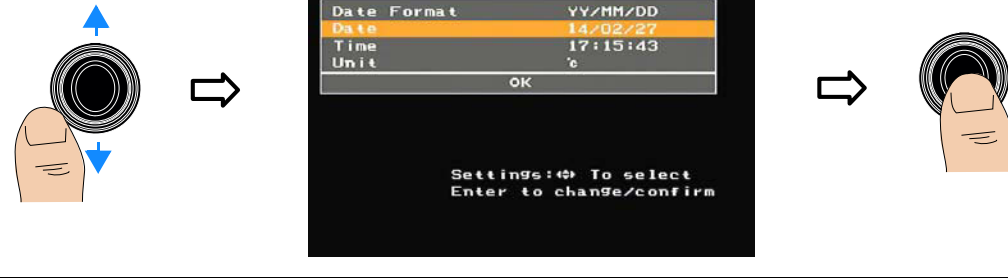

Settings	
Date Format	YY/MM/DD
Date	14/02/27
Time	17:15:43
Unit	°C
OK	

Settings: \leftarrow To select
Enter to change/confirm

• Year: **00 to 99** (00: year 2000) • Month: **01 to 12** • Date: **01 to 31**

4

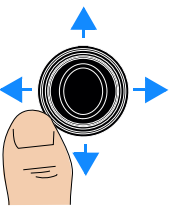

Push left/right to move the indicator.
Push up/down to increase/decrease the digits.

Settings	
Date Format	YY/MM/DD
Date	14/02/27
Time	17:15:43
Unit	°C
OK	

Settings: (left/right) To select
Enter to change/confirm



5

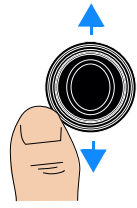

Settings

Settings	
Date Format	YY/MM/DD
Date	14/02/27
Time	17:15:43
Unit	°C
OK	

Settings: (left/right) To select
Enter to change/confirm



• Hour: **00 to 23** • Minute: **00 to 59** • Second: **00 to 59**

6

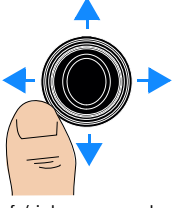

Push left/right to move the indicator.
Push up/down to increase/decrease the digits.

Settings	
Date Format	YY/MM/DD
Date	14/02/27
Time	17:15:43
Unit	°C
OK	

Settings: (left/right) To select
Enter to change/confirm



1 Introduction

Preparing the U5855A

7



Settings

Date Format	YY/MM/DD
Date	14/02/27
Time	17:15:43
Unit	°C

OK

Settings: ⬅ To select
Enter to change/confirm

8



Settings

Date Format	YY/MM/DD
Date	14/02/27
Time	17:15:43
Unit	°C

OK

Settings: ⬅ To select
Enter to change/confirm

9

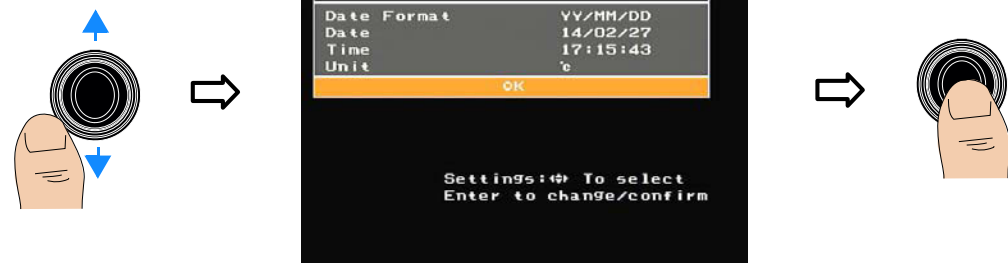

Settings

Date Format	YY/MM/DD
Date	14/02/27
Time	17:15:43
Unit	°C

OK

Settings: ⬅ To select
Enter to change/confirm

The U5855A in Brief



Figure 1-1 The front and side panels at a glance

[1] Press briefly to toggle between the image freeze (capture) or run operation.
Press for 1 second to perform a quick-save.

1 Introduction

The U5855A in Brief

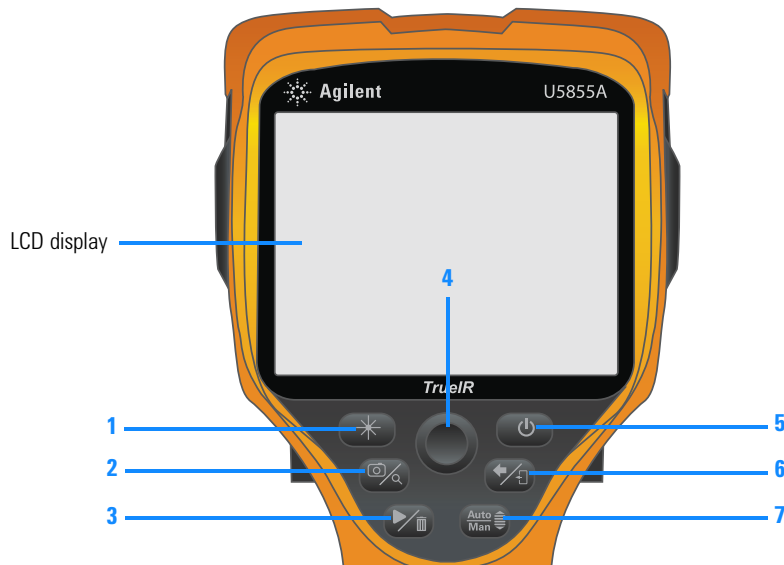

Figure 1-2 The rear panel at a glance

Table 1-1 Rear panel descriptions

Legend	Description
1 Light/Laser control key ^[1]	Press briefly to toggle the torch light on or off. Press and hold to turn on the laser pointer, and release to turn it off.
2 Camera/Zoom key	Press briefly to select the camera mode (refer to “Camera mode switching flow” on page 16 for more details). Press for 1 second to access the zoom mode.
3 Play/Delete key	Press briefly to play back saved images. Press for 1 second for delete operations (in thumbnail playback mode).
4 Navigation/Enter key	Press the center of the key briefly to use as an Enter key or to access the Main Menu. Push the sides of the key for up/down/left/right navigation. The left/right sides can be pushed to open or close sub-menus.
5 Power on/off key (with LED status indicator)	Press for 2 seconds to turn the U5855A on or off.
6 Back/Exit key	Press briefly to return to the previous menu. Press for 1 second to exit any menu.

Table 1-1 Rear panel descriptions (continued)

Legend	Description
7	<p>Press briefly to switch from auto to manual scaling.</p> <ul style="list-style-type: none"> • In the manual scaling mode, press briefly to perform auto scaling once. • Manual scaling allows you to set the temperature level or the temperature span (upper/lower temperature limits) of the temperature scale.
Auto/Manual scale key	<div style="display: flex; justify-content: space-around; align-items: center;"> <div style="text-align: center;"> <p>Adjust temperature level:</p> </div> <div style="text-align: center;"> <p>Adjust temperature span:</p> </div> </div> <p style="text-align: center;">Press for 1 second to switch from manual to auto scaling.</p>

[1] Torch light and laser pointer are not functional when the U5855A is in the power-saving mode.

LED status indication

Unit turned on/off	LED	Status
Off	Red (flashing)	Charging
	Off	Full charge
	Red	Charge error
On	Green	Charging
	Green	Full charge
	Red	Charge error
	Red (flashing)	Laser on
	Green (flashing)	Power saving (Auto-Sleep) mode

1 Introduction
The U5855A in Brief

Camera mode switching flow

**IR image
(with Fine Resolution enabled)**



Visible image



**Picture-in-picture
(fusion) image**

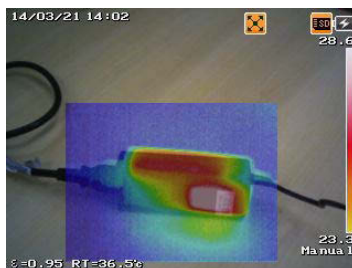

Blend (fusion) image

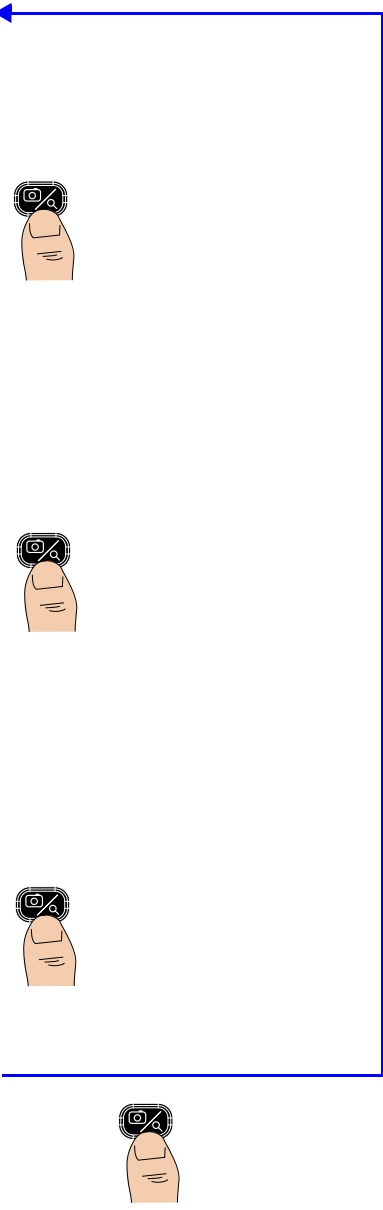

Display screen

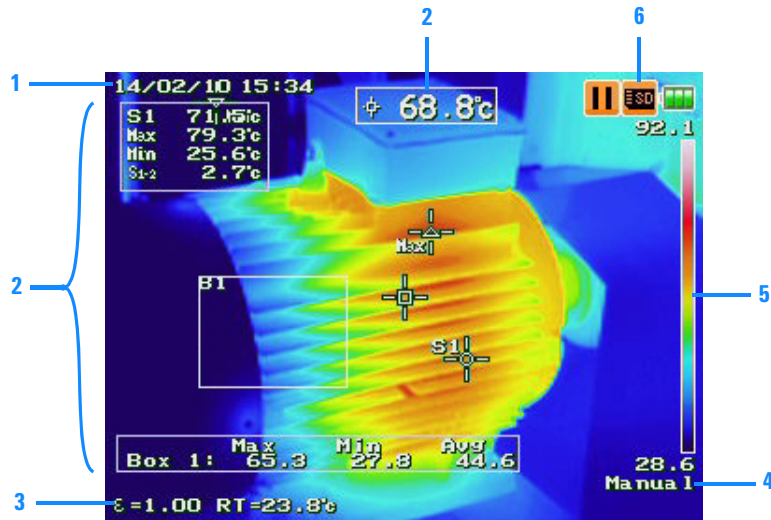













Figure 1-3 The display at a glance





Table 1-2 Display descriptions

Description							
1	Date/time						
2	Measurement results and tools						
3	Info bar (selectable up to four items to display)						
4	Auto/manual scaling						
5	Temperature scale/color bar with upper and lower temperature limits						
6	Icons as status indicators:						
	Freeze mode		Laser on		SD memory card inserted		Edit mode
	Battery status		Fine Resolution mode		Image logging operation		USB connectivity

1 Introduction
The U5855A in Brief

Battery status indication^[1]

Full (~2.5 to 5 hours remaining) 	1 to 2.5 hours remaining 	15 to 60 minutes remaining 	Empty (flashing) 
--	---	---	---

Charging 	Fully charged (with adapter connected) 	No battery (with adapter connected) 	Charge error (flashing) (with adapter connected) 
---	--	---	--

[1] Typical operating time of a new battery.

2 Image Capture, Processing, and Measurement Functions

Camera Controls	20
Image Saving	23
Image Playback	36
Measurement Controls	42
Imaging Controls	53
Digital Zoom	59
Parameter Controls	61

This chapter guides you on how to operate the main functions of the U5855A.

Camera Controls

Capture images

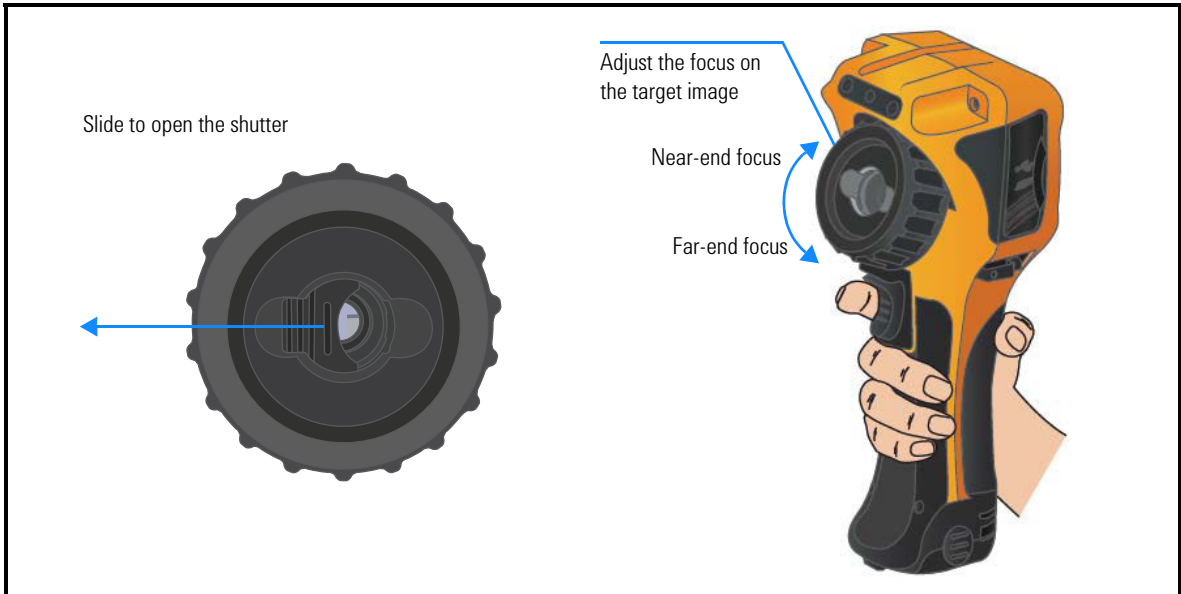

To select a camera mode

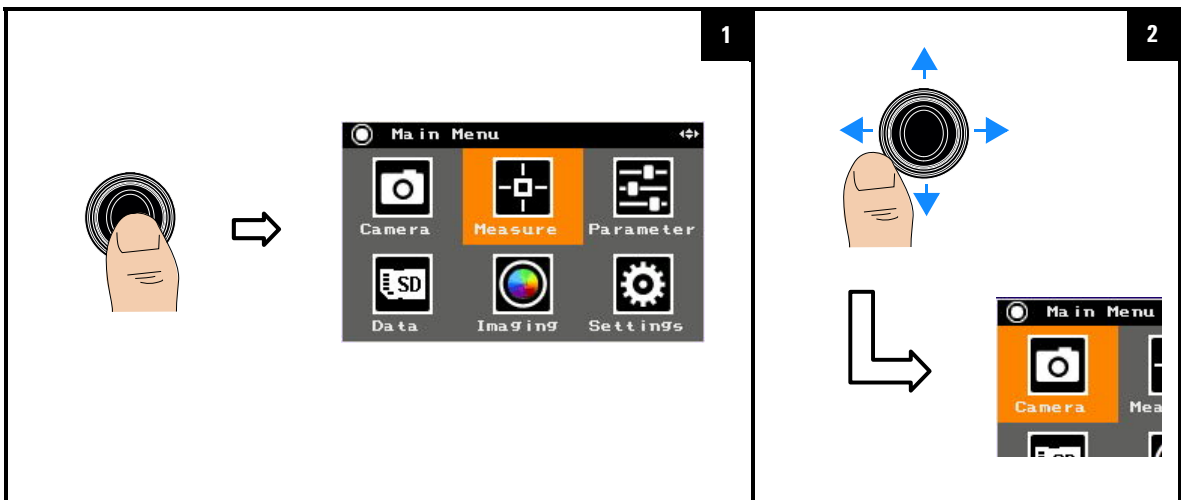



The U5855A provides two fusion camera modes:

- Picture in Picture
- Blend

These modes enable you to identify abnormalities easily with a fusion of both IR and visible images

3

Select a camera mode:

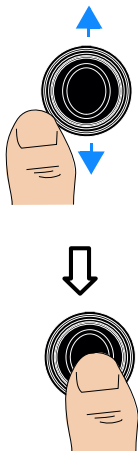

4

To enable/disable fine resolution (FR)

1

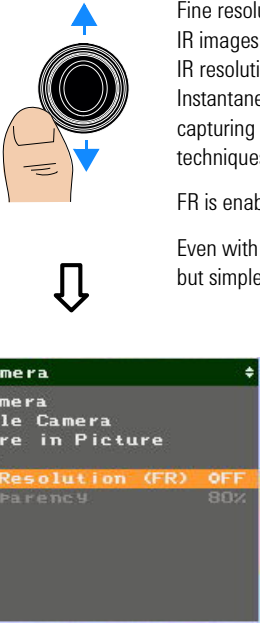

Fine resolution thermal imaging produces high quality IR images by capturing images with 4x more effective IR resolution and approximately 1.5x finer Instantaneous Field of View (IFOV) using multi-frames capturing and sophisticated image processing techniques.

FR is enabled by default.

Even with the FR disabled, the same resolution retains but simpler interpolation techniques are used in place.

2

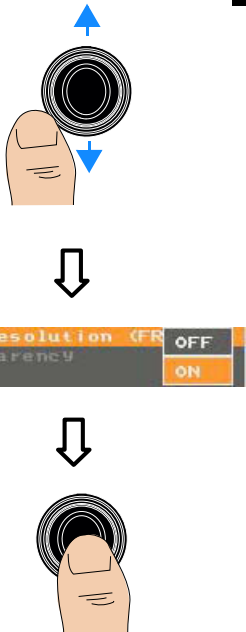

2 Image Capture, Processing, and Measurement Functions

Camera Controls

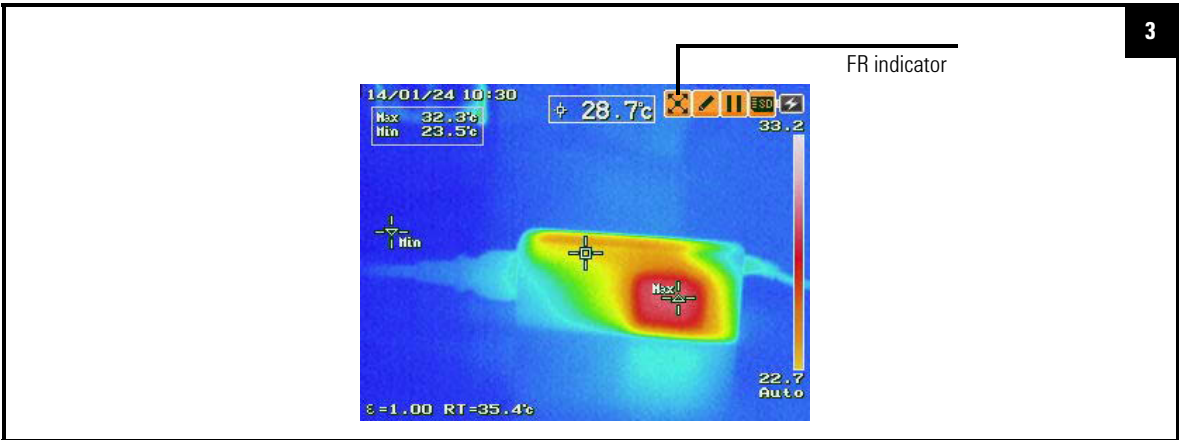

To set the transparency of fusion images

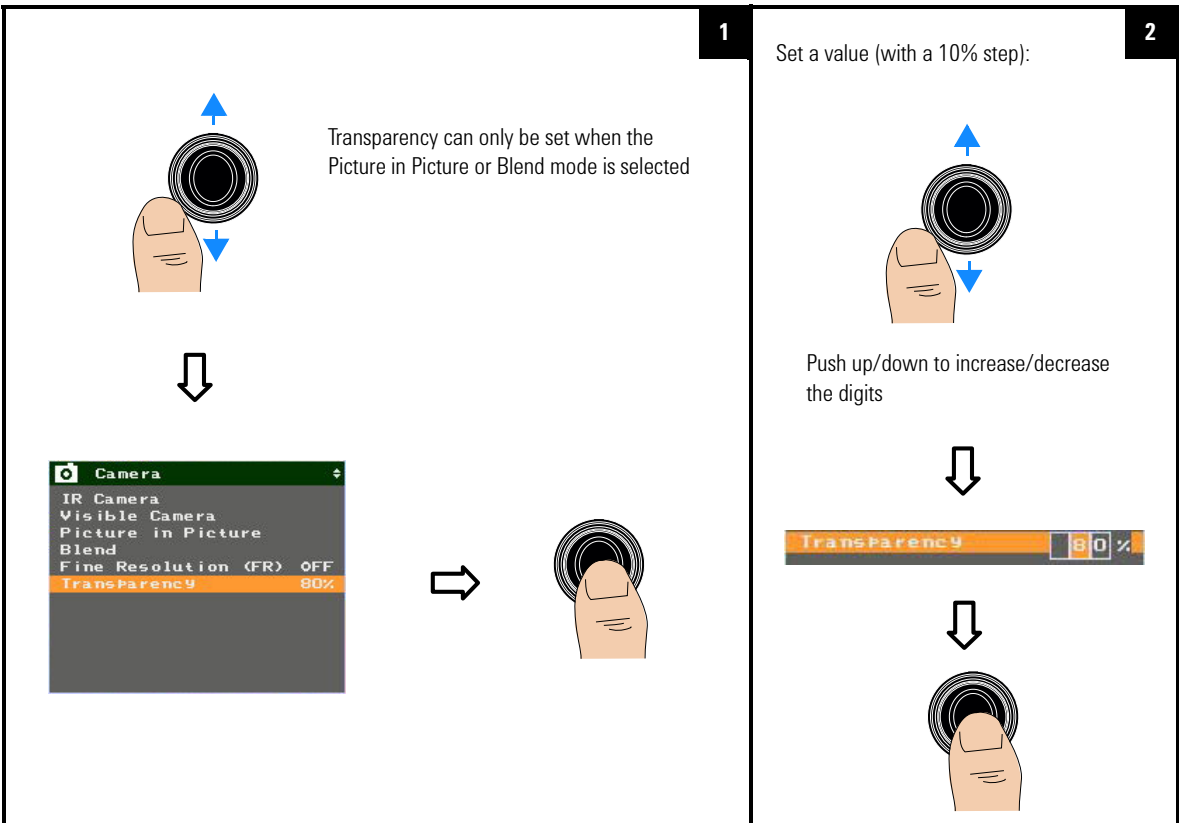
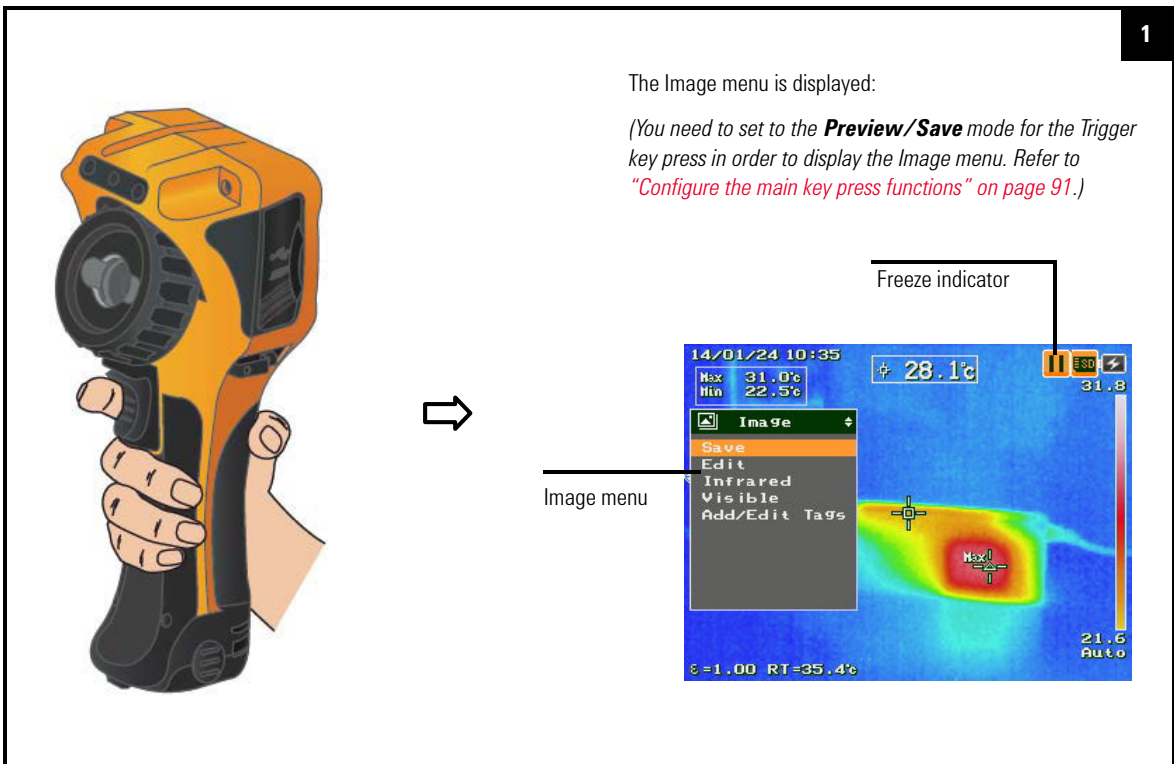

Image Saving

After capturing the images, you can save them into the SD memory card inserted in the U5855A. You can also add tags and edit the images.

Preview and save an image



2 Image Capture, Processing, and Measurement Functions

Image Saving

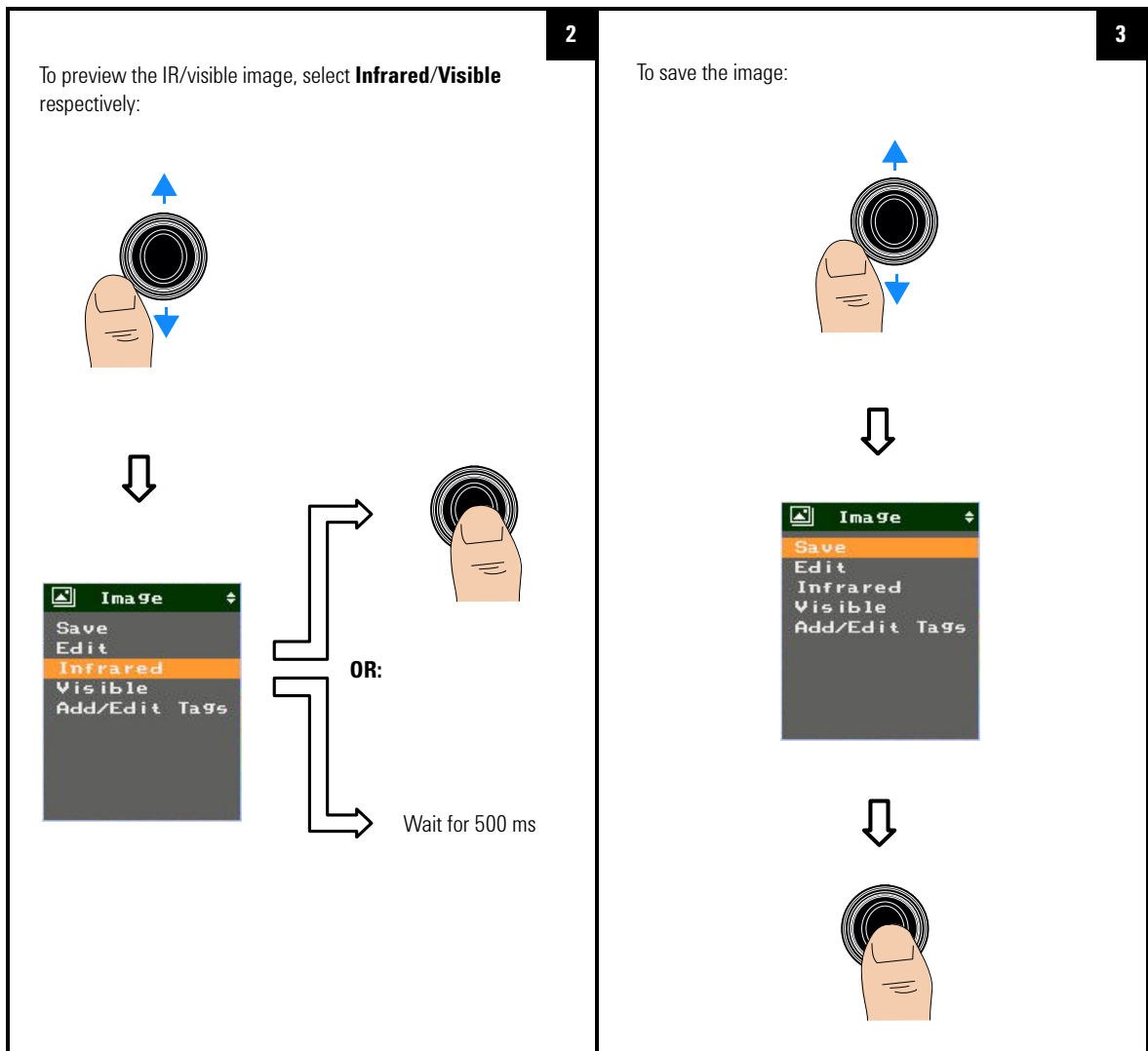

Once the image has been saved, it will return to the run mode

4

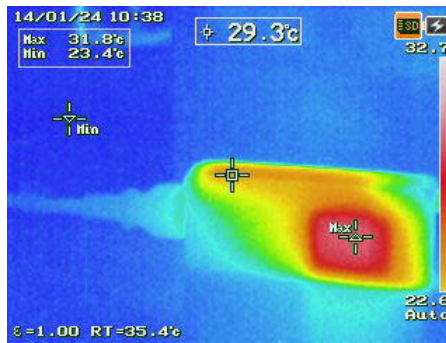

- If the auto save visible image setting is enabled, both the IR and visible images will be saved
- If the auto save visible image setting is disabled, only the IR image will be saved

Refer to ["Turn on/off visible image auto-save"](#) on page 88 for more details

2 Image Capture, Processing, and Measurement Functions

Image Saving

Add tags

You can include photo tags (up to three visible images) and note tag that correspond to your IR image analysis.

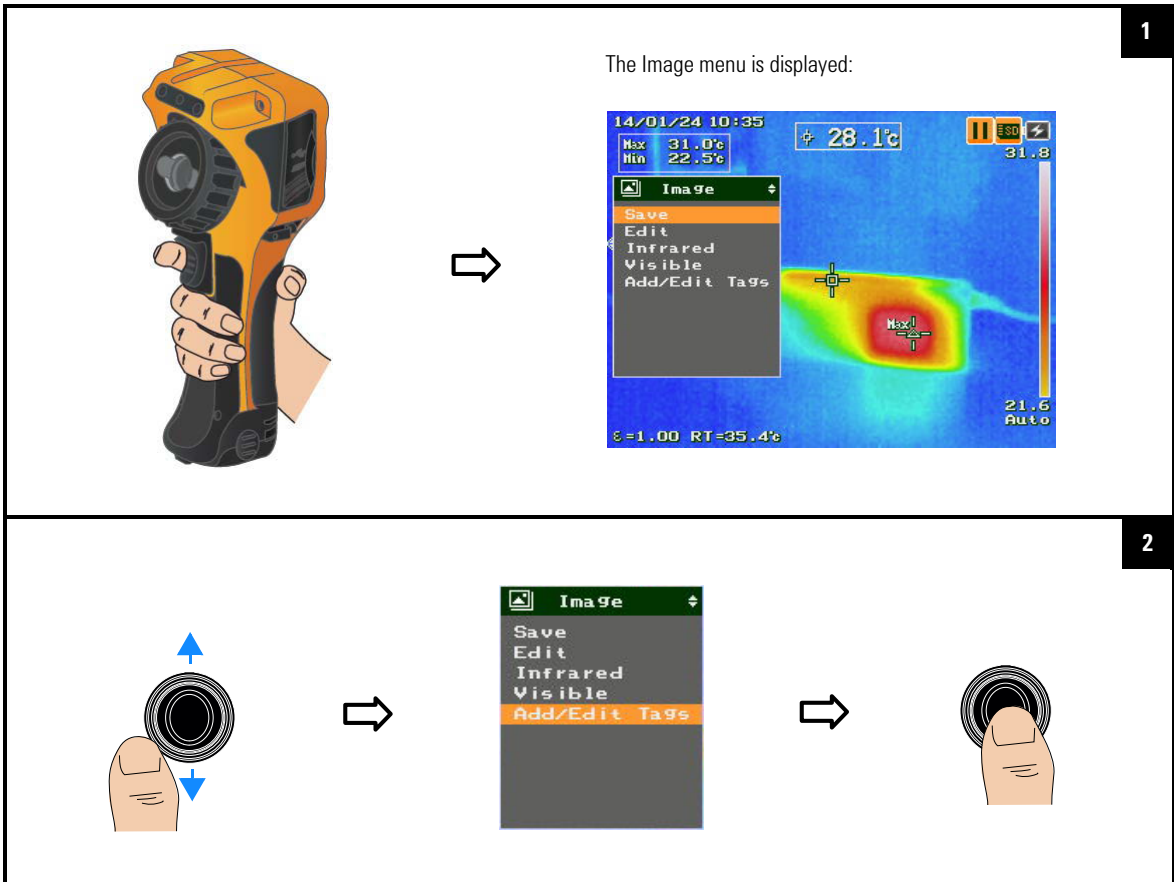

To add photo tags

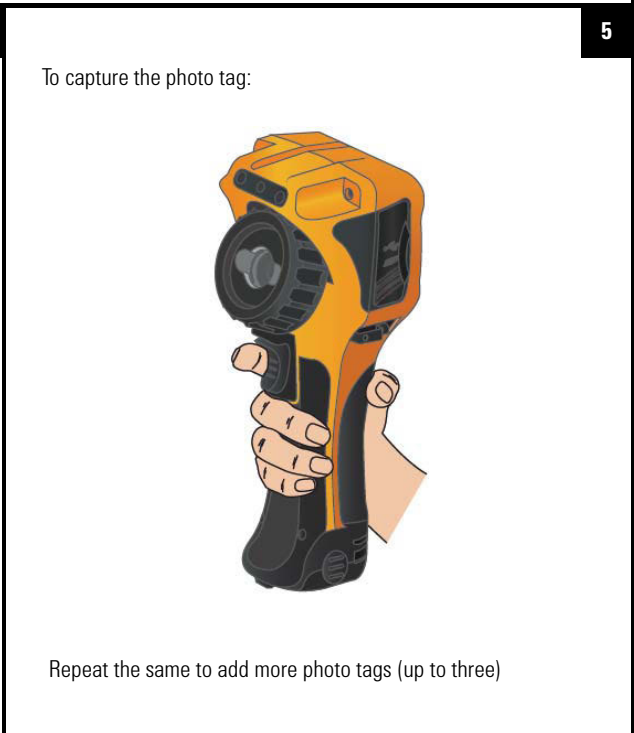
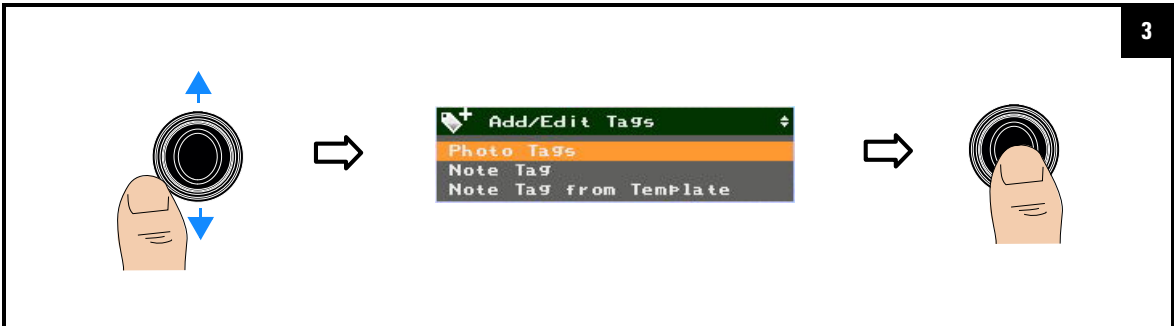

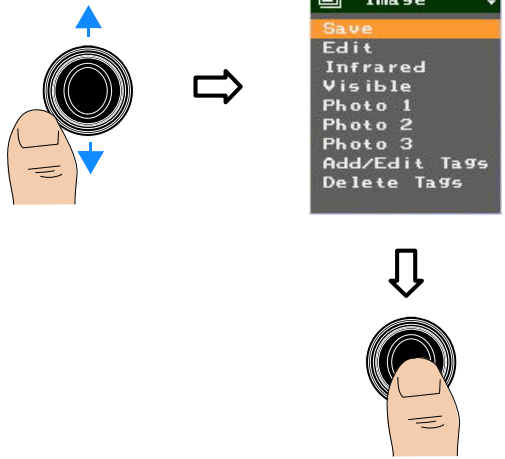

2 Image Capture, Processing, and Measurement Functions

Image Saving

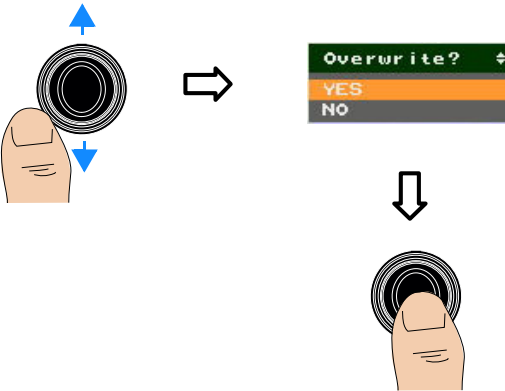
<p>6</p> <p>Photo tag indicators will be added:</p>  <p>The screenshot shows a menu titled 'Image' with options: Save, Edit, Infrared, Visible, Photo 1, Photo 2, Photo 3, Add/Edit Tags, and Delete Tags. The 'Photo 1' option is highlighted with a red box.</p>	<p>7</p> <p>Save the photo tags with the IR and visible images, and return to the run mode:</p>  <p>The diagram illustrates the process: a finger presses a button with blue arrows pointing up and down. A right-pointing arrow leads to a screenshot of the 'Image' menu where 'Save' is highlighted. A down-pointing arrow leads to a finger pressing the button again.</p>
<p>8</p> <p>If there is already an existing photo tag and you want to add a new tag, a message prompts you to overwrite the existing tag:</p>  <p>The screenshot shows a dialog box titled 'Overwrite?' with two options: YES and NO. The 'YES' option is highlighted with an orange bar.</p>	<p>9</p> <p>Select YES to proceed with adding tags or NO to return to the previous screen:</p>  <p>The diagram illustrates the process: a finger presses a button with blue arrows pointing up and down. A right-pointing arrow leads to a screenshot of the 'Overwrite?' dialog box where 'YES' is highlighted. A down-pointing arrow leads to a finger pressing the button again.</p>

To add a note tag

Repeat steps 1 to 2 from "To add photo tags" on page 26

1

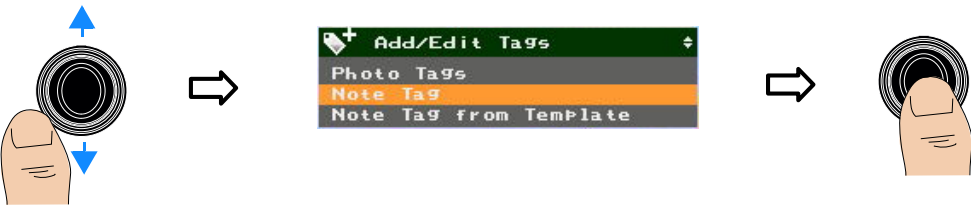

2

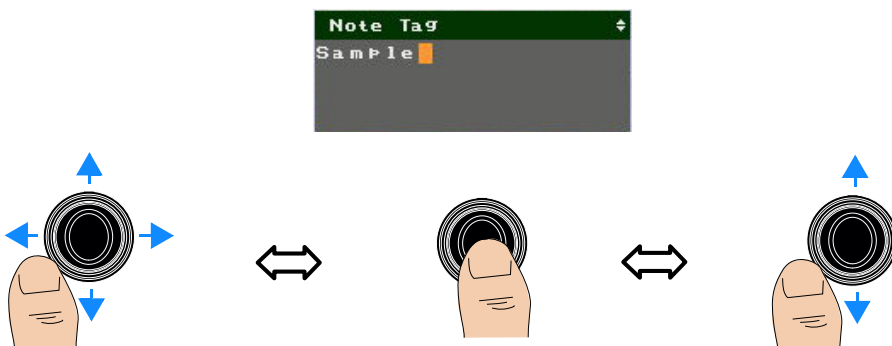

Move the character cursor

Confirm the cursor position

Select and enter the character

If there is no character input, a blank character is inserted

3

Press for 1 second

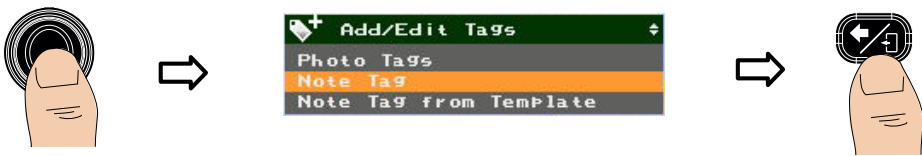

2 Image Capture, Processing, and Measurement Functions

Image Saving

Note tag indicator will be added:

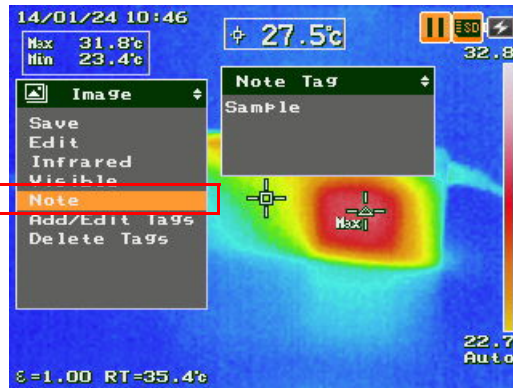

4

Save the note tag with the IR and visible images, and return to the run mode:



5

To preview the note tag:

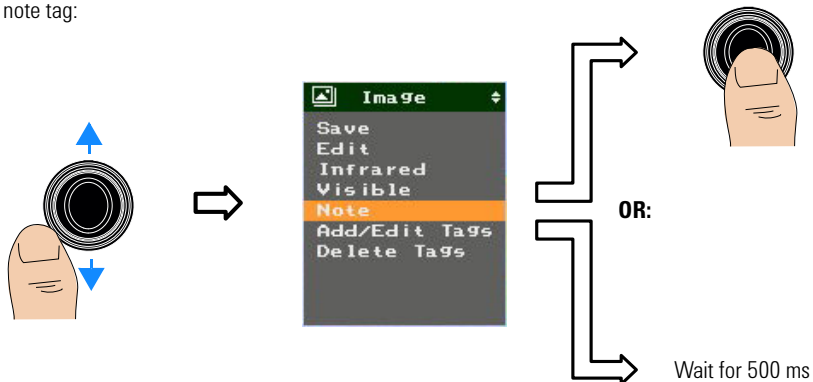

6

To add a note tag from a template file

You can download the note tag template file from the Keysight Web site to the SD memory card.

To ensure proper use of this template file, use the following guidelines:

- File name and extension: NOTE_TMP.TXT
- File format: Text file/Notepad
- File location: Root of the SD card
- Character code: ASCII (20h to 7Fh)
- Maximum line: 50 lines
- Maximum characters per line: 64 characters

Follow steps 1 to 2 from ["To add photo tags"](#) on page 26

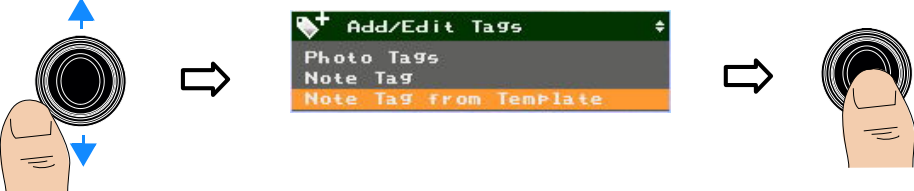

The diagram illustrates the process of adding a note tag from a template file. It shows a hand holding a lens, followed by a menu titled 'Add/Edit Tags' with options 'Photo Tags', 'Note Tag', and 'Note Tag from Template'. The 'Note Tag from Template' option is highlighted. The process then shows a hand holding the lens again.

The note tag template file that you downloaded will be displayed. Select a template and follow the same procedure from ["To add a note tag"](#) on page 29.

Edit tags



The diagram illustrates the process of editing tags. It shows a hand holding a lens, followed by a menu titled 'Image' with options 'Save', 'Edit', 'Infrared', 'Visible', and 'Add/Edit Tags'. The 'Add/Edit Tags' option is highlighted.

Follow the same procedure as adding tags. Existing tags will be overwritten by the edited tags.

2 Image Capture, Processing, and Measurement Functions

Image Saving

Delete tags

1

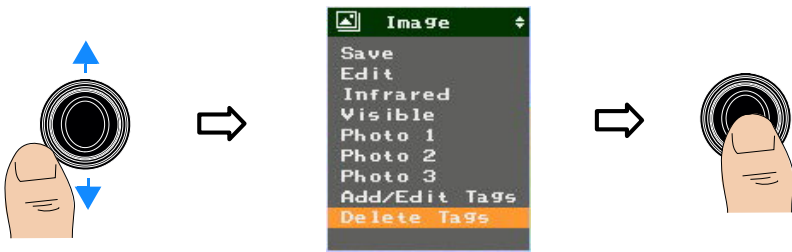

2



Select **YES** to delete all photo tags, note tag, or all photo and note tags. Select **NO** to return to the previous screen.



When a tag is deleted, the respective tag indicator will be removed from the Image menu

Save an image directly

Press for 1 second to save



Edit an image



The Image menu is displayed:

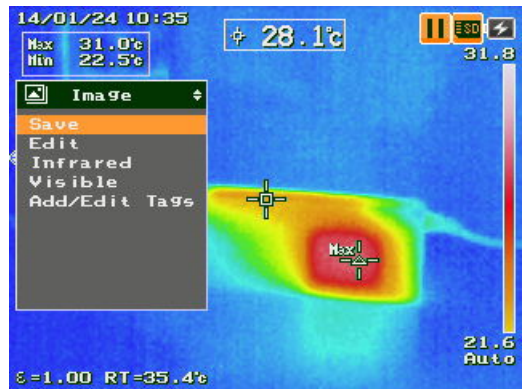

2 Image Capture, Processing, and Measurement Functions

Image Saving

2

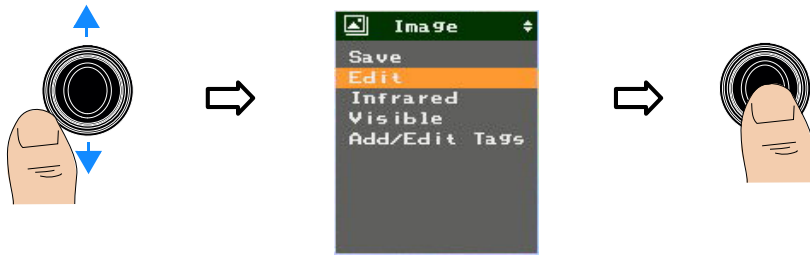

3

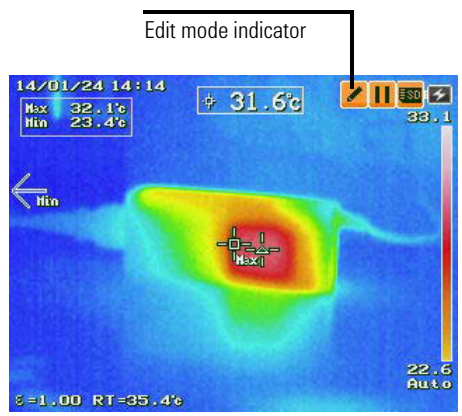

You can then proceed to edit the image or access the Main Menu for more operations

4

To exit the Edit mode:

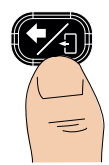

OR



- Select **Save and exit** to overwrite the existing image and save your new edits, and then exit the Edit mode
- Select **Exit without saving** to exit the Edit mode without saving your edits
- Select **CANCEL** to return to the current operation



2 Image Capture, Processing, and Measurement Functions

Image Playback

Image Playback

This feature allows you to play back saved images.

Full screen/Thumbnail playback mode operation summary:

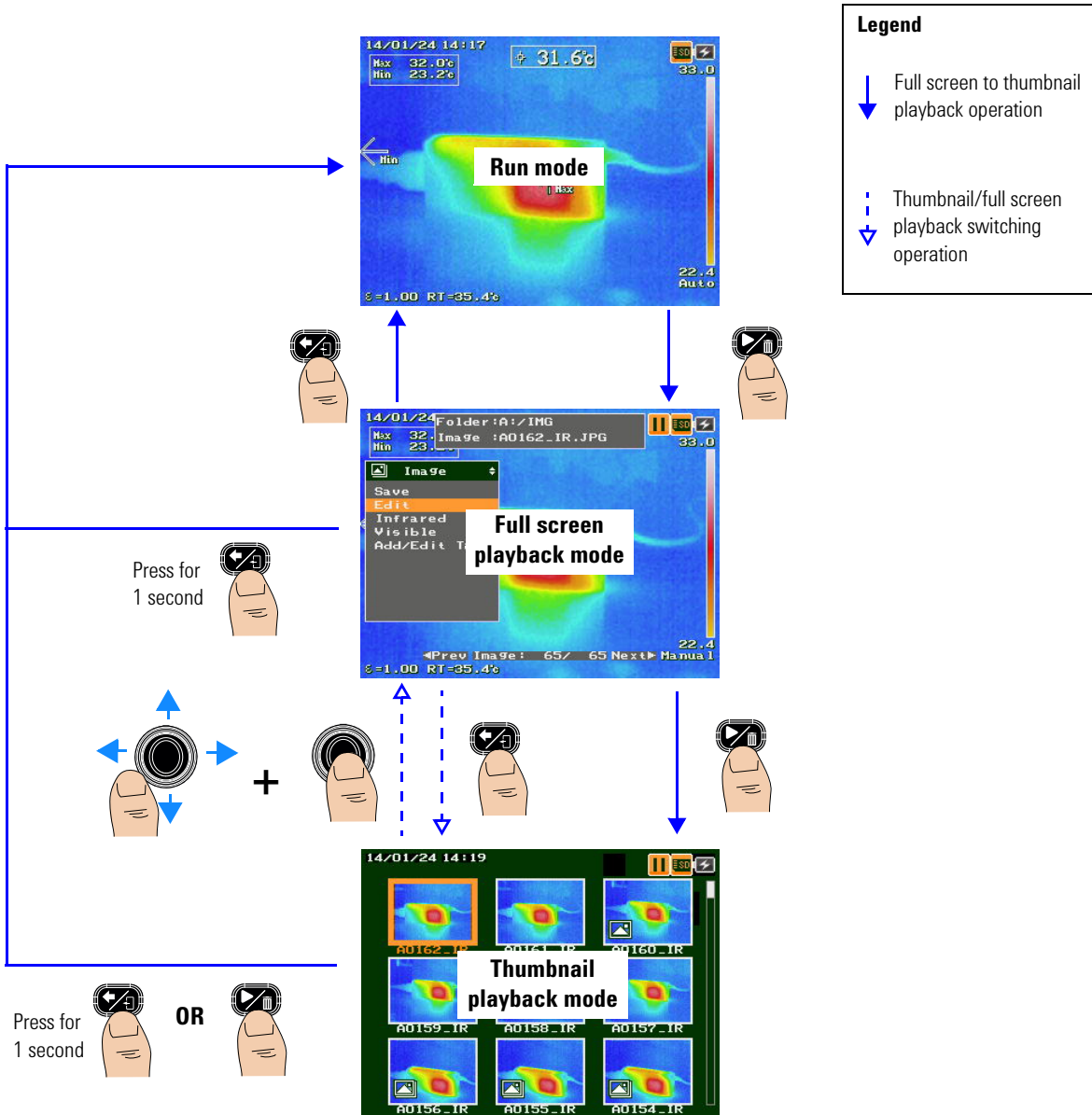

Full screen playback mode overview:

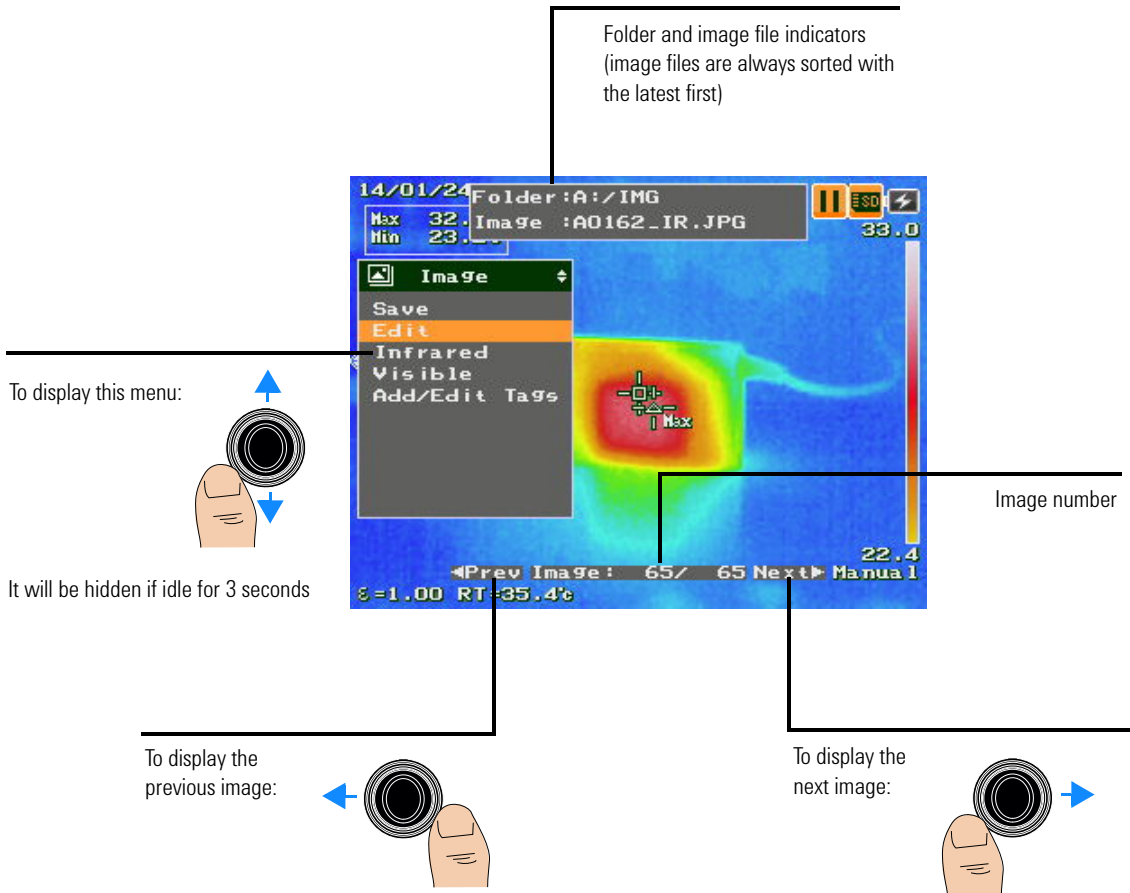

NOTE

In the playback mode, you can perform the same Image menu operations as described in the previous sections of this chapter.

2 Image Capture, Processing, and Measurement Functions Image Playback

Thumbnail playback mode operation summary:

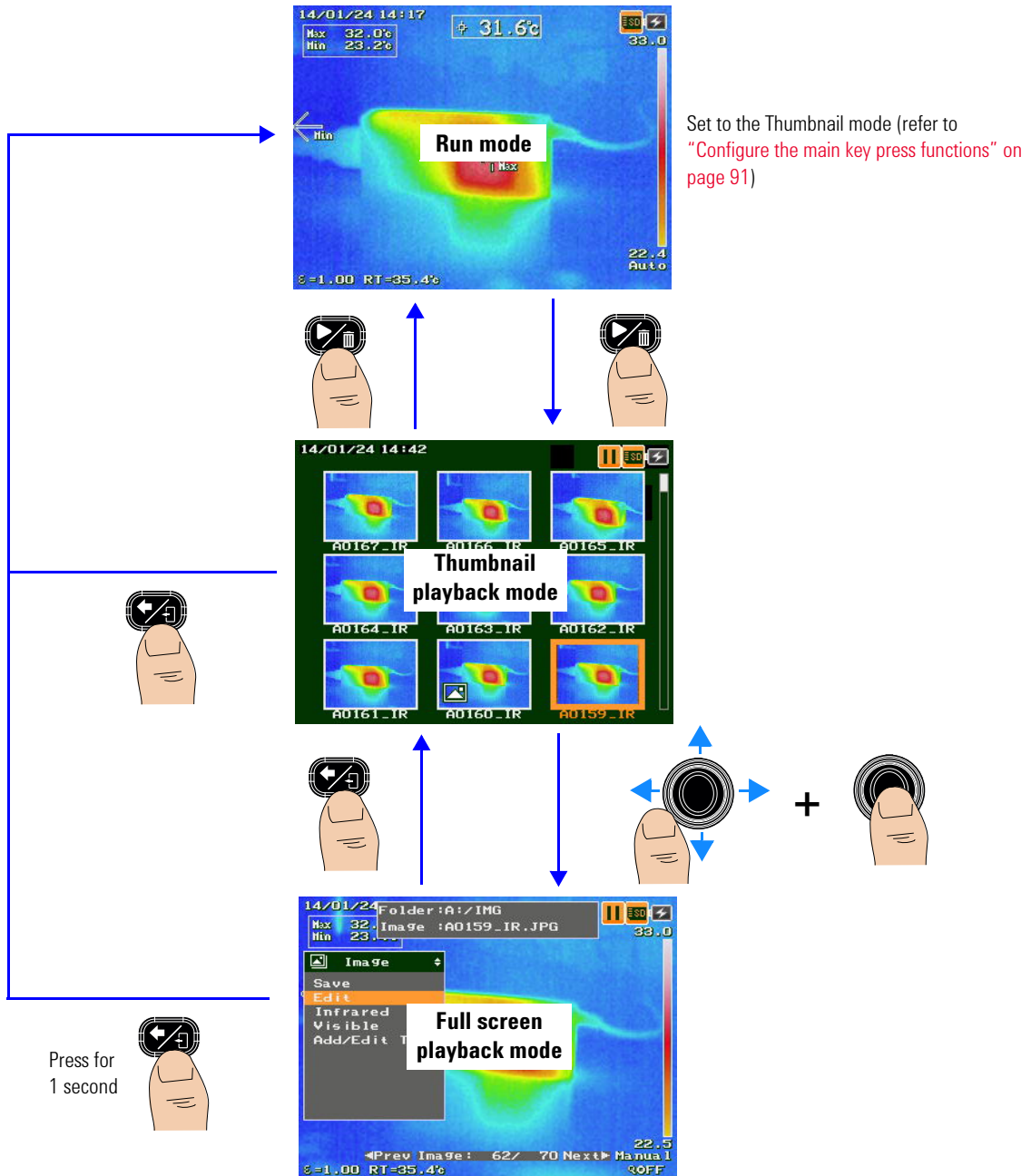

Thumbnail playback mode overview:

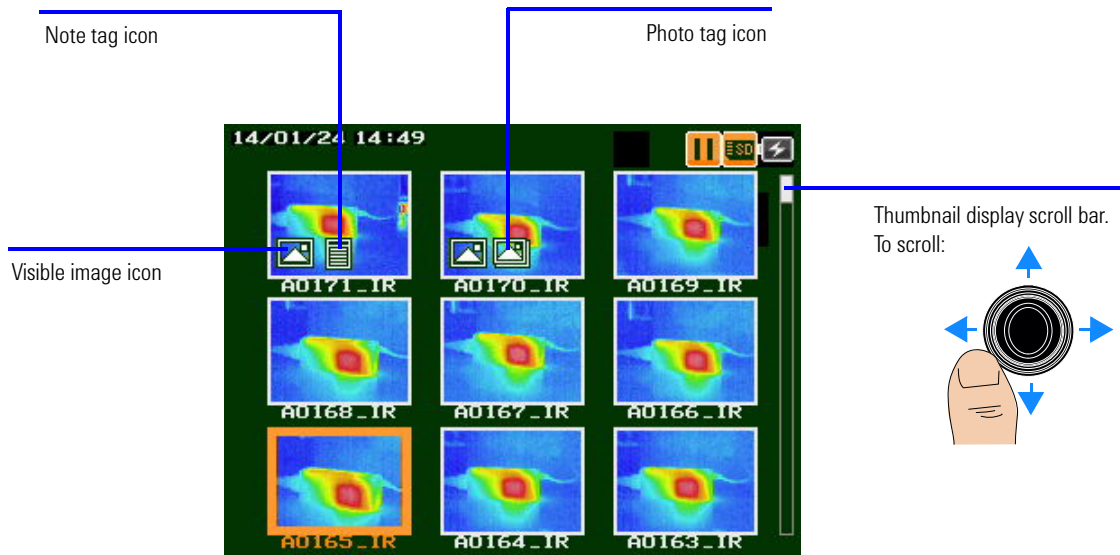

2 Image Capture, Processing, and Measurement Functions
Image Playback

Delete multiple images (Thumbnail playback mode)

1

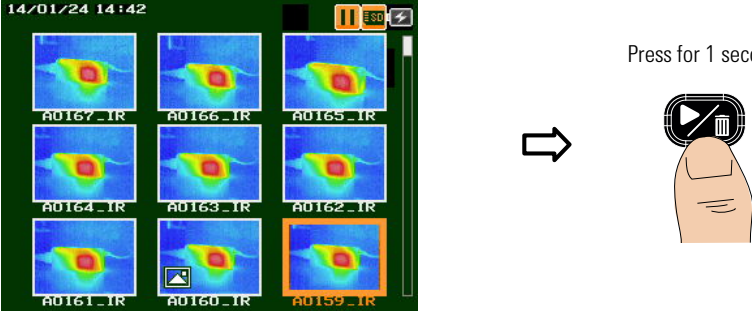

14/01/24 14:42

Press for 1 second

2

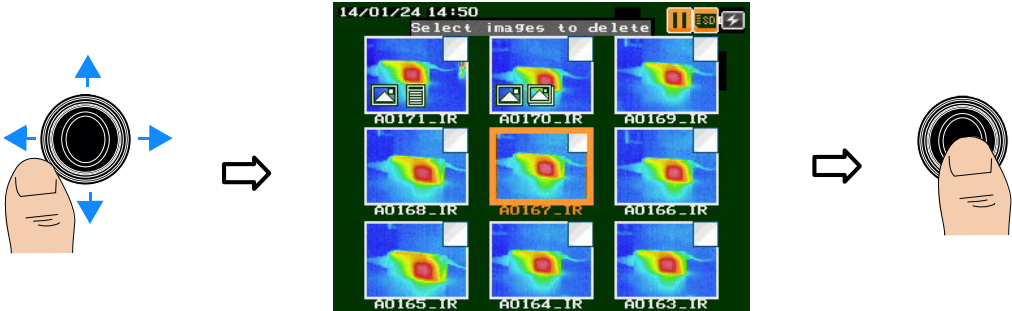

14/01/24 14:50
Select images to delete

2a

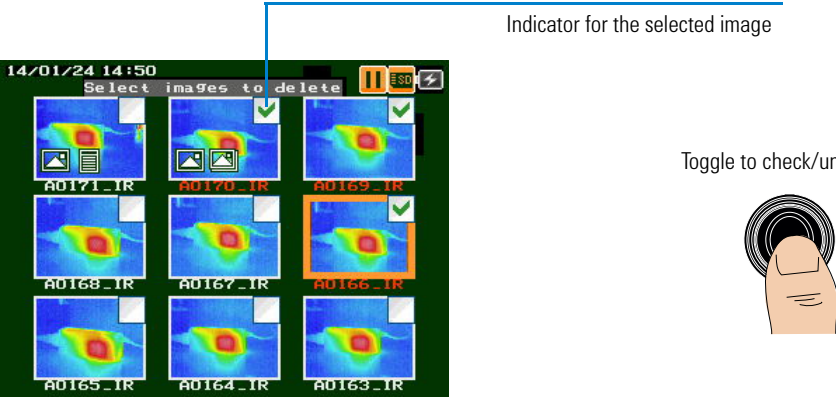

Indicator for the selected image

Toggle to check/uncheck

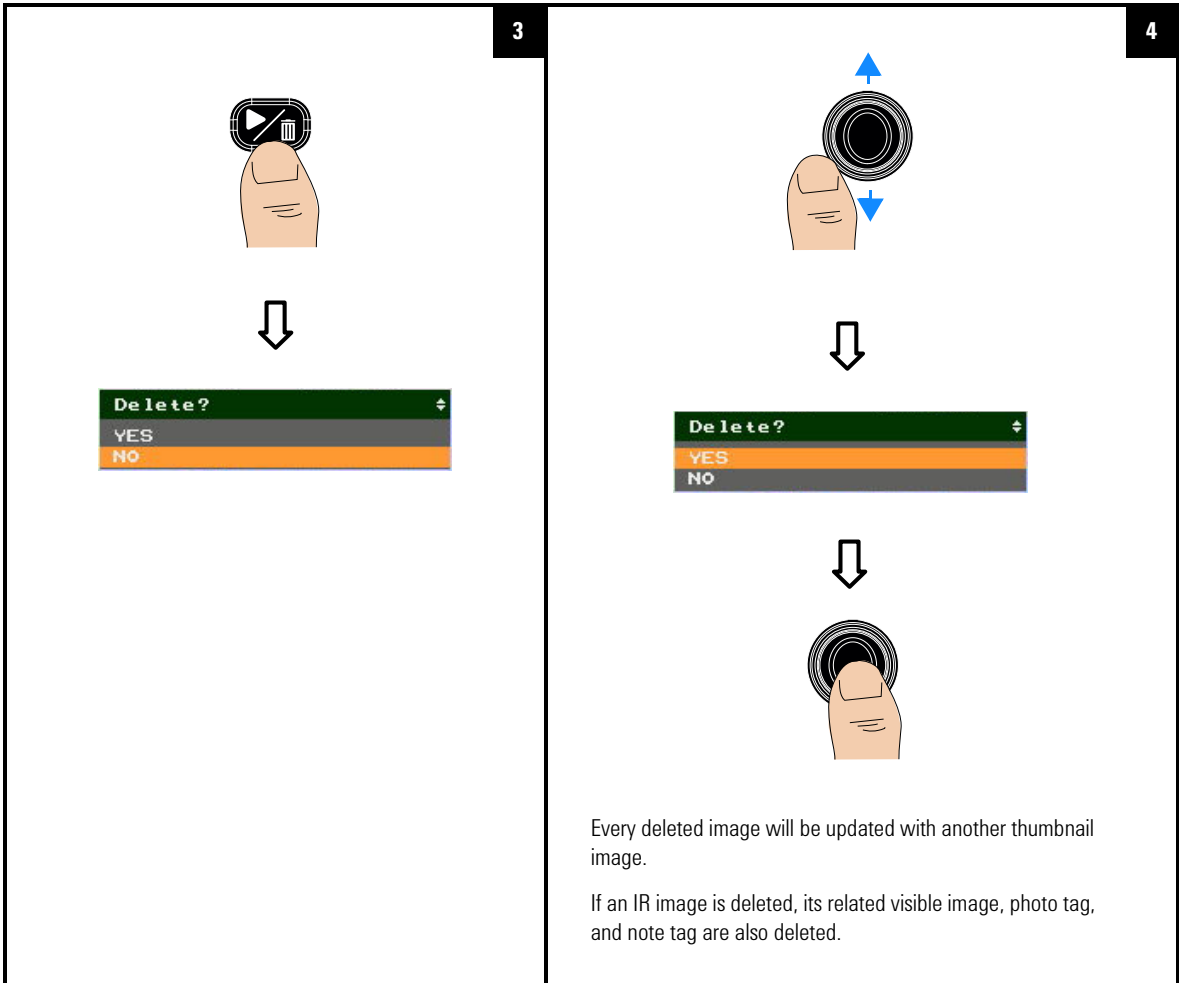

Measurement Controls

The U5855A measurement controls enable you to identify hot/cold spots and to perform thermal analysis on the move, directly on the camera.

Set the temperature range

You can set auto range or manual range (-20 to 120 °C or 0 to 350 °C) for temperature measurement.

If the maximum temperature (within 80% of the image center area) meets the following conditions, auto ranging will occur:

- > 120 °C: Automatically switches from the lower range (-20 to 120 °C) to the upper range (0 to 350 °C).
- < 108 °C: Automatically switches from the upper range (0 to 350 °C) to the lower range (-20 to 120 °C).

Auto ranging for these conditions also applies in the auto scaling mode.

In the manual scaling mode, the temperature span of the temperature scale sets the threshold for auto ranging to occur.

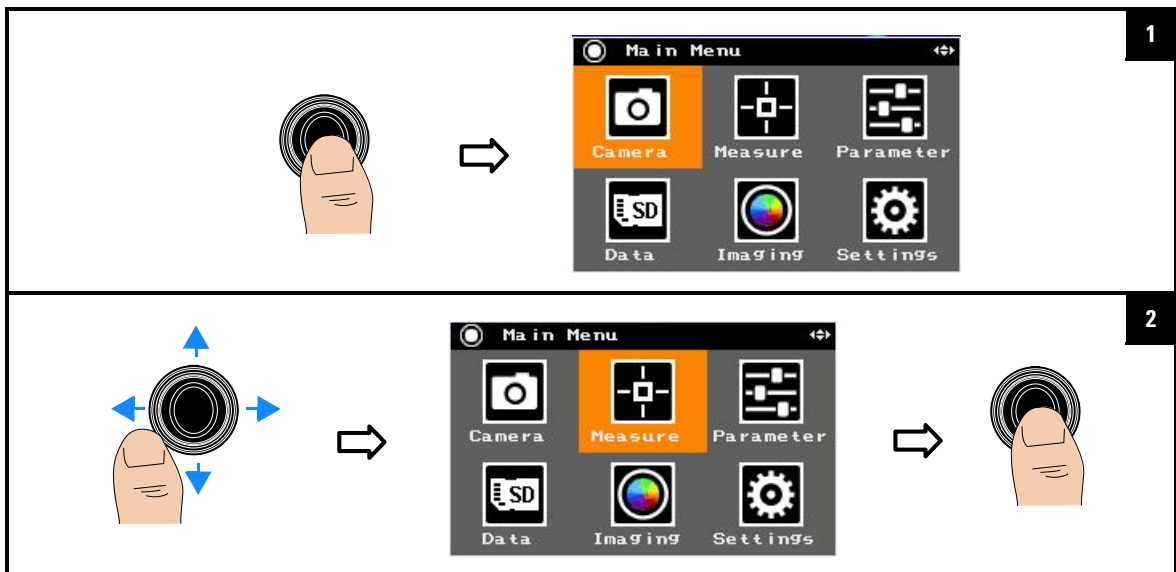

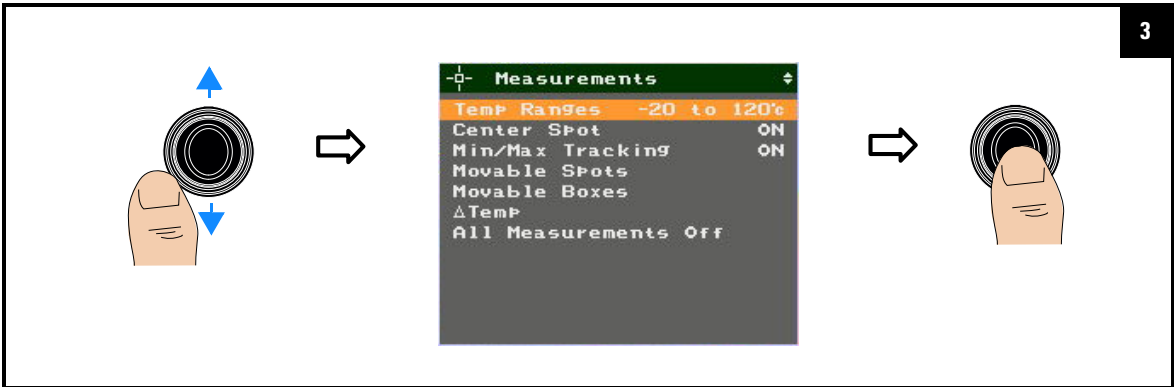

To enable/disable auto range

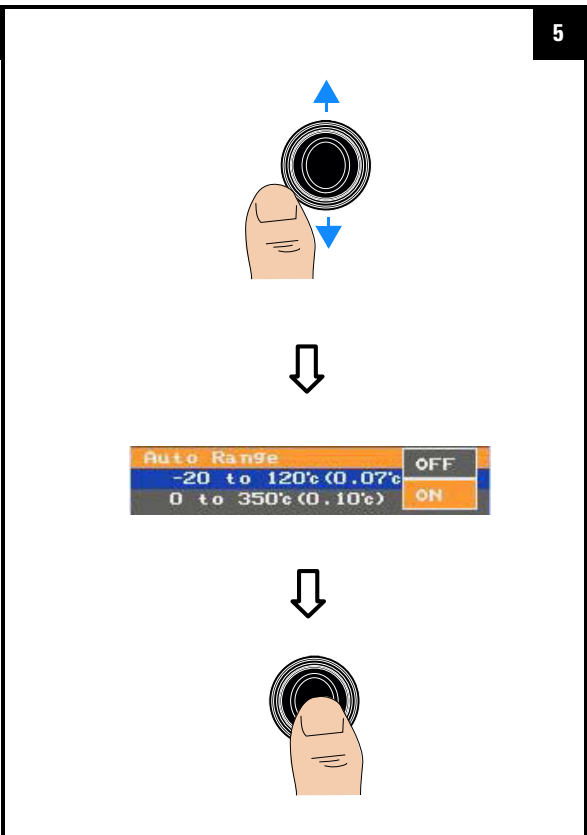
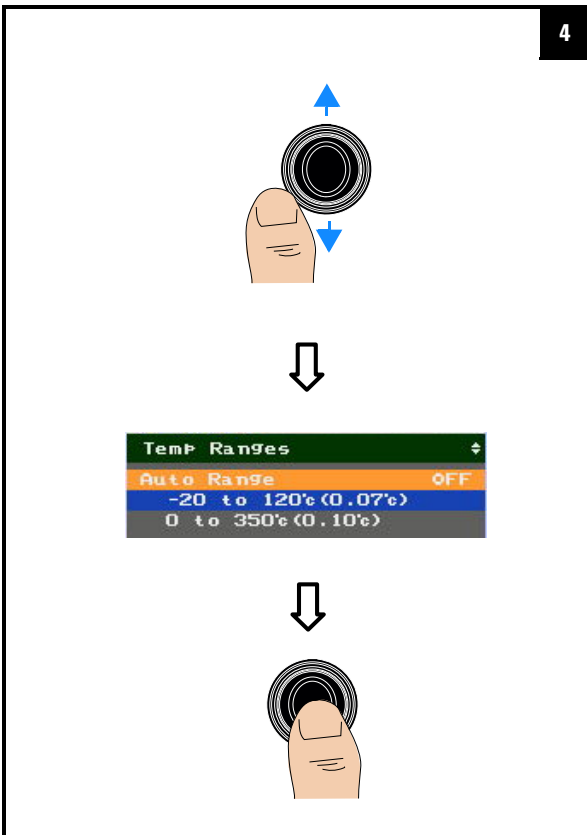

2 Image Capture, Processing, and Measurement Functions

Measurement Controls

To select a manual range (auto range disabled)

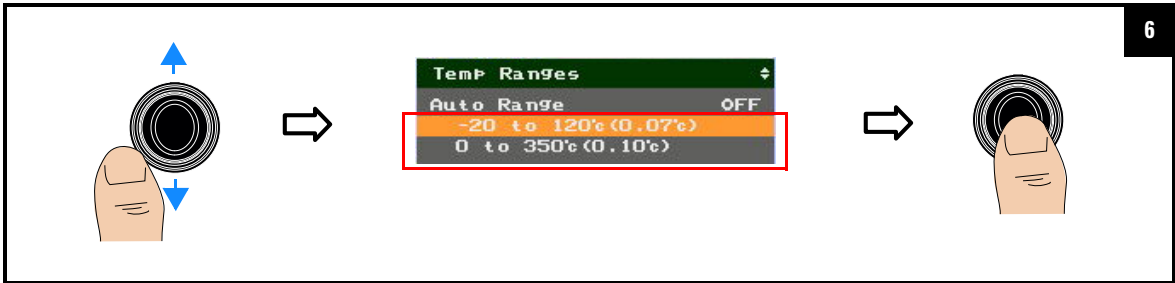

Set the center spot

You can enable or disable the center spot cursor which measures the temperature at the center of the IR image.

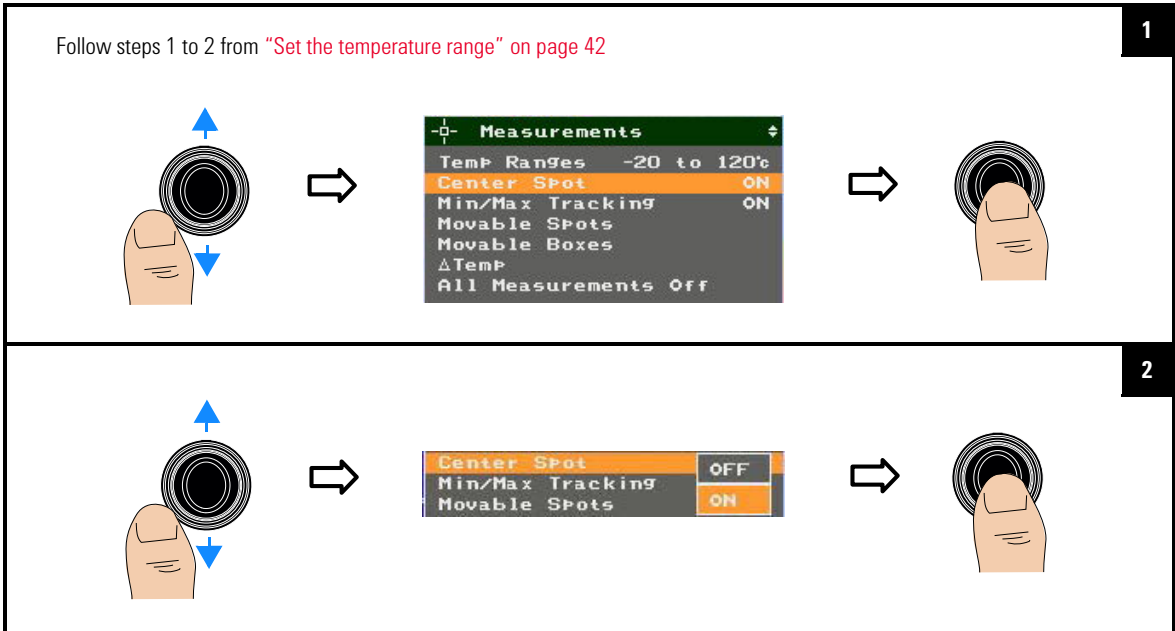

Set the max/min tracking

This function tracks the maximum and minimum temperature within the full IR image.

1

Follow steps 1 to 2 from "Set the temperature range" on page 42

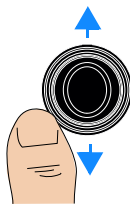
→

Measurements

Temp Ranges -20 to 120°

Center Spot ON

Min/Max Tracking ON

Movable Spots

Movable Boxes

ΔTemp

All Measurements Off

→

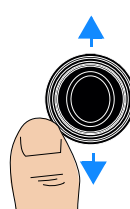

2

→

Min/Max Tracking OFF

Movable Spots

Movable Boxes ON

→

3

Max/Min measurements

Max point cursor

Min point cursor

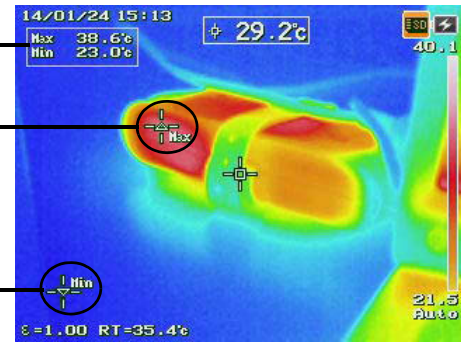

2 Image Capture, Processing, and Measurement Functions

Measurement Controls

Set the moveable spots and boxes

You can enable measurement spots and boxes to browse and detect the hot/cold areas of the IR image. You can allocate boxes at specific areas of the IR image to perform max, min, and average temperature measurements within the areas. The box size can be adjusted.

To set a measurement spot

Follow steps 1 to 2 from "Set the temperature range" on page 42

1

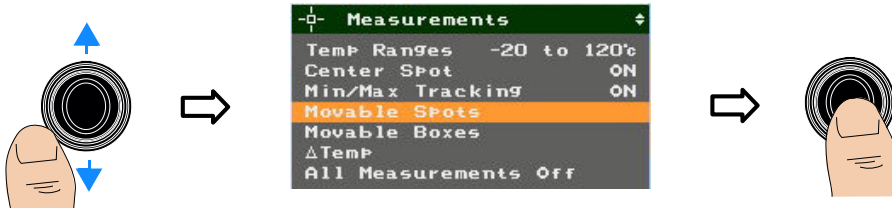

Measurements	
Temp Ranges	-20 to 120°C
Center Spot	ON
Min/Max Tracking	ON
Movable Spots	
Movable Boxes	
ΔTemp	
All Measurements	Off

Select any spot or disable all existing spots:

2

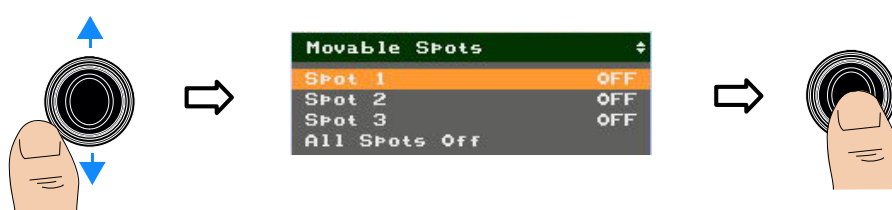

Movable Spots	
Spot 1	OFF
Spot 2	OFF
Spot 3	OFF
All Spots	Off

For example, to enable spot 1:

3

To enable spot 1 moving mode:

4

To move spot 1:

To confirm spot 1 location:

5

To exit spot 1 moving mode:

5a

2 Image Capture, Processing, and Measurement Functions

Measurement Controls

To set a measurement box

1

Follow steps 1 to 2 from "Set the temperature range" on page 42

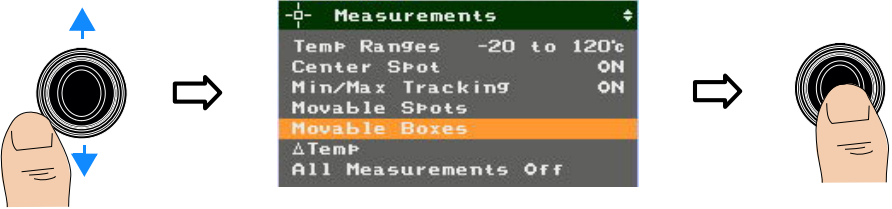

Measurements	
Temp Ranges	-20 to 120°c
Center Spot	ON
Min/Max Tracking	ON
Movable Spots	
Movable Boxes	
ΔTemp	
All Measurements	Off

2

Select any box or disable all existing boxes:

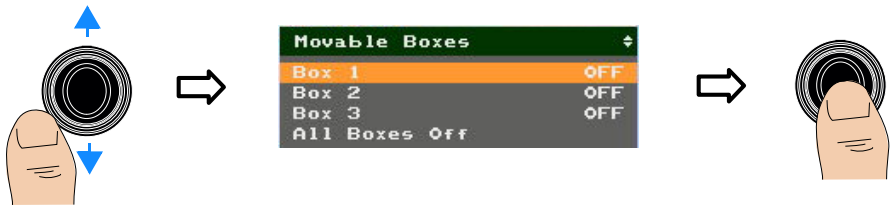

Movable Boxes	
Box 1	OFF
Box 2	OFF
Box 3	OFF
All Boxes	Off

3

For example, to enable box 1:

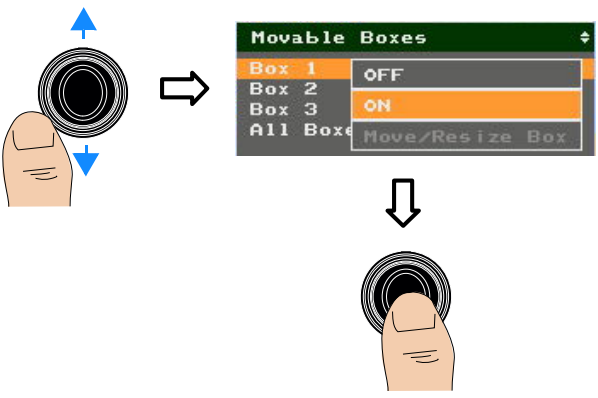

Movable Boxes	
Box 1	OFF
Box 2	OFF
Box 3	ON
All Boxes	Move/Resize Box

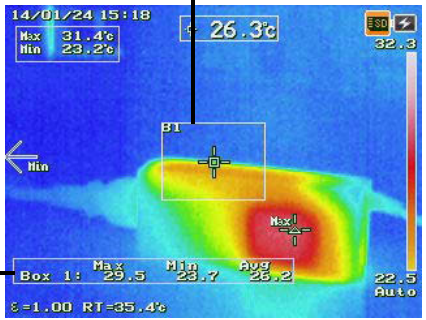

Box 1 cursor

Box 1 max, min, and average readings

To enable box 1 moving mode or adjust the size: 4



Movable Boxes	
Box 1	OFF
Box 2	OFF
Box 3	ON
All Boxes	Move/Resize Box

To move box 1: 5

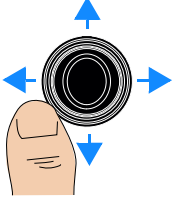

To adjust the size of box 1: 6

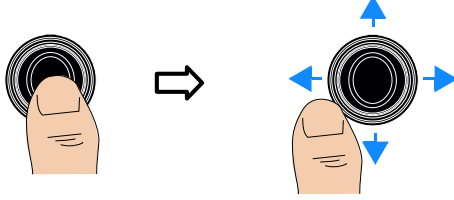

To confirm box 1: 7



To exit box 1 moving mode or size adjustment: 7a

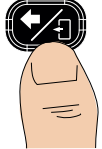

2 Image Capture, Processing, and Measurement Functions

Measurement Controls

Set the delta temperature

You can measure the difference between two temperature readings – you can select from the spot readings or specify your own reference value.

Follow steps 1 to 2 from "Set the temperature range" on page 42

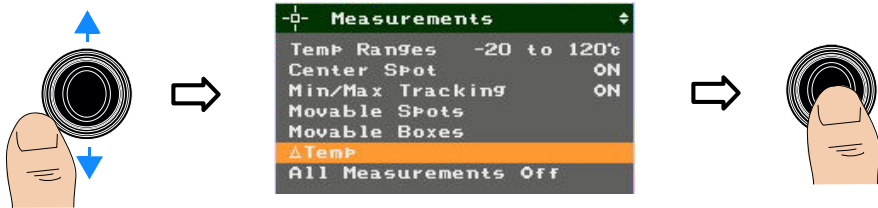
- 

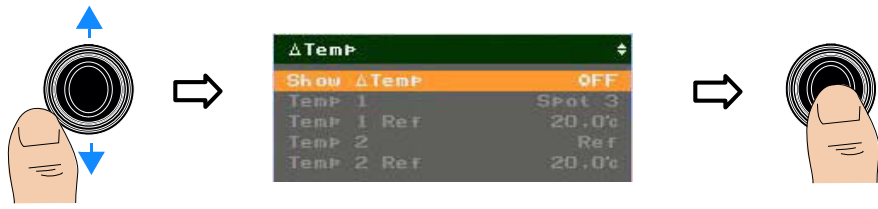
Measurements	
Temp Ranges	-20 to 120°C
Center Spot	ON
Min/Max Tracking	ON
Movable Spots	
Movable Boxes	
ΔTemp	
All Measurements Off	
- 

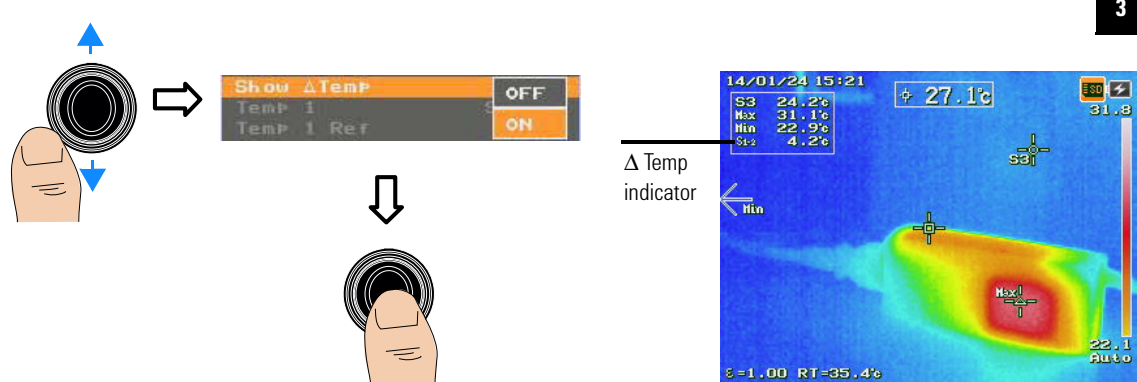
ΔTemp	
Show ΔTemp	OFF
Temp 1	Spot 3
Temp 1 Ref	20.0°C
Temp 2	Ref
Temp 2 Ref	20.0°C
- 

Show ΔTemp	
OFF	ON
Temp 1	
Temp 1 Ref	

Δ Temp indicator

Min

Max

14/01/24 15:21

S3 24.2%

Max 31.1%

Min 22.9%

St2 4.2%

27.1°C

31.8

22.1

ε=1.00 RT=35.4%

Auto

4

5

Select the center spot, spot 1, 2, or 3, or a reference value for Temp 1:

6

If you want to enter a reference value:

Push left/right to move the indicator.
Push up/down to increase/decrease the digits.

7

Repeat the same procedure for **Temp 2**

2 Image Capture, Processing, and Measurement Functions

Measurement Controls

Turn off all measurements

Follow steps 1 to 2 from "Set the temperature range" on page 42

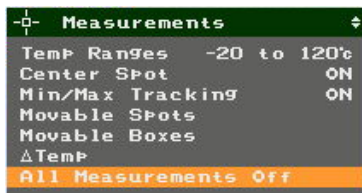
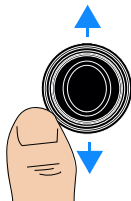

All measurement indicators are removed:

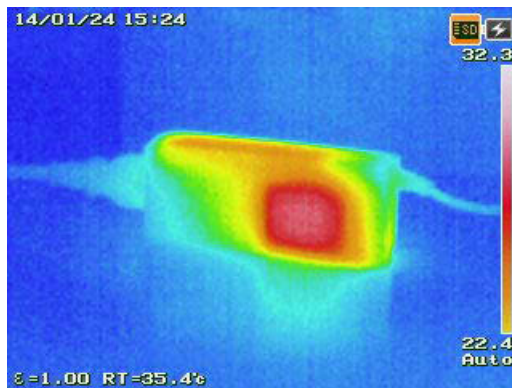

Imaging Controls

The imaging feature allows you to perform a more comprehensive thermal analysis by configuring the IR image display for different environments.

Set the color palette

You can apply a specific color palette for your IR image to improve contrast and clarity when identifying hot/cold areas.

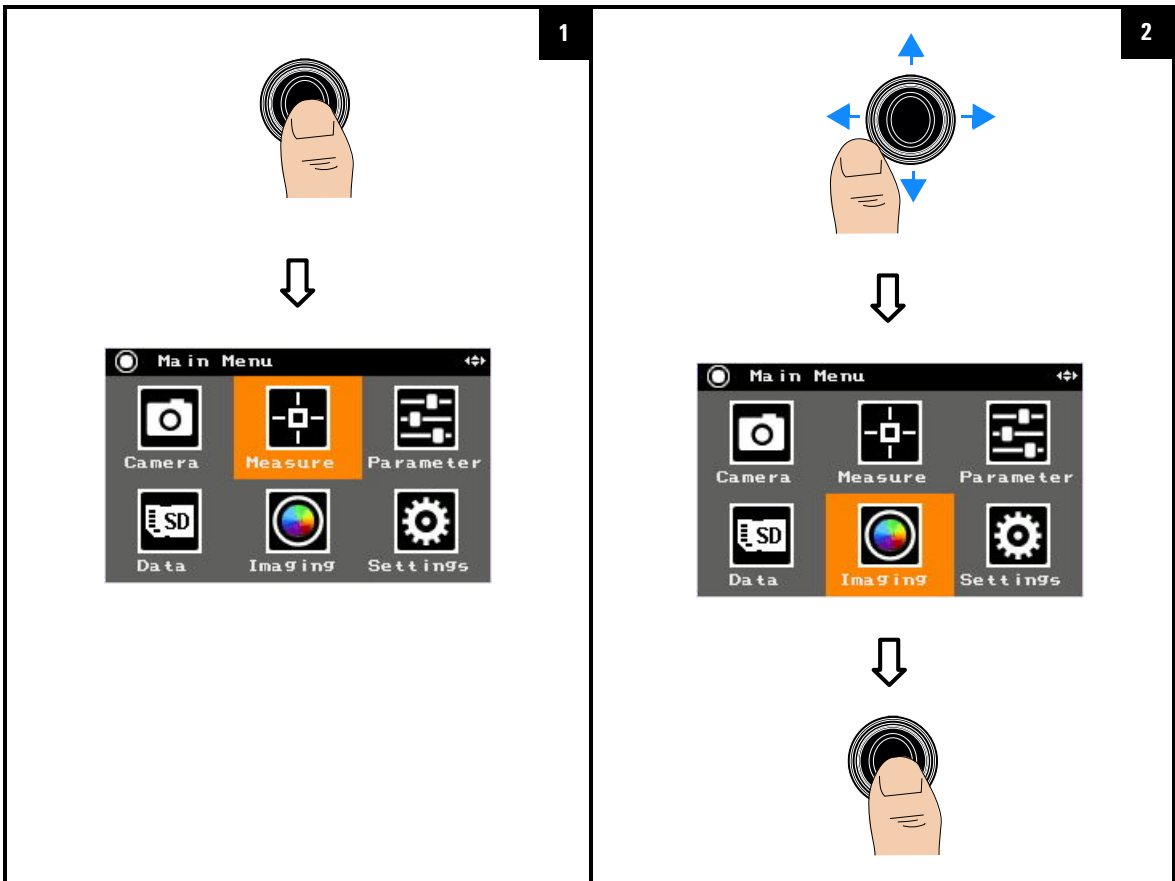

2 Image Capture, Processing, and Measurement Functions

Imaging Controls

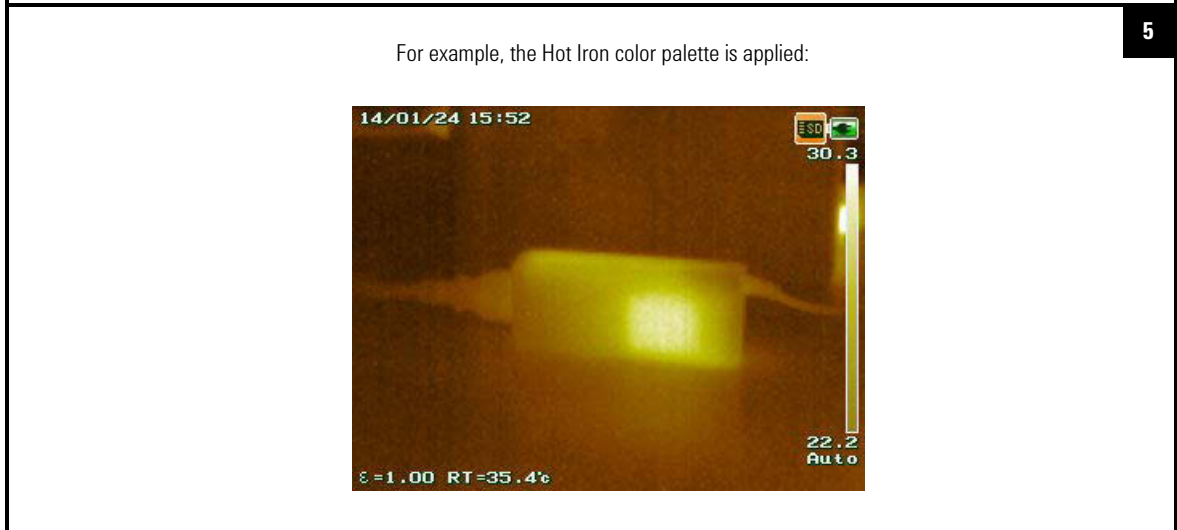
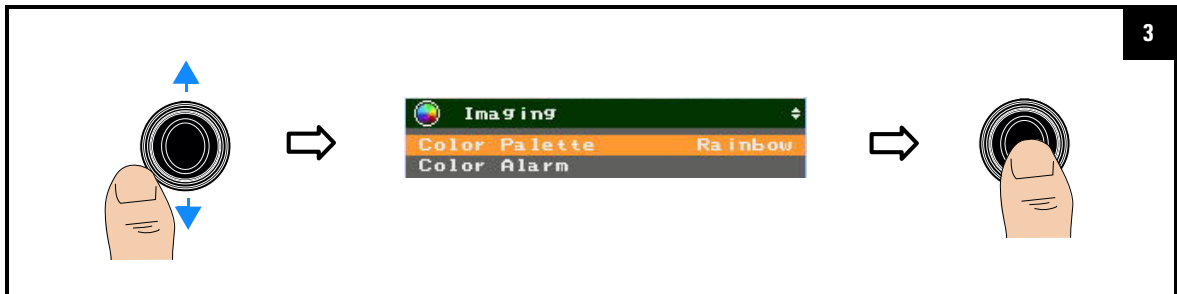



Set the color alarm

The color alarm allows you to set an alarm threshold which only displays IR components on image zones above, below, inside, or outside the alarm threshold.

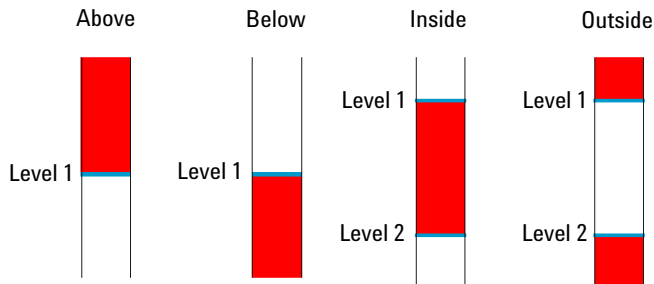
Alarm thresholds



-  Alarm zone (based on selected color palette)
-  Image background zone (based on selected background)

NOTE

In the manual scaling mode, you need to set Level 1 and Level 2 within the temperature span to ensure accurate color display.

To turn on/off the color alarm

Follow steps 1 to 2 from "Set the color palette" on page 53

1



2 Image Capture, Processing, and Measurement Functions

Imaging Controls

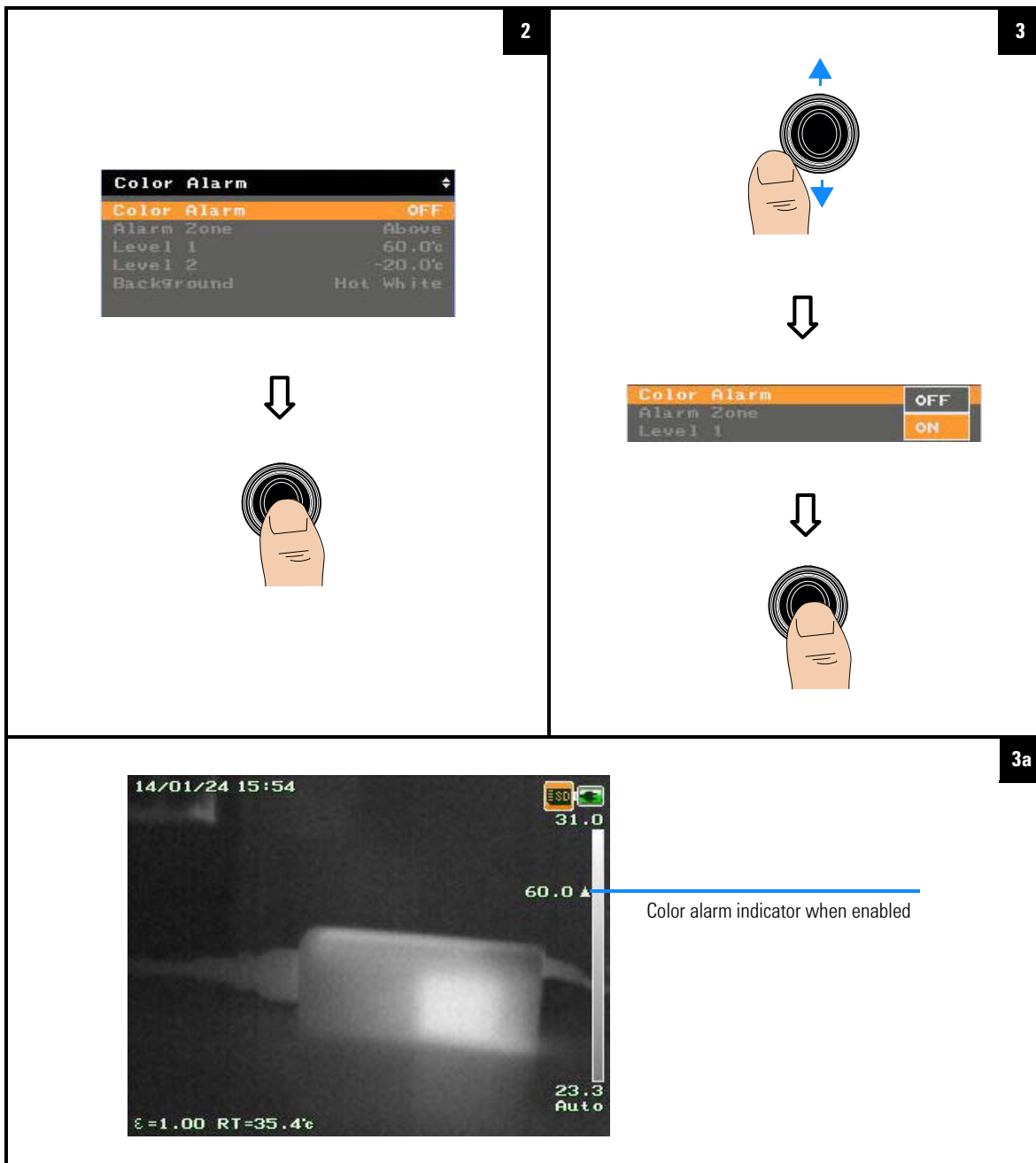

To set the alarm threshold

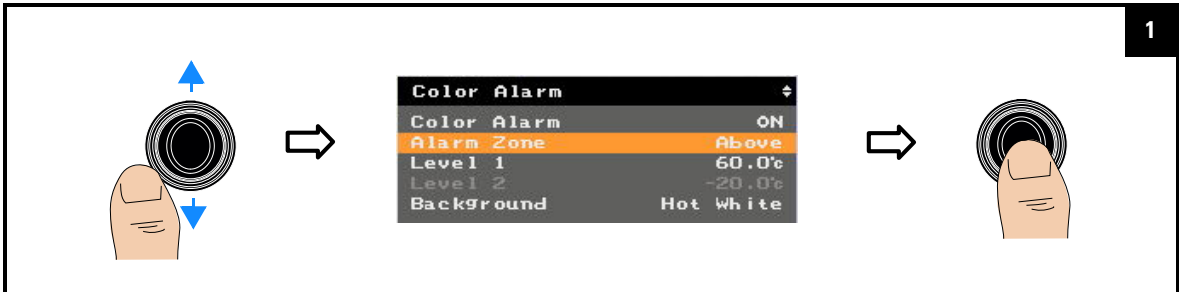

To set the alarm threshold level



2 Image Capture, Processing, and Measurement Functions

Imaging Controls

2



Push left/right to move the indicator.
Push up/down to increase/decrease the digits.

If you have selected the **Inside** or **Outside** threshold, repeat the same procedure to enter the value for **Level 2**

To set the image background

1



2

Select the background type:



Digital Zoom

You can zoom in to expand the view of certain areas of the image at a 1× to 4× ratio.

To set the zoom ratio

1

Press for 1 second



2



2a

To change and confirm the zoom ratio:

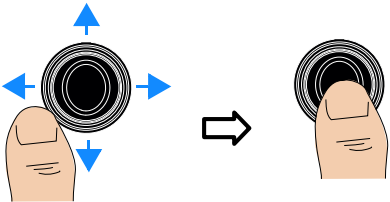

To exit:



In run mode, the zoom area is always at the center of the image



Zoom area

Zoom ratio value

2 Image Capture, Processing, and Measurement Functions

Digital Zoom

To pan (move) the zoom area

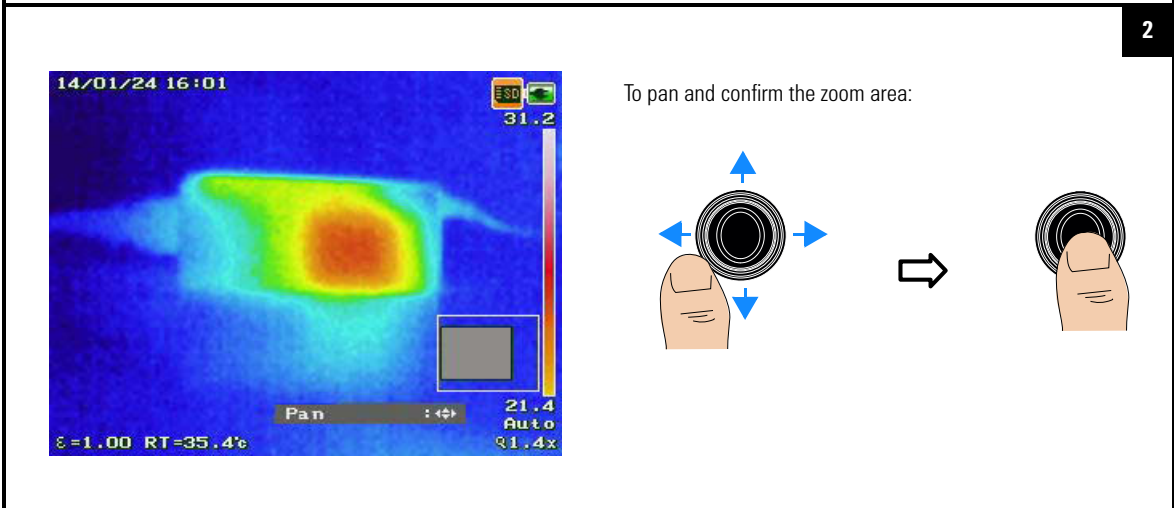
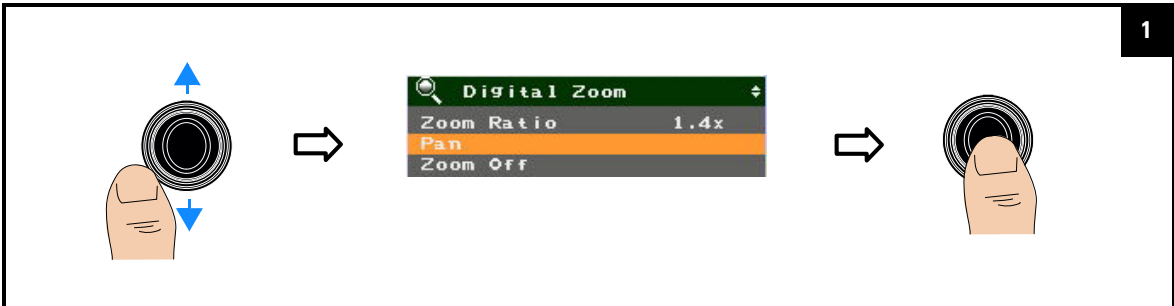

To disable zoom



Parameter Controls

These controls enable you to improve the accuracy of your temperature measurements by making corrections or compensations to the emissivity, reflected temperature, object distance, ambient temperature, humidity, and transmissivity.

Below illustrates a model of the IR emission energy received by the U5855A.

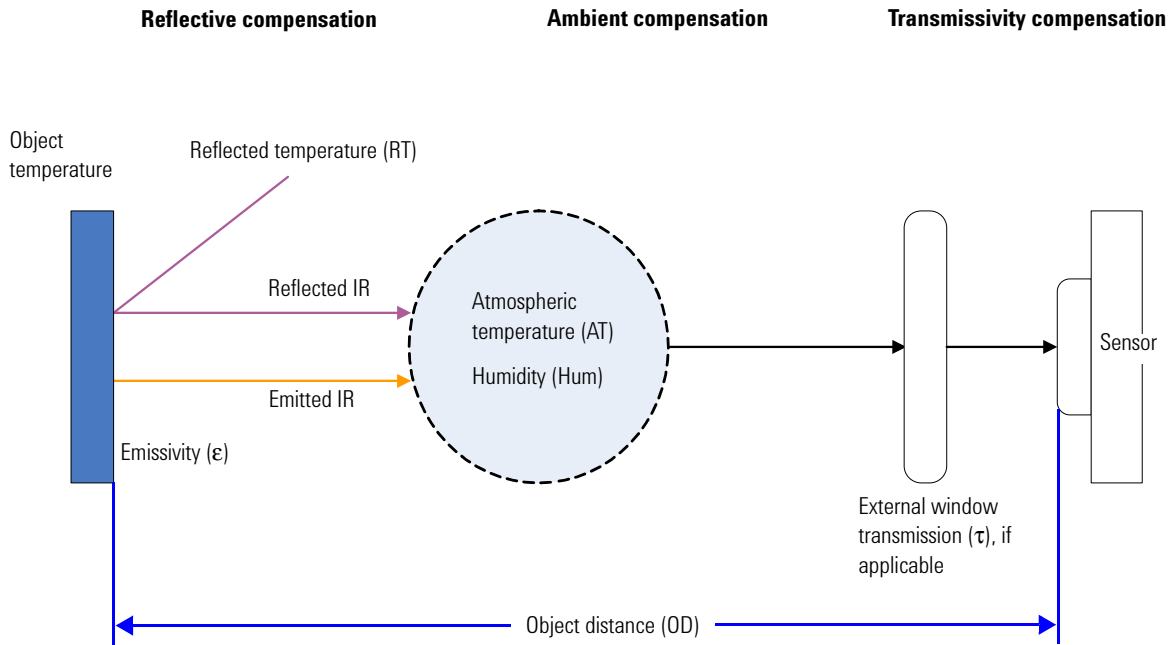

2 Image Capture, Processing, and Measurement Functions Parameter Controls

Set the emissivity (ϵ)

Emissivity is the radiation of energy from the surface of target objects. Objects with high emissivity will produce more accurate temperature measurements than objects with low emissivity. You will need to adjust the emissivity values to compensate for the measurement accuracy of objects with low emissivity.

NOTE

Emissivity setting is not supported during image logging.

To enter an emissivity value

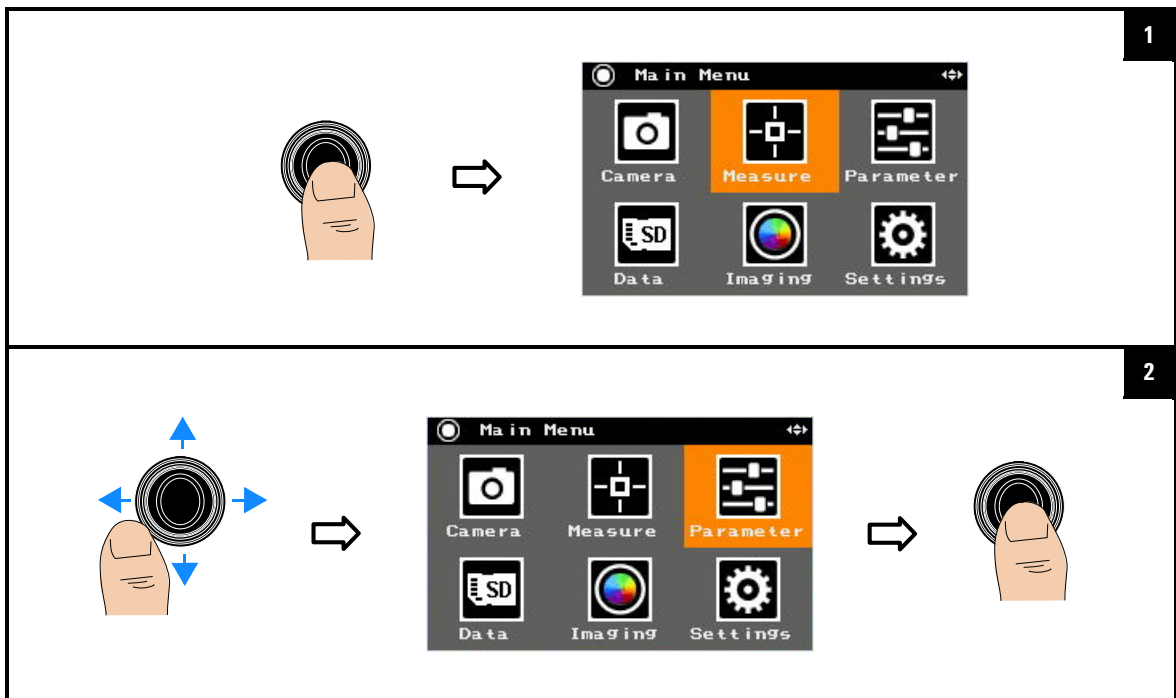

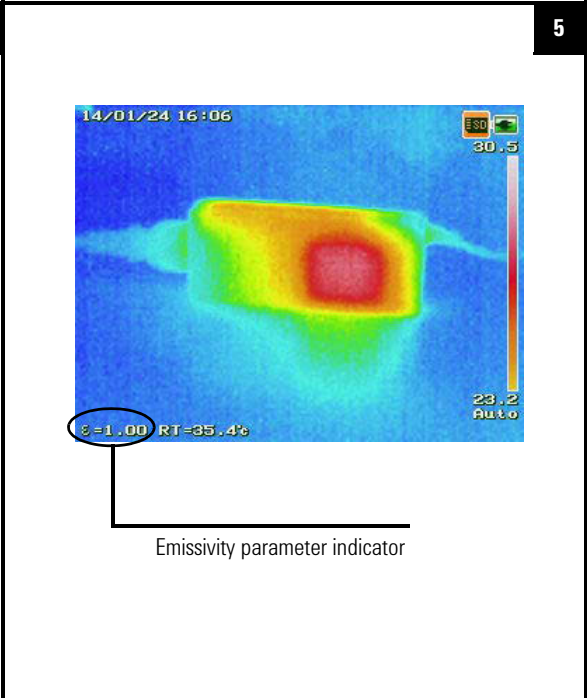
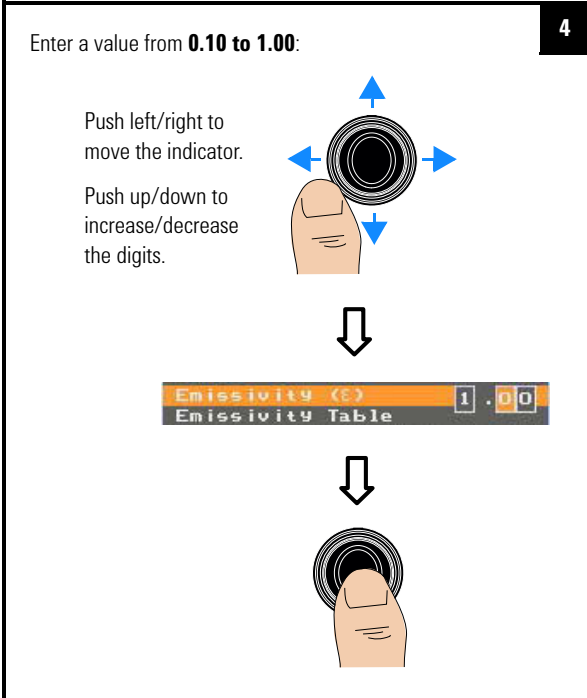
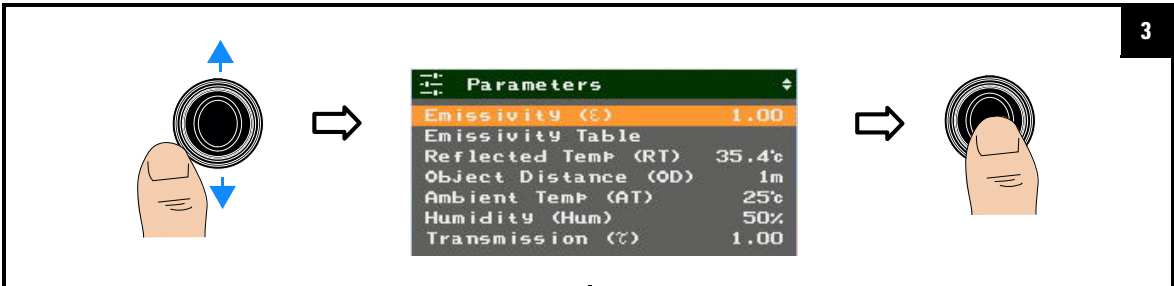

To select a common emissivity value

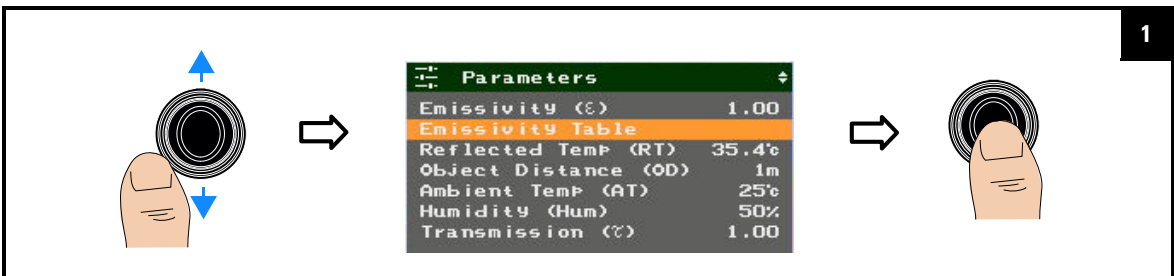

2 Image Capture, Processing, and Measurement Functions Parameter Controls



Table 2-1 Emissivity table

Common item	Emissivity value	Common item	Emissivity value
Iron (polished)	0.10	Paint (typical)	0.94
Iron (oxidized)	0.70	Brick	0.93
Aluminum (oxidized)	0.15	Paper	0.90
Stainless steel (polished)	0.20	Clay	0.92
Stainless steel (oxidized)	0.80	Graphite (carbon)	0.95
Copper (oxidized)	0.40	Glass	0.90
Nickel (oxidized)	0.37	Rubber	0.90
Brass (oxidized)	0.64	Concrete	0.92
Snow	0.85	Skin	0.98
Cloth	0.90	Water	0.96

Set the reflected temperature (RT)

RT of the target object or around the camera can be corrected to obtain a more accurate temperature measurement especially for low-emissivity objects.

You can manually enter an RT value or run the RT calibration (RT Cal) depending on your environment, as listed in the following examples.

- When the RTs of the object and around the camera are equal, for example indoor measurement, the RT is set up by executing RT Cal.
- When the RTs of the object and around the camera are not equal, for example when an outdoor object is measured from indoor, the outdoor RT value is entered manually.
- When the source of reflection exists around an object, the temperature of the source of reflection is entered manually. For example when the object inside a furnace is measured, the inside of the furnace is the source of reflection.

NOTE

RT Cal cannot be executed during freeze mode and image logging.

2 Image Capture, Processing, and Measurement Functions Parameter Controls

To enter an RT value

Follow steps 1 to 2 from "To enter an emissivity value" on page 62

1

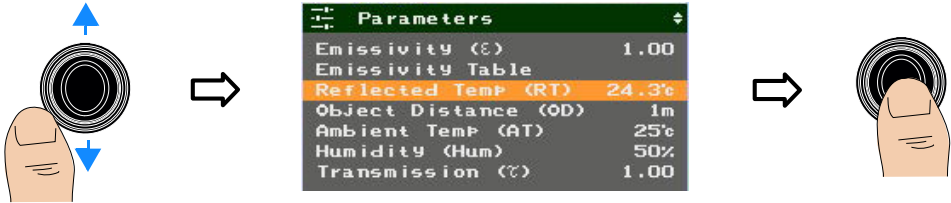

Parameters

Emissivity (ε)	1.00
Emissivity Table	
Reflected Temp (RT)	24.3%
Object Distance (OD)	1m
Ambient Temp (AT)	25%
Humidity (Hum)	50%
Transmission (τ)	1.00

2



Reflected Temp (RT)

Reflected Temp (RT)	
Reflected Temp	24.3%
RT Cal (Environment)	
RT Cal (Source)	

3

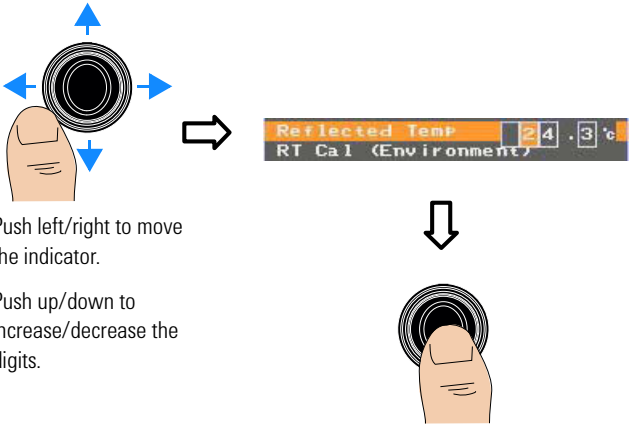

Push left/right to move the indicator.

Push up/down to increase/decrease the digits.

4



RT parameter indicator

To run RT Cal for environmental reflection correction

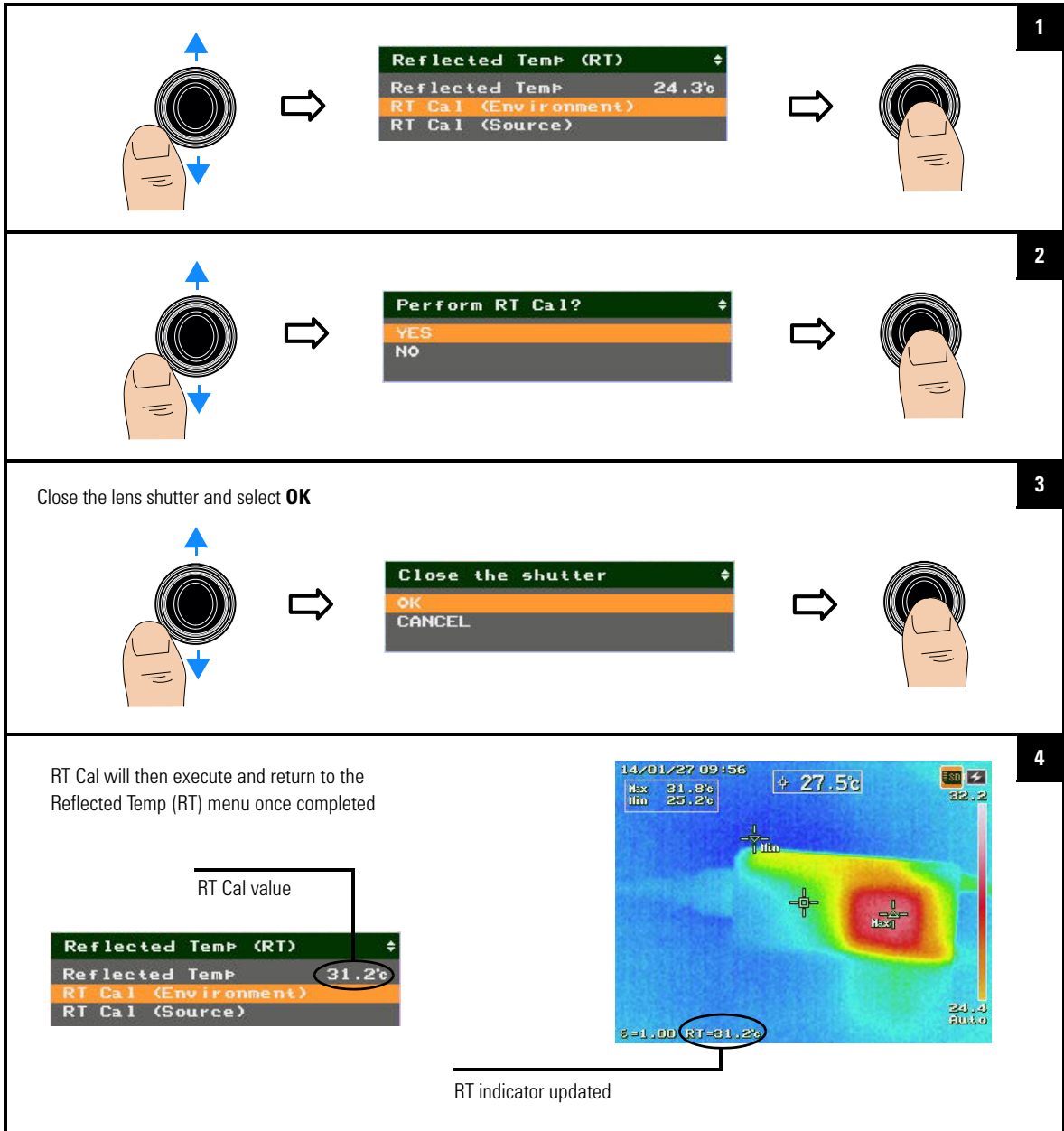

2 Image Capture, Processing, and Measurement Functions Parameter Controls

To run RT Cal for reflection source correction

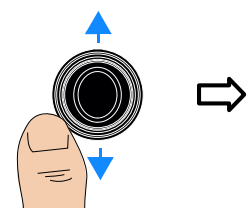

Reflected Temp (RT)	
Reflected Temp	32.2°
RT Cal (Environment)	
RT Cal (Source)	

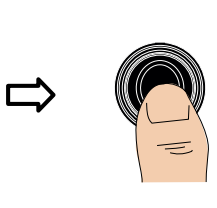

1

If you know the temperature of the reflection source, you may enter the value. If not, select **YES** to run the calibration to obtain the temperature.

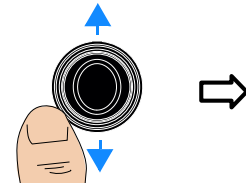

Background Compensation	
YES	
NO	
24.5°	

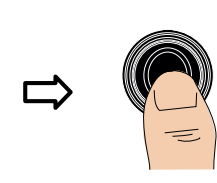

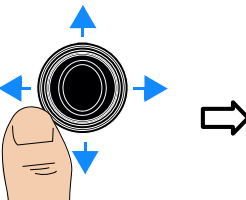

Background Compensation	
YES	
NO	
25.8°	

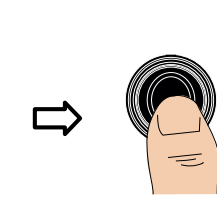

Push left/right to move the indicator.
Push up/down to increase/decrease the digits.

OR

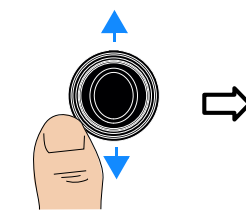

Background Compensation	
YES	
NO	
25.0°	

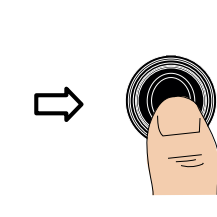

2

When completed, it will return to the Reflected Temp (RT) menu

Value updated

RT indicator updated

3

Set the object distance (OD), ambient temperature (AT), and humidity (Hum)

You can perform compensation for ambient parameters (OD, AT, Hum) to correct atmospheric errors in your temperature measurements.

NOTE

Ambient parameter settings are not supported in the freeze, playback, and image logging modes.

Follow steps 1 to 2 from "To enter an emissivity value" on page 62.

Select **Object Distance (OD)/Ambient Temp (AT)/Humidity (Hum)**:

1

Parameters	
Emissivity (E)	1.00
Emissivity Table	
Reflected Temp (RT)	30.3%
Object Distance (OD)	1m
Ambient Temp (AT)	25%
Humidity (Hum)	50%
Transmission (T)	1.00

2 Image Capture, Processing, and Measurement Functions Parameter Controls

• OD: **1 to 1000 m**
• AT: **-15 to 50 °C**
• Hum: **0 to 100%**

Push left/right to move the indicator.
Push up/down to increase/decrease the digits.

2

Ambient parameter indicators

3

Ambient parameter indicators

Set the transmissivity (τ)

Some IR energy may be lost when transmitted through an external window; this transmissivity error must be corrected to improve the accuracy of your temperature measurements.

NOTE

Transmissivity setting is not supported in the freeze, playback, and image logging modes.

Follow steps 1 to 2 from "To enter an emissivity value" on page 62

1

Parameters	
Emissivity (E)	1.00
Emissivity Table	
Reflected Temp (RT)	30.3%
Object Distance (OD)	100m
Ambient Temp (AT)	25c
Humidity (Hum)	50%
Transmission (T)	1.00

Enter a value from **0.10 to 1.00**:

2

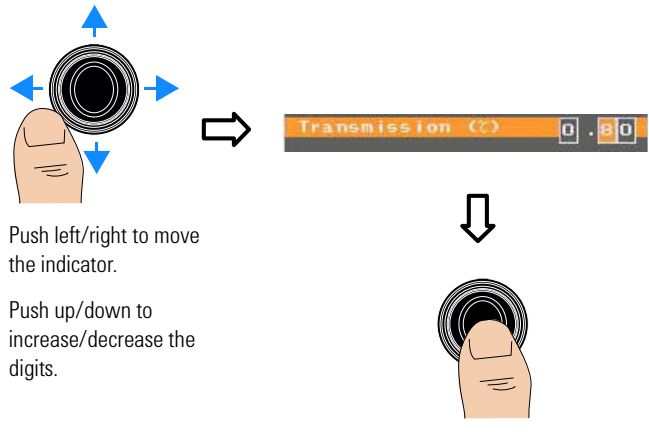

Push left/right to move the indicator.

Push up/down to increase/decrease the digits.

3

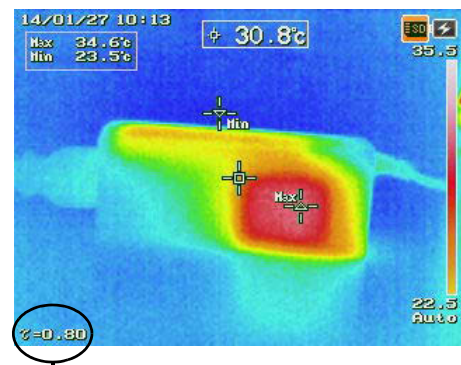

14/01/27 10:13
Max 34.6°C
Min 23.5°C
30.8°C
ESD
35.5
22.5
Auto
T=0.80

Transmissivity parameter indicator

2 Image Capture, Processing, and Measurement Functions
Parameter Controls

THIS PAGE HAS BEEN INTENTIONALLY LEFT BLANK.

3

Data Management and System-Related Functions

Data Management Controls 74

System-Related Settings 84

This chapter guides you on how to configure data and system settings for the U5855A.

3 Data Management and System-Related Functions

Data Management Controls

Data Management Controls

These controls allow you to log images, check the memory status, manage your image folders, and format the SD memory card.

Perform image logging

You can log IR, visible, or fusion images at defined intervals. During logging, folders are automatically created in the SD memory card to store the images. The folder created at the first logging interval will be named LOG_0001, then LOG_0002 at the next interval, and will increase subsequently.

To enable/disable image logging

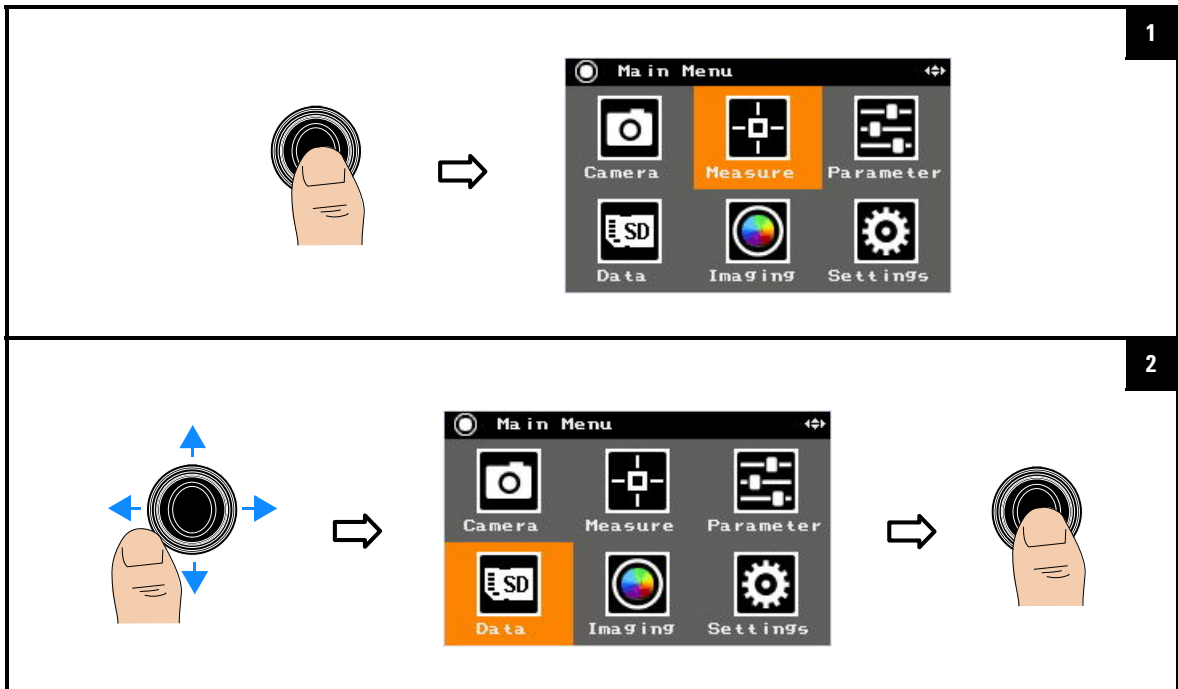

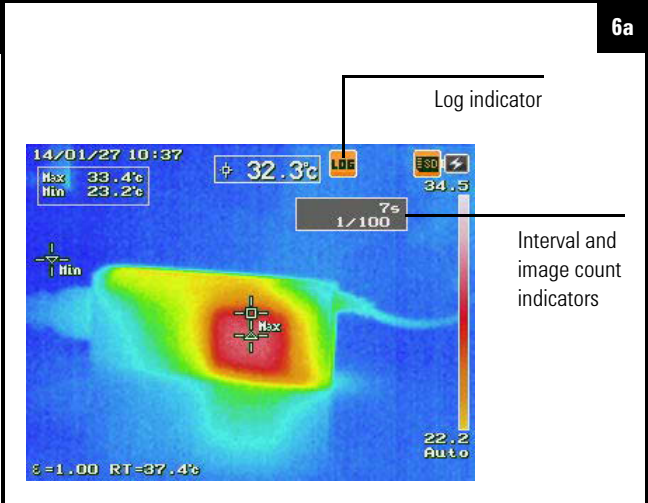
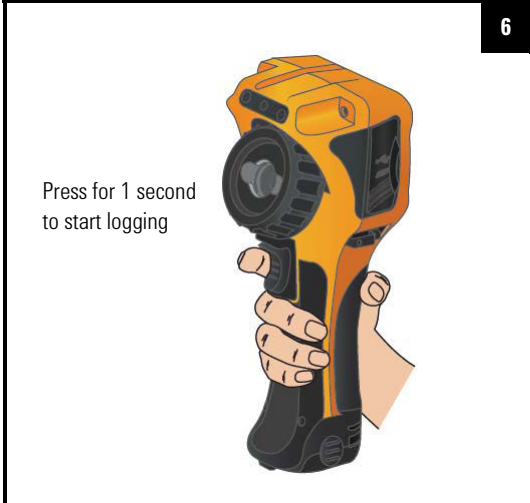
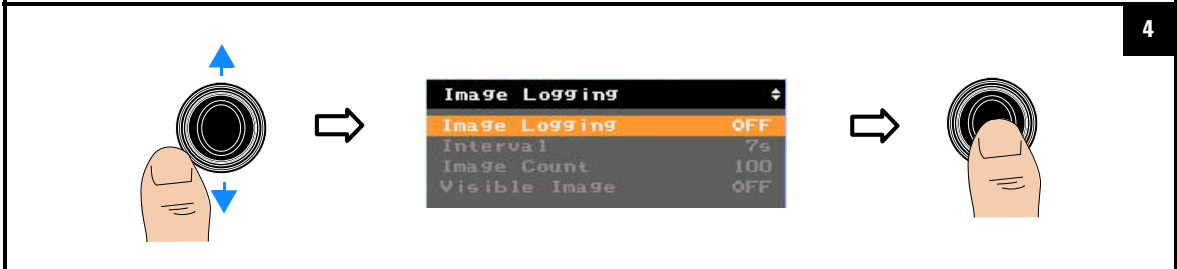
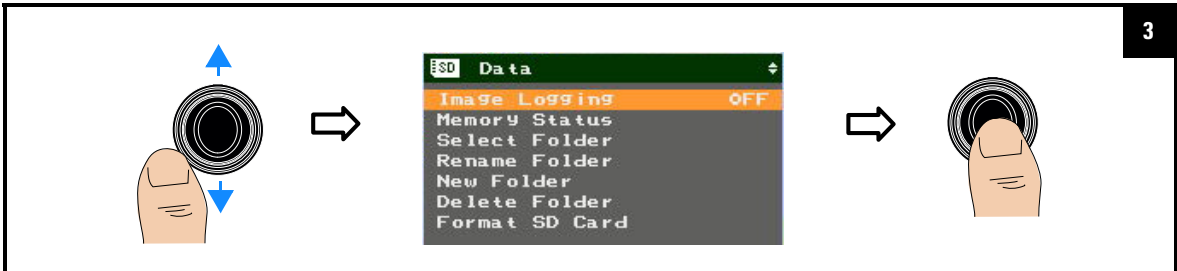

3 Data Management and System-Related Functions

Data Management Controls

To exit logging:

7

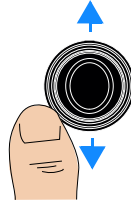

To set the logging interval

1

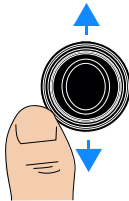

Enter a value from **7 to 3600 seconds**:

2

Push left/right to move the indicator.

Push up/down to increase/decrease the digits.

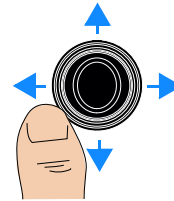

To set the image count

1

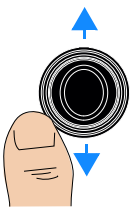



Image Logging	
Image Logging	ON
Interval	7s
Image Count	100
Visible Image	OFF

↓



2

Enter a value from **1 to 1000**:

Push left/right to move the indicator.
Push up/down to increase/decrease the digits.

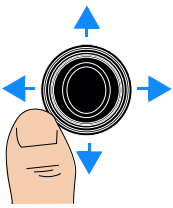



Image Count	500
Visible Image	OFF

↓



To enable/disable logging of visible images

1

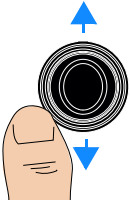



Image Logging	
Image Logging	ON
Interval	7s
Image Count	100
Visible Image	OFF

⇒



3 Data Management and System-Related Functions

Data Management Controls

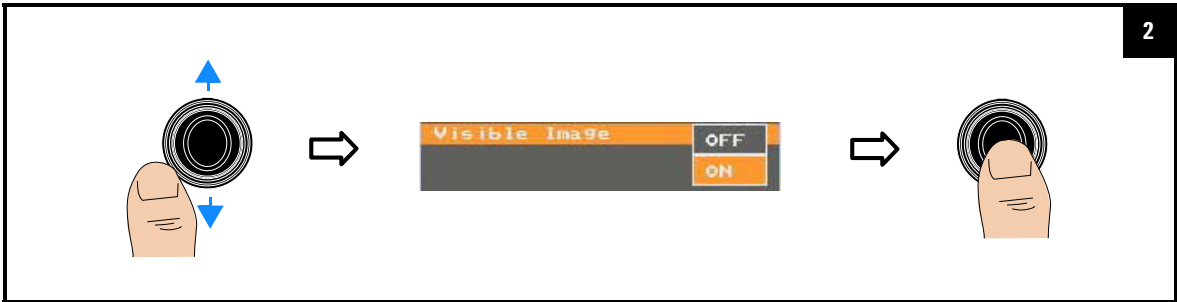

View the SD card memory status

NOTE

This function is not supported during image logging.

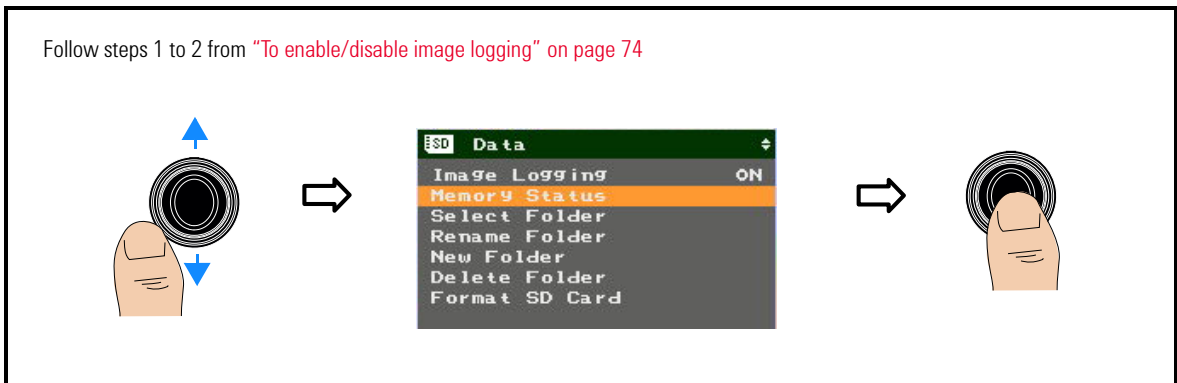

Manage image folders

You can create a new image folder or select, rename, or delete an existing folder for your image saving purposes.

NOTE

This function is not supported during image logging.

To select a folder

Follow steps 1 to 2 from "To enable/disable image logging" on page 74

1

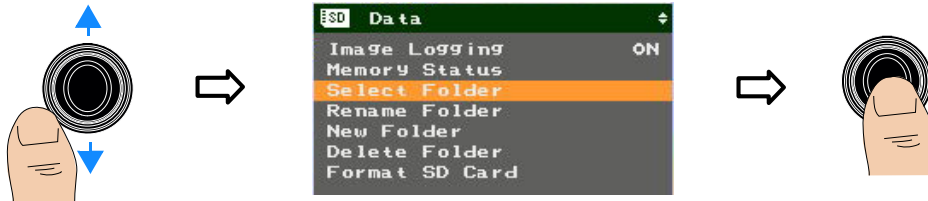

Select an existing folder to use:

2

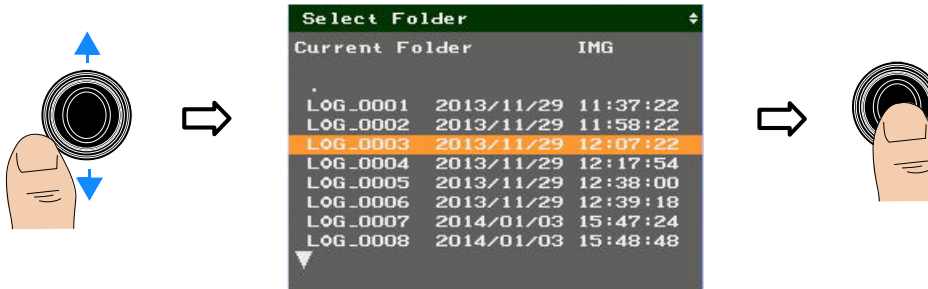

To return to the previous folder list display:

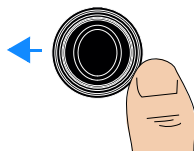

To return to the Data menu:



3 Data Management and System-Related Functions

Data Management Controls

To rename a folder

1

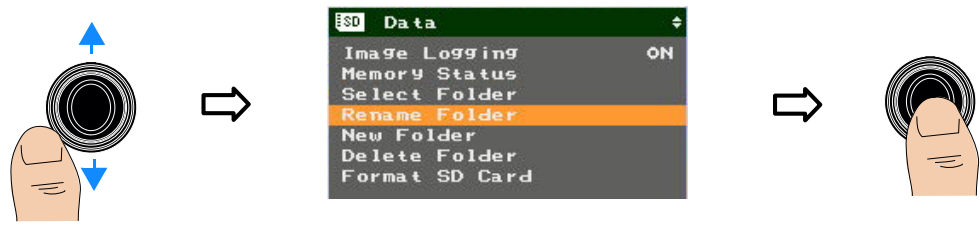

SD Data

Image Logging	ON
Memory Status	
Select Folder	
Rename Folder	
New Folder	
Delete Folder	
Format SD Card	

2

Select an existing folder to rename:

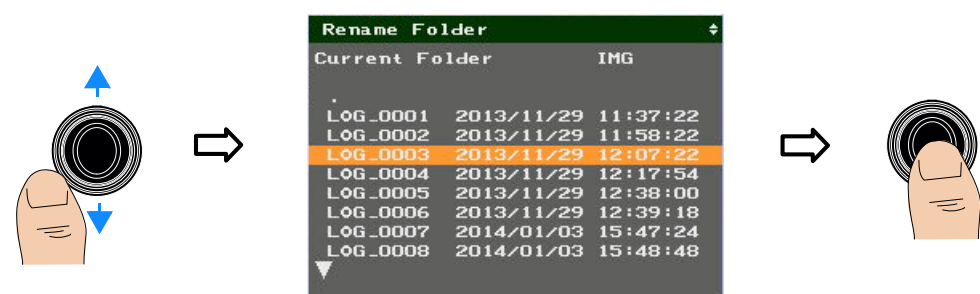

Rename Folder

Current Folder	IMG
.	
LOG_0001	2013/11/29 11:37:22
LOG_0002	2013/11/29 11:58:22
LOG_0003	2013/11/29 12:07:22
LOG_0004	2013/11/29 12:17:54
LOG_0005	2013/11/29 12:38:00
LOG_0006	2013/11/29 12:39:18
LOG_0007	2014/01/03 15:47:24
LOG_0008	2014/01/03 15:48:48

Push left/right to move the indicator.

Push up/down to increase/decrease the digits.

3

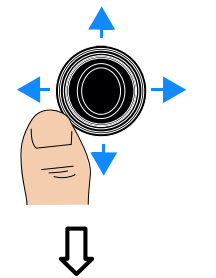

Rename Folder

Current Folder	IMG
Folder Name	LOG_TEST

4

The new folder name will be reflected in the list:



Rename Folder

Current Folder	IMG
.	
LOG_0001	2013/11/29 11:37:22
LOG_0002	2013/11/29 11:58:22
LOG_TEST	2013/11/29 12:07:22
LOG_0004	2013/11/29 12:17:54
LOG_0005	2013/11/29 12:38:00
LOG_0006	2013/11/29 12:39:18
LOG_0007	2014/01/03 15:47:24
LOG_0008	2014/01/03 15:48:48

To create a new folder

1

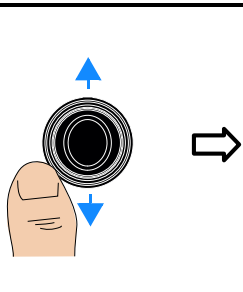

SD Data	
Image Logging	ON
Memory Status	
Select Folder	
Rename Folder	
New Folder	
Delete Folder	
Format SD Card	

2

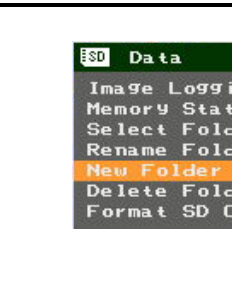

New Folder	
Current Folder	IMG
Folder Name	1 0 2 I M A G E

Push left/right to move the indicator.
Push up/down to increase/decrease the digits.

This will lead you to add another new folder. To exit,



You can view the new folders under the Select Folder menu.

To delete a folder

1

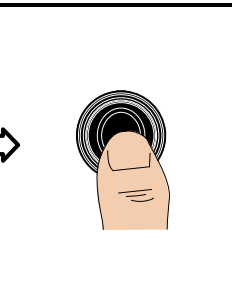

SD Data	
Image Logging	ON
Memory Status	
Select Folder	
Rename Folder	
New Folder	
Delete Folder	
Format SD Card	

3 Data Management and System-Related Functions

Data Management Controls

Select an existing folder to delete:

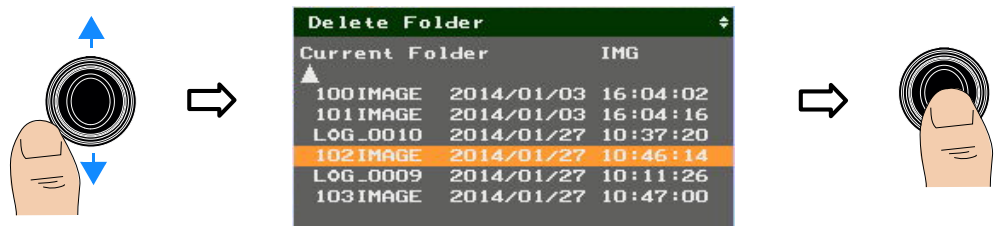

2

Delete Folder			
Current Folder		IMG	
▲	100 IMAGE	2014/01/03	16:04:02
	101 IMAGE	2014/01/03	16:04:16
	LOG_0010	2014/01/27	10:37:20
	102 IMAGE	2014/01/27	10:46:14
	LOG_0009	2014/01/27	10:11:26
	103 IMAGE	2014/01/27	10:47:00



3

Delete selected folder?	
YES	
NO	

Format the SD card

NOTE

This function is not supported during image logging.

Follow steps 1 to 2 from "To enable/disable image logging" on page 74

1

Select **YES** to proceed and return to the Data menu once completed

2

The diagram illustrates the process of formatting an SD card in two steps. Step 1 shows a hand using a rotary controller to navigate through a menu. The menu items are: Image Logging (ON), Memory Status, Select Folder, Rename Folder, New Folder, Delete Folder, and Format SD Card (highlighted). Step 2 shows a hand using a rotary controller to select YES in a confirmation dialog. The dialog asks "Format SD card?" with options YES (highlighted) and NO.

3 Data Management and System-Related Functions

System-Related Settings

System-Related Settings

These settings allow you to make general system configurations for the U5855A.

Configure the Quick Start Tutorial

NOTE

This function is not supported during image logging.

To display the tutorial

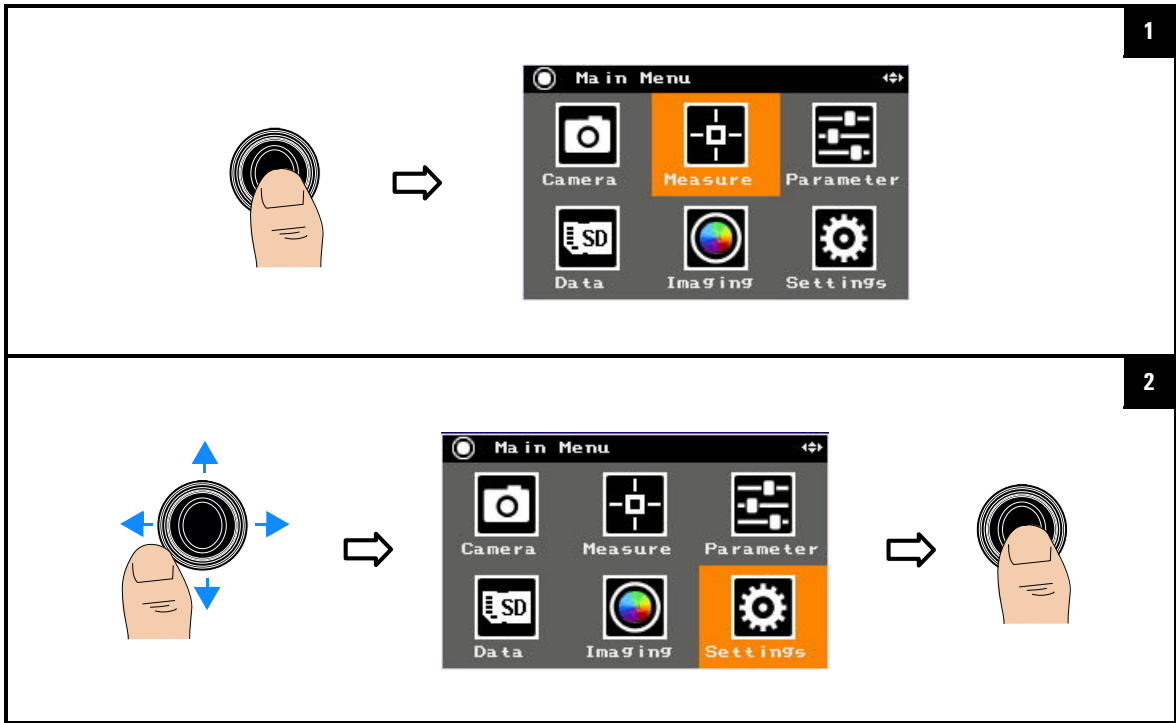

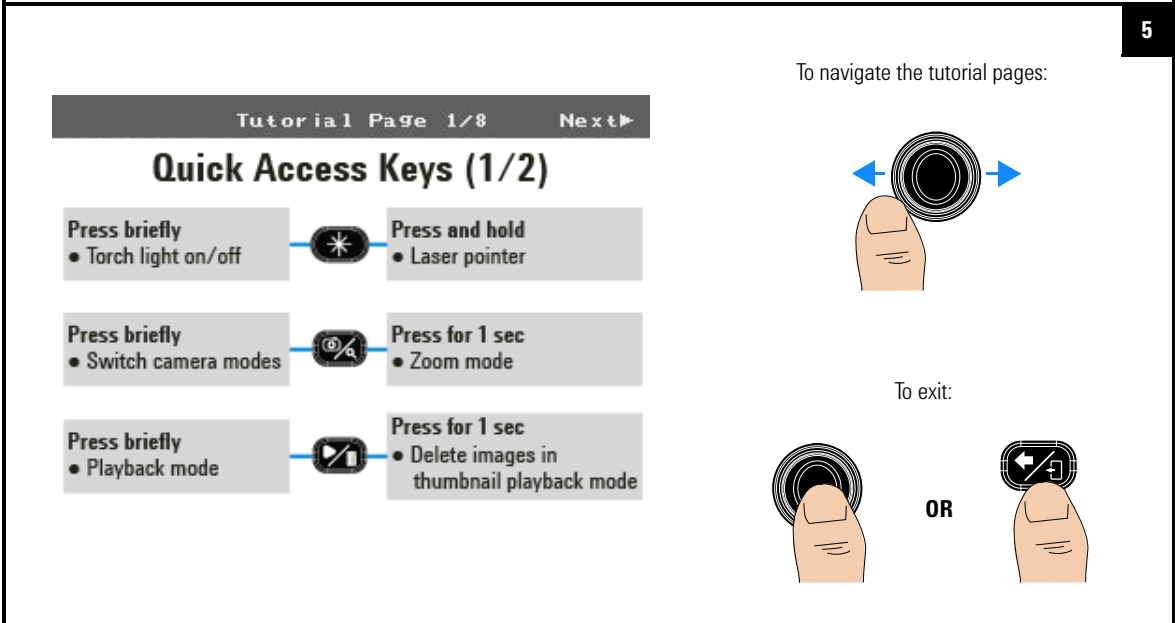
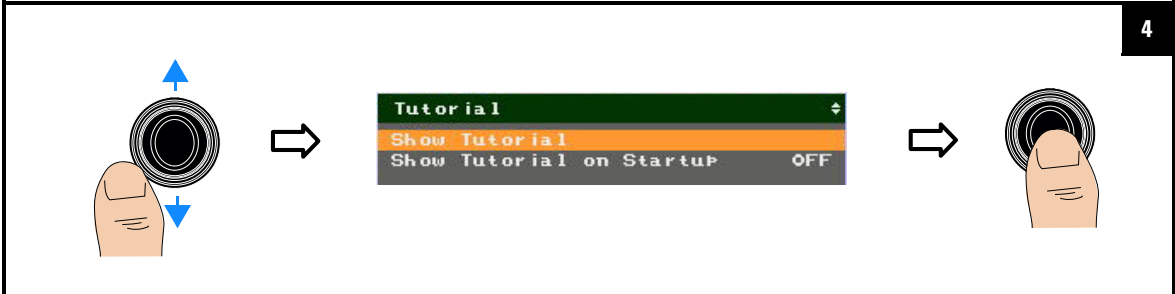
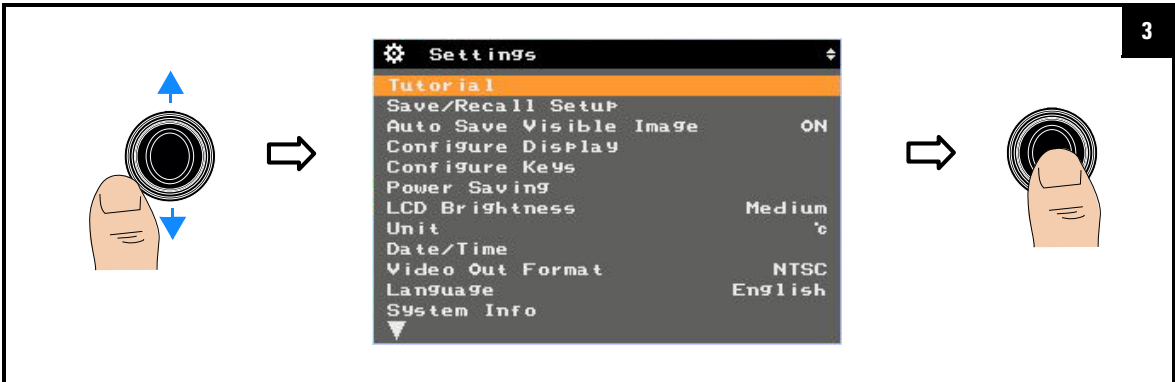

3 Data Management and System-Related Functions

System-Related Settings

To enable/disable the tutorial at power-on

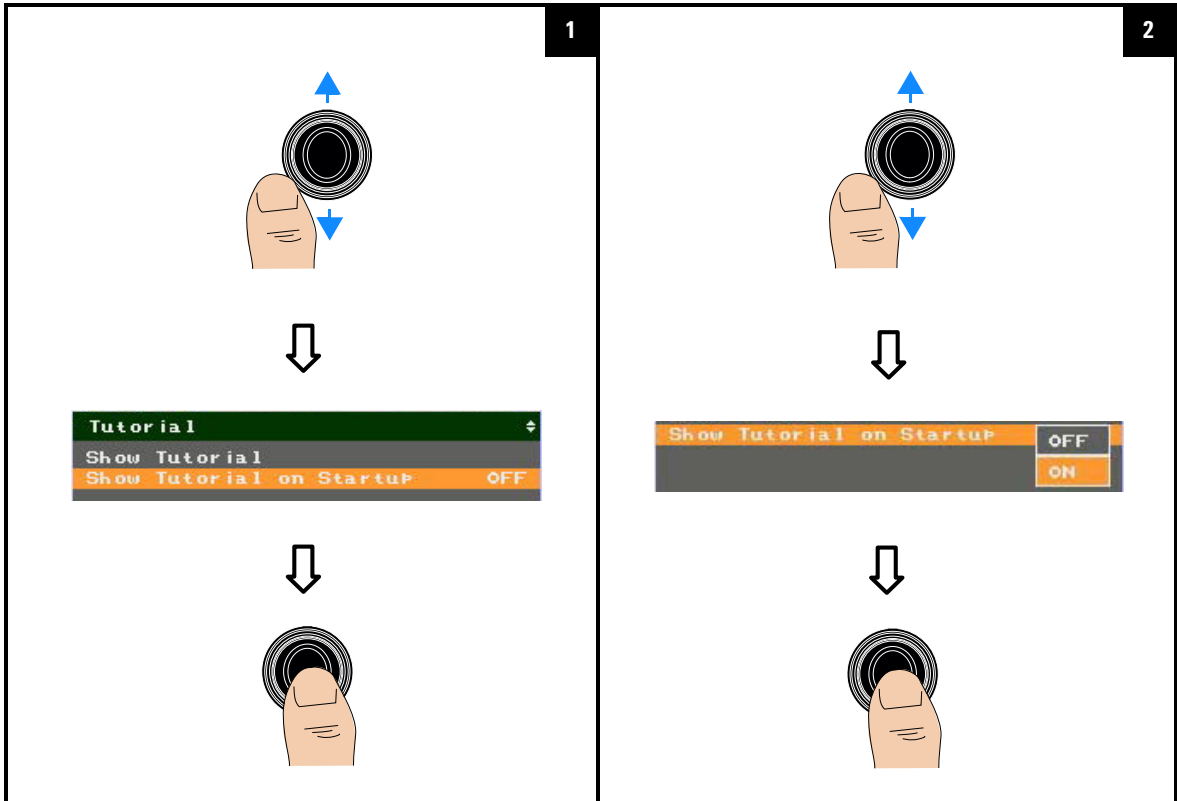

Save/recall instrument setups

You can save up to three instrument setups at a time into the SD memory card, and recall a setup to use. If there is an existing saved setup and you perform a save for the current setup, the existing setup will be overwritten.

NOTE

This function is not supported during image logging.

1

Follow steps 1 to 2 from ["To display the tutorial"](#) on page 84



2

Select **Save Setup** or **Recall Setup**:



3

Select a setup storage to save/recall:



3 Data Management and System-Related Functions

System-Related Settings

Turn on/off visible image auto-save

If you enable auto-save for visible images, both the IR and visible images will be saved. If disabled, only the IR image will be saved.

NOTE

This is only applicable for the IR camera mode. Visible images will always be auto saved in the Visible Camera, Picture in Picture, and Blend modes.

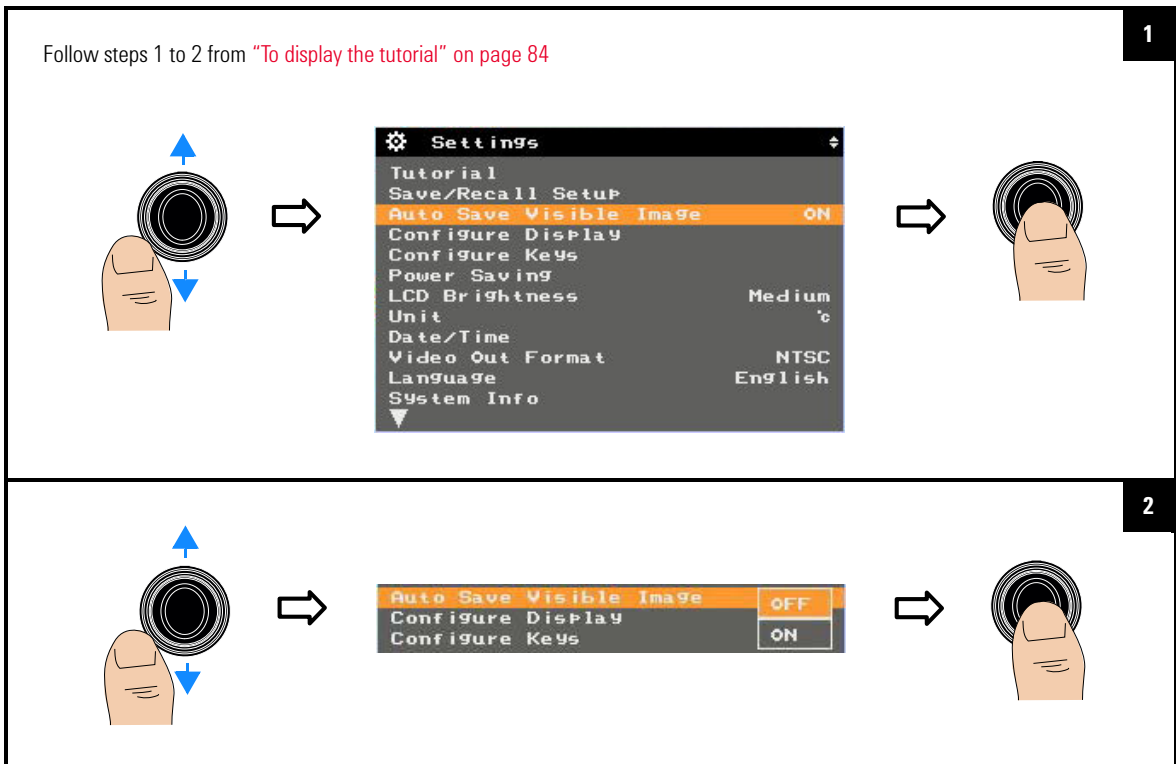

Configure the display items

You can set the items that you want to display on the screen.

Follow steps 1 to 2 from "To display the tutorial" on page 84

1

Settings	
Tutorial	
Save/Recall Setup	
Auto Save Visible Image	ON
Configure Display	
Configure Keys	
Power Saving	
LCD Brightness	Medium
Unit	°C
Date/Time	
Video Out Format	NTSC
Language	English
System Info	

2

Select **Date/Time**, **Color Bar**, or **Info Bar**:

Configure Display	
Date/Time	ON
Color Bar	ON
Info Bar	ON
Info Bar Items	

3

Date/Time	OFF
Color Bar	ON
Info Bar	ON

3 Data Management and System-Related Functions

System-Related Settings

4

To select the info bar items to display:

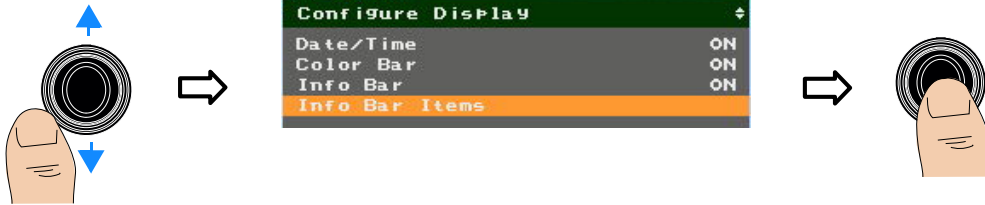

5

Select the items (only the first four items selected will be displayed):



To confirm and exit:



Configure the main key press functions

You can set the default functions for the Camera Trigger, Camera/Zoom, and Play/Delete key presses.

1

Follow steps 1 to 2 from "To display the tutorial" on page 84

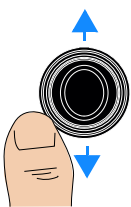

→

Settings	
Tutorial	
Save/Recall Setup	
Auto Save Visible Image	ON
Configure Display	
Configure Keys	
Power Saving	
LCD Brightness	Medium
Unit	'c
Date/Time	
Video Out Format	NTSC
Language	English
System Info	

→

2

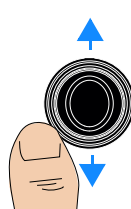
Select **Trigger/Camera/Playback**:



→

Configure Keys	
Trigger	Preview Only
Camera	
Playback	Thumbnail

→

3

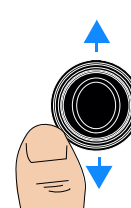
For example, if you select **Trigger**, you can set to preview and save the image, preview the image only, or save an image directly when you press the key:

→

Trigger	Preview/Save
Camera	Preview Only
Playback	Direct Save

→

3 Data Management and System-Related Functions

System-Related Settings

Set the power saving mode

You can enable/disable auto sleep or auto power-off, and change the timer period of these functions.

NOTE

- Auto sleep and auto power-off functions are disabled during image logging.
- Auto-power off functions are disabled in the image playback mode.

Follow steps 1 to 2 from "To display the tutorial" on page 84

1

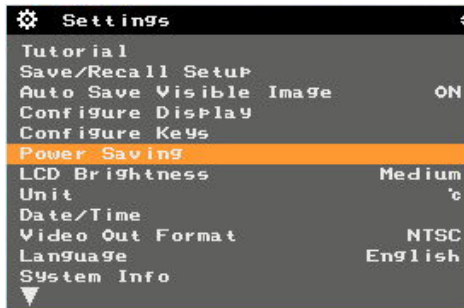
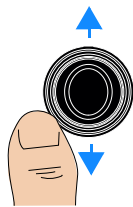

Select **Auto Sleep** or **Auto Off**:

2

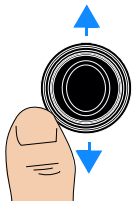
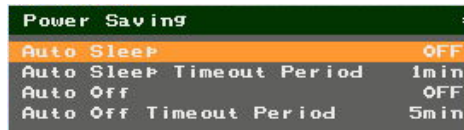
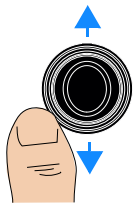

3

4

To set the auto sleep or auto power-off timer, select **Auto Sleep Timeout Period** or **Auto Off Timeout Period**:

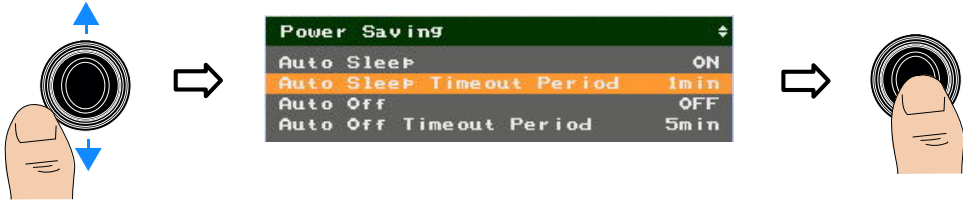

5

- Auto Sleep: **1 to 15 mins** (10 mins by default)
- Auto Off: **5 to 60 mins** (20 mins by default)



Push left/right to move the indicator.

Push up/down to increase/decrease the digits.

3 Data Management and System-Related Functions

System-Related Settings

Set the LCD brightness

If viewing the display becomes difficult in certain conditions, you can adjust the LCD brightness to high, medium, or low.

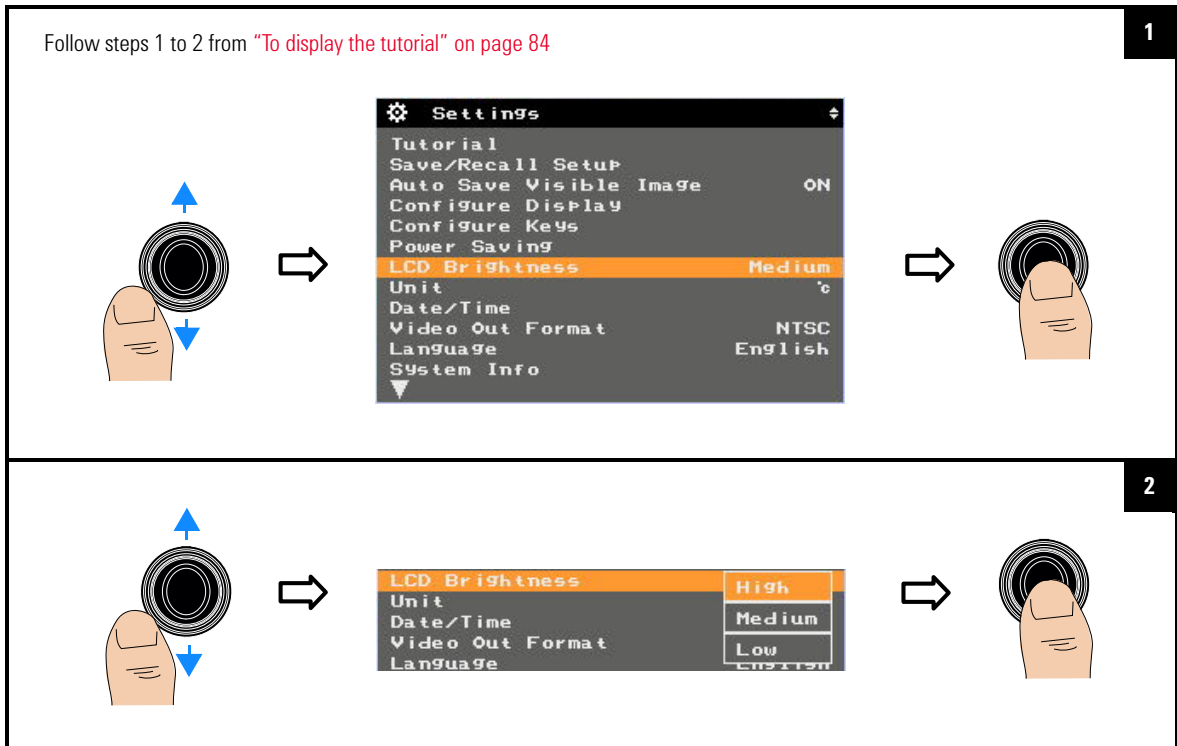

Set the temperature unit (°C or °F)

Refer to "Set up the U5855A" on page 9.

Set the date and time

Refer to "Set up the U5855A" on page 9.

Set the video out format

You can set the video out format to NTSC or PAL when you connect the U5855A to an external monitor.

NOTE

- The PAL and NTSC formats are full resolution screen videos. Hence, if a TV/projector/monitor screen is truncated, switch its OVERSCAN function to OFF.
- Video out is disabled in the power-saving mode.

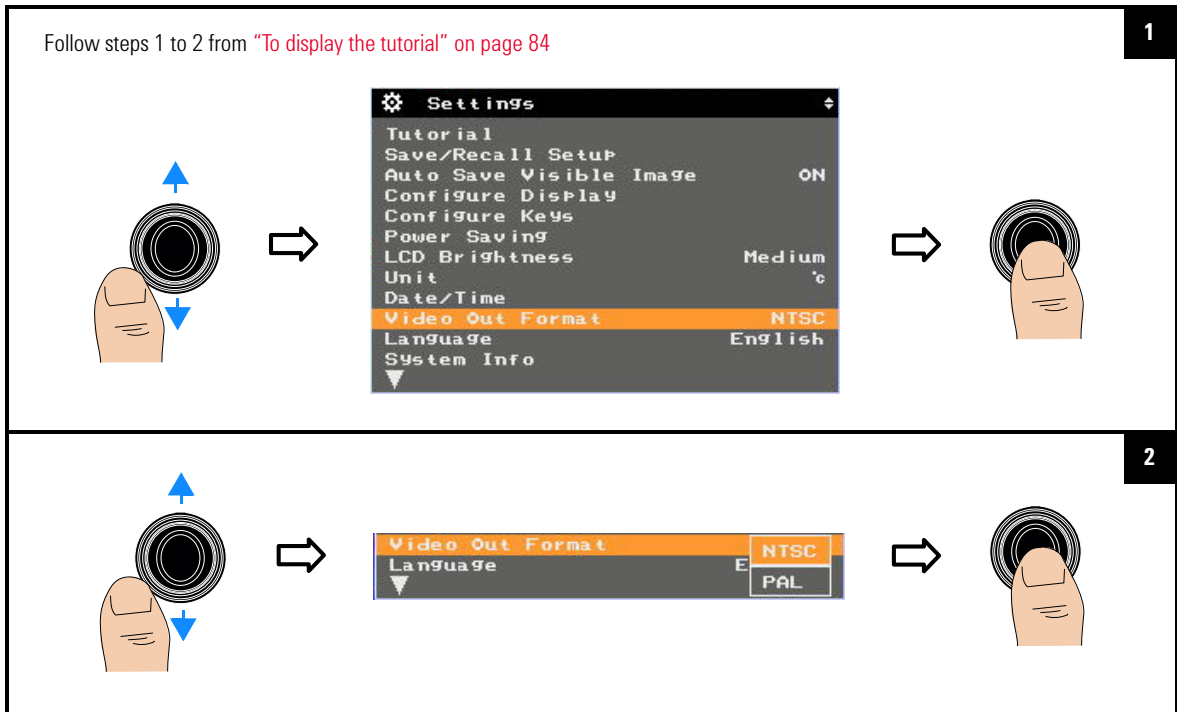

Set the language

Refer to "Set up the U5855A" on page 9.

3 Data Management and System-Related Functions

System-Related Settings

Display the system and owner information

To display the system information

Follow steps 1 to 2 from "To display the tutorial" on page 84

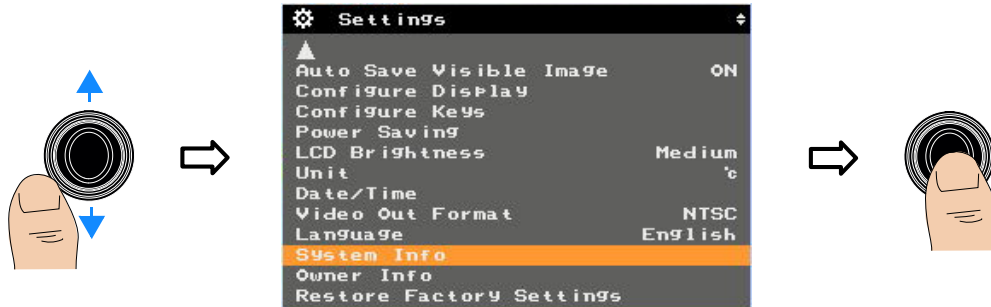

To display the owner information

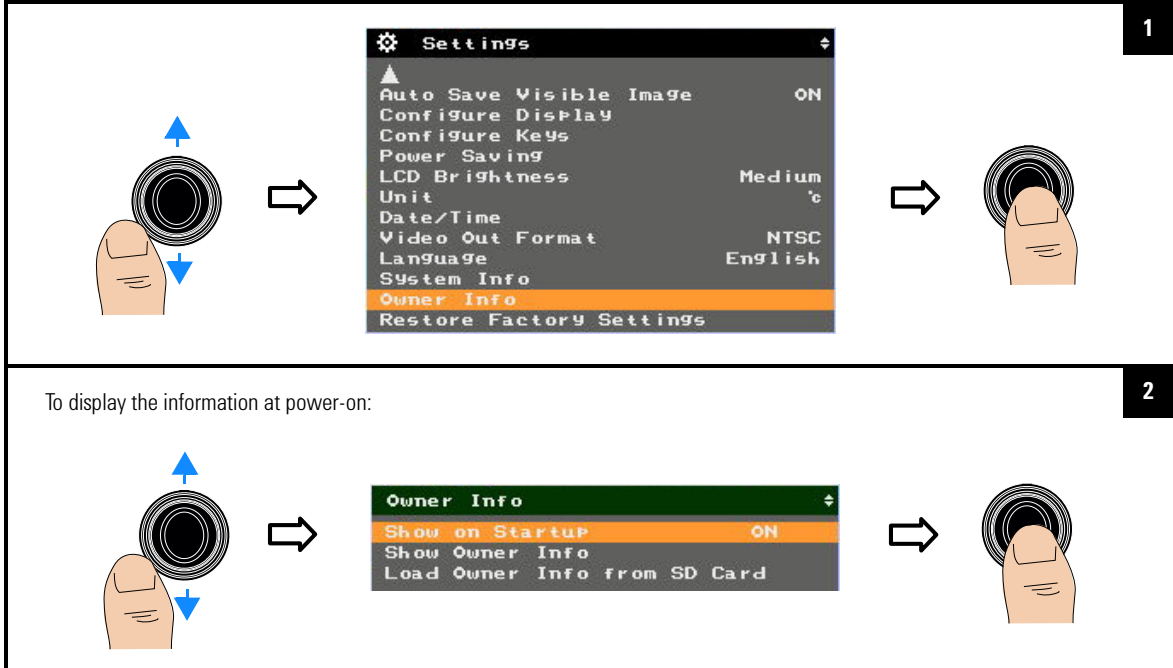

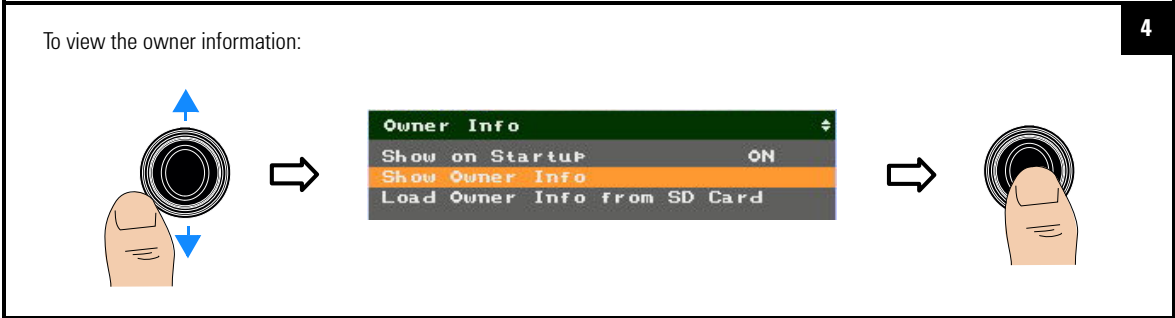

To add the owner information from a template file

You can download the owner information template file from the Keysight Web site to the SD memory card.

To ensure proper use of this template file, use the following guidelines:

- File name and extension: OWNERINF.TXT
- File format: Text file/Notepad
- File location: Root of the SD card
- Character code: ASCII (20h to 7Fh)
- Maximum line: 8 lines
- Maximum characters per line: 18 characters

When you load the owner information from the template file, the contents of the file are read and registered with the U5855A memory.

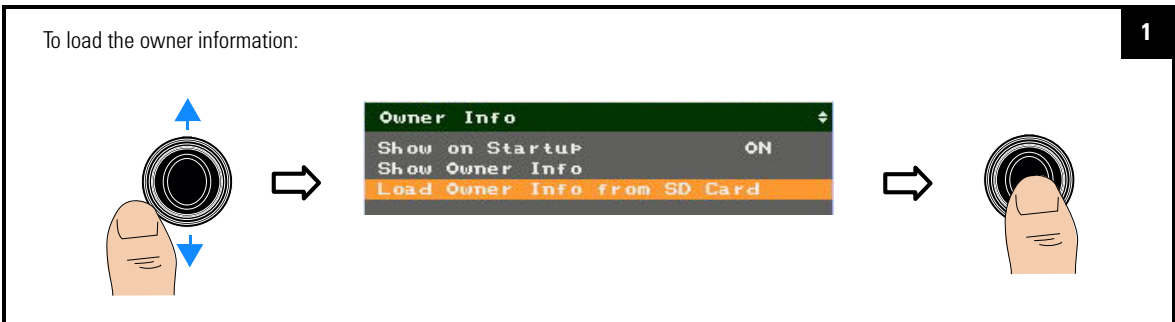

3 Data Management and System-Related Functions

System-Related Settings

Select **YES** to load the info file and return to the Owner Info menu:

2

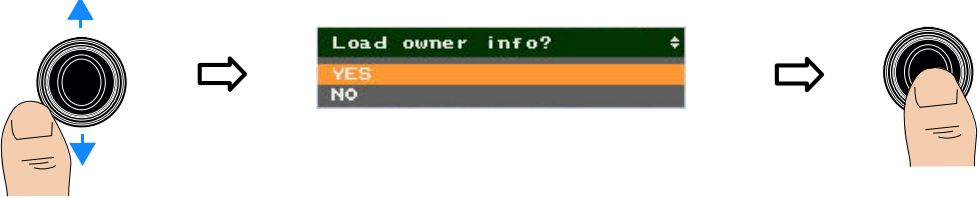

If the info file does not exist on the SD card, an error message is displayed

Reset the U5855A to factory default settings

Follow steps 1 to 2 from ["To display the tutorial"](#) on page 84

1

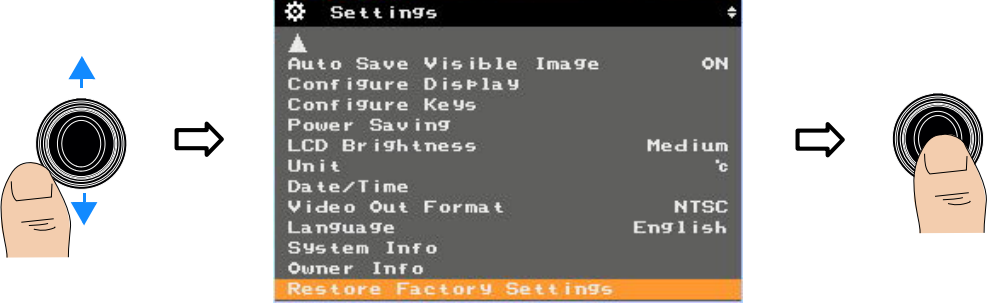

2

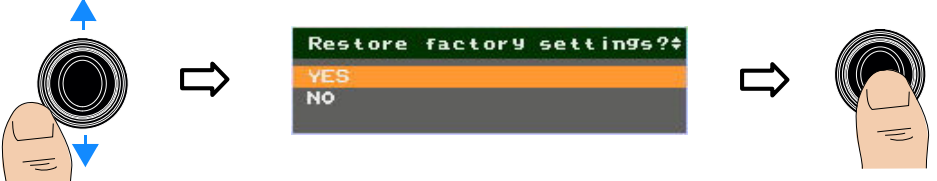

4

Characteristics and Specifications

Product Characteristics 100

Specifications 102

This chapter specifies the characteristics and specifications of the U5855A.

Product Characteristics

POWER SUPPLY

Power adapter:

- Line voltage range: 50/60 Hz, 100 – 240 VAC (Auto/Universal voltage), 1.2 A
- MAINS supply voltage fluctuations not to exceed $\pm 10\%$ of the nominal voltage
- Output voltage: 12 VDC, 3 A
- Installation Category I (Isolated ELV supply source — connected to MAINS through an AC/DC power adapter)

Battery:

- Li-Ion rechargeable battery, 7.4 VDC, 2500 mAh
- Operating time: 4 hours

DISPLAY

3.5" TFT

VISIBLE CAMERA

3.1 MP

BUILT-IN LED TORCH

Available

LASER POINTER

Class 2

WARM-UP TIME

2 minutes

OPERATING ENVIRONMENT

Refer to [“Environmental Conditions” on page VII](#)

STORAGE COMPLIANCE

Refer to [“Environmental Conditions” on page VII](#)

SAFETY AND EMC COMPLIANCE

Refer to [“Regulatory Information” on page VII](#)

SHOCK

Tested to IEC 60068-2-27 Ed. 3.0

VIBRATION

Tested to IEC 60068-2-6

DROP TEST

2 m

PROTECTION CLASS

2

IP RATING

IP54

DIMENSIONS (W × H × D)

95 × 250 × 85 mm

WEIGHT

0.746 kg (with battery)

CALIBRATION CYCLE

1 year

4 Characteristics and Specifications

Specifications

Specifications

Specifications are warranted in the temperature range of 0 to 40 °C and after 2 minutes of power up, unless otherwise noted.

Supplemental characteristics – which are not warranted, but are descriptions of performance – are determined either by design or testing.

Performance specifications

Parameter	Specification
BASIC PERFORMANCE	
Temperature measurement range	–20 ~ 350 °C Range 1: –20 to 120 °C Range 2: 0 to 350 °C
Thermal sensitivity	Range 1: 0.07 °C (at 30 °C) Range 2: 0.1 °C (at 30 °C)
Accuracy^[1] At 0 ~ 40 °C ambient temperature	±2 °C or ±2% (whichever is greater)
Detector type	Uncooled Focal Plane Array (α -Si)
Detector resolution	160 × 120
Fine resolution	320 × 240 (IR pixels)
Spectral range	8 to 14 μ m
Frame rate	9 Hz
Field of view (FOV)	28° (H) × 21° (V)
Spatial resolution (IFOV)	Fine resolution OFF: 3.1 mrad Fine resolution ON: 2.1 mrad
Focal distance	10 cm to infinity
Focus mechanism	Manual focus

Parameter	Specification
IMAGE PROCESSING	
Correction parameters	Emissivity, reflected temperature, object distance, ambient temperature, humidity, transmissivity
Emissivity correction	0.1 to 1.0 Predefined emissivity table
Digital zoom	Zoom ratio: 4× continuous
Color palette	Rainbow, iris, hot iron, gray, inverted gray
Camera mode	IR image, visible image, picture in picture, blend
MEASUREMENTS AND ALARM	
Measurements	Center spot, 3× moveable spots, max/min tracking, delta temperature, 3× moveable boxes (with min/max/avg)
Color alarm	High/low temperature in all areas Alarm zones: Above/below/inside/outside

[1] Minimum distance with accuracy, 10 cm to 50 cm: $\pm 4\text{ }^{\circ}\text{C}$ or $\pm 4\%$

4 Characteristics and Specifications

Specifications

Laser specifications

Parameter	Specification
Class	Class 2 (1 mW maximum)
Wavelength	655 nm (red)
Output	0.7 mW (CW)
Laser beam spot shape	Ellipse
Laser beam spot size	15 mm or less at 10 m
Beam divergence angle	1.2 mrad

Supplemental characteristics

Parameter	Characteristic
Storage device	Supports up to 32 GB SDHC memory card with class 4 and above
Image format	IR image: Radiometric JPEG Visible image: JPEG
State storage memory	Three user-configurable stored states
Tagging/annotation	3 photo tags, note tag, note tag from template (downloadable from the Keysight Web site)
I/O	USB 2.0 mass storage NTSC/PAL via video RCA cable
Language	English, French, German, Italian, Japanese, Korean, Portuguese, Russian, Spanish, Simplified Chinese, Traditional Chinese
Built-in quick start tutorial	Available
Optional accessories	<ul style="list-style-type: none"> • AC power adapter with power cord (U5751A) • Rechargeable Li-Ion battery (U5752A) • External battery charger, 2-bay (U5753A) • Video RCA to RCA interface cable, 2 m (U5761A) • USB Standard-A to Mini Type-B interface cable, 1 m (U5762A) • Rugged hard carrying case (U5771A) • Hand strap, adjustable for right-handed and left-handed use (U5772A)

4 Characteristics and Specifications

Specifications

THIS PAGE HAS BEEN INTENTIONALLY LEFT BLANK.

This information is subject to change without notice.
© Keysight Technologies 2014
Edition 2, August 2014

