

High Power Electronic Load

PEL-5000G Series

USER MANUAL



ISO-9001 CERTIFIED MANUFACTURER

GW INSTEK

This manual contains proprietary information, which is protected by copyright. All rights are reserved. No part of this manual may be photocopied, reproduced or translated to another language without prior written consent of Good Will company.

The information in this manual was correct at the time of printing. However, Good Will continues to improve products and reserves the rights to change specification, equipment, and maintenance procedures at any time without notice.

Good Will Instrument Co., Ltd.

No. 7-1, Jhongsing Rd., Tucheng Dist., New Taipei City 236, Taiwan.

Table of Contents

SAFETY INSTRUCTIONS	4
GETTING STARTED	8
PEL-5000G Series Introduction	9
Accessories	14
Operating Mode Description	16
Operating Area	22
Appearance	26
FUNCTION DESCRIPTION	36
Function keys description	37
Test keys description	54
System and Memory keys description	76
Auto Sequence keys description	81
Entry description	85
CONNECTION	87
Rear Panel	88
Connecting the I-monitor to an oscilloscope	92
Master/Slave Instructions	93
INSTALLATION	97
Check line voltage	98
Grounding requirements	98
Power up	99
Connection to the load input terminal	99
Interface Option	100
I/O connection	104
Load current slew rate setting	105
Load wire inductance	107

REMOTE CONTROL	111
Configure RS232C	112
Communication Interface programming comm and list	114
Command Syntax	127
Command List	129
Preset Commands	132
Limit Commands	147
State Commands.....	150
System Commands	156
Measure Commands	158
Auto Sequence Commands	159
APPLICATION	162
Local sense connections	164
Remote sense connections	165
Constant Current mode application	166
Constant Voltage mode application.....	169
Constant Resistance mode application	171
Constant Power mode application.....	173
Applications with current limiting or power limiting function CV mode operation (charging device)	175
CV + Current Limit mode of operation application	177
CV + Power Limit mode of operation application	179
Constant current source operating.....	181
Zero-Volt loading application	182
Parallel operation	183
Power Supply OCP testing	184
Power Supply OPP testing	186
SHORT testing.....	188
Battery discharge test	190
Abnormal testing of power supply	192
BMS Protective device	195
Model 9923 current waveform generator.....	204

SEQUENCE LOAD (remote only)	213
APPENDIX	216
PEL-5000G Default Settings	217
Replacing the Fuse	220
PEL-5000G Dimensions	221
Terminal Dimensions	222
PEL-5000G series Specifications	223
Certificate Of Compliance	240
GPIB programming Example	241
PEL-5000G series USB Instruction	245
PEL-5000G series LAN Instruction	247
PEL-5000G series Auto-Sequence function provide EDIT, ENTER, EXIT, TEST and STORE 5 keys operation	250

S SAFETY INSTRUCTIONS

This chapter contains important safety instructions that you must follow during operation and storage. Read the following before any operation to insure your safety and to keep the instrument in the best possible condition.

Safety Symbols

These safety symbols may appear in this manual or on the instrument.



WARNING

Warning: Identifies conditions or practices that could result in injury or loss of life.



CAUTION

Caution: Identifies conditions or practices that could result in damage to the instrument or to other properties.



DANGER High Voltage



Attention Refer to the Manual



Earth (ground) Terminal



Frame or Chassis Terminal



Do not dispose electronic equipment as unsorted municipal waste. Please use a separate collection facility or contact the supplier from which this instrument was purchased.

Safety Guidelines

General Guideline



CAUTION

- Do not place any heavy object on the instrument. Note: Only 2 units can be stacked vertically.
- Avoid severe impact or rough handling that leads to damaging the instrument.
- Do not discharge static electricity to the instrument.
- Use only crimped wires, not bare wires, for the terminals.
- Do not block the cooling fan opening.
- Do not disassemble the instrument unless you are qualified.
- The equipment is not for measurements performed for CAT II, III and IV.

(Measurement categories) EN 61010-1:2010 specifies the measurement categories and their requirements as follows.

- Measurement category IV is for measurement performed at the source of low-voltage installation.
- Measurement category III is for measurement performed in the building installation.
- Measurement category II is for measurement performed on the circuits directly connected to the low voltage installation.
- 0 is for measurements performed on circuits not directly connected to Mains.

-
- Do NOT position the equipment so that it is difficult to disconnect the appliance inlet or the power plug.
 - If the equipment is used in a manner not specified by the manufacturer, the protection provided by the equipment may be impaired.
-

Power Supply	<ul style="list-style-type: none">• AC Input voltage range: 100-240VAC, Single phase 90-250VAC
 WARNING	<ul style="list-style-type: none">• Frequency: 47-63Hz• To avoid electrical shock connect the protective grounding conductor of the AC power cord to an earth ground.• To avoid electric shock, the power cord protective grounding conductor must be connected to ground. No operator serviceable components inside. Do not remove covers. Refer servicing to qualified personnel.
Cleaning	<ul style="list-style-type: none">• Disconnect the power cord before cleaning.• Use a soft cloth dampened in a solution of mild detergent and water. Do not spray any liquid.• Do not use chemicals containing harsh material such as benzene, toluene, xylene, and acetone.
Operation Environment	<ul style="list-style-type: none">• Location: Indoor, no direct sunlight, dust free, almost non-conductive pollution (Note below)• Temperature: 0°C to 40°C• Humidity: 0 to 85% RH• Altitude: <2000m• Overvoltage category II

(Pollution Degree) EN 61010-1:2010 specifies the pollution degrees and their requirements as follows. The instrument falls under degree 2.

Pollution refers to “addition of foreign matter, solid, liquid, or gaseous (ionized gases), that may produce a reduction of dielectric strength or surface resistivity”.

- Pollution degree 1: No pollution or only dry, non-conductive pollution occurs. The pollution has no influence.
- Pollution degree 2: Normally only non-conductive pollution occurs. Occasionally, however, a temporary conductivity caused by condensation must be expected.
- Pollution degree 3: Conductive pollution occurs, or dry, non-conductive pollution occurs which becomes conductive due to condensation which is expected. In such conditions, equipment is normally protected against exposure to direct sunlight, precipitation, and full wind pressure, but neither temperature nor humidity is controlled.

Storage environment

- Location: Indoor
- Temperature: -20°C to 70°C
- Humidity: <90% RH

Disposal



Do not dispose this instrument as unsorted municipal waste. Please use a separate collection facility or contact the supplier from which this instrument was purchased. Please make sure discarded electrical waste is properly recycled to reduce environmental impact.

GETTING STARTED

The PEL-5000G series Electronic Load is designed to test, evaluation and burn-in of DC power supplies and batteries.



PEL-5000G Series Introduction	9
Model Line Up.....	9
Main Features.....	10
Protection features	11
Accessories	14
Operating Mode Description	16
CC Mode.....	16
CR mode	16
CV mode.....	17
CP mode	17
Slew Rate.....	17
Dynamic Waveform Definition	20
Operating Area	22
Appearance	26
Front Panel.....	26
LCD Display	27

PEL-5000G Series Introduction

Model Line Up

Normal mode

Model	Voltage	Current	Power
PEL-5004G-150-400	150V	400A	4000W
PEL-5005G-150-500	150V	500A	5000W
PEL-5006G-150-600	150V	600A	6000W
PEL-5004G-600-280	600V	280A	4000W
PEL-5005G-600-350	600V	350A	5000W
PEL-5006G-600-420	600V	420A	6000W
PEL-5004G-1200-160	1200V	160A	4000W
PEL-5005G-1200-200	1200V	200A	5000W
PEL-5006G-1200-240	1200V	240A	6000W

Turbo mode

Model	Voltage	Current	Power
PEL-5004G-150-400	150V	600A	6000W
PEL-5005G-150-500	150V	750A	7500W
PEL-5006G-150-600	150V	900A	9000W
PEL-5004G-600-280	600V	420A	6000W
PEL-5005G-600-350	600V	525A	7500W
PEL-5006G-600-420	600V	630A	9000W
PEL-5004G-1200-160	1200V	240A	6000W
PEL-5005G-1200-350	1200V	300A	7500W
PEL-5006G-1200-240	1200V	360A	9000W

Main Features

- Features
- 5 digital V/A/W Meter can be displayed on Large LCD display simultaneously.
 - Flexible CC, CR, CV, CP, CC + CV, CP + CV, Dynamic and short circuit operation modes.
 - Not only CC, CR, and CP mode have parallel operation functions, but CV mode also has parallel operation functions.
 - Can set the power-on status value.
 - Short circuit duration can be set within short circuit test.
 - Voltage meter display can be configured as polarity positive (“+”) or negative (“-”).
 - Master-slave control is up to 1 Master and 7 Slaves.
 - Optional Interface: GPIB, RS232, USB, LAN.
 - Support CC, CR, CV, CP test function for solar panel.
 - Provide battery BMS protection test function.
 - Optional 9923 load current waveform generator to provide the battery actual discharge current waveform simulation.
 - Built-in test modes include Battery Discharge, BMS, Short circuit, OCP, OPP test modes.
 - Turbo mode can withstand up to 1.5 times the current and power electronic load within 2 sec. period, most fit BMS, Short circuit, OCP, OPP test.
 - Protection against V, I, W, and °C

Protection features

The protection features of the PEL-5000G series Electronic load modules are as follows:

Overvoltage protection	<p>The Electronic Load will turn OFF Load OFF if the overvoltage circuit is tripped. The message OVP will be displayed on the LCD. When the OVP fault has been removed the load can be set to sink power again. While the unit will attempt to protect itself given an OVP state it is strongly advised to guard against any potential OVP fault state by using external protection and the correctly rated electronic load.</p> <p>The Overvoltage protection circuit is set at a predetermined voltage and cannot be adjusted. The OVP level is 105% of the PEL-5004G-150-400, PEL-5005G-150-500, PEL-5006G-150-600, PEL-5004G-600-280, PEL-5005G-600-350, PEL-5006G-600-420 Series nominal voltage rating. The OVP level is 105% of the PEL-5004G-1200-160, PEL-5005G-1200-200, PEL-5006G-1200-240 nominal voltage rating.</p>
Caution	<p>Never apply an AC voltage to the input of the PEL-5000G series Load. Do not apply a DC voltage that is higher than PEL-5000G series Load rating. If this advice is ignored it is likely that damage will be caused to the electronic load module. This damage will not be covered by the warranty.</p>
Over current protection (OCP)	<p>The PEL-5000G series electronic load monitors the power dissipation level. The input to the load is automatically switched to LOAD OFF if the power dissipation is greater than 104% of the rated power input. If an over power condition occurs the display will show OCP.</p>

Over power protection (OPP) The PEL-5000G series Electronic Load monitors the power dissipation level. The input to the load is automatically switched to LOAD OFF if the power dissipation is greater than 105% of the rated power input. If an over power condition occurs the display will show OPP.

Over temperature protection The load internal temperature at the heat sink is monitored. If the temperature reaches approximately $90^{\circ}\text{C} \pm 5^{\circ}\text{C}$ the OTP message will be displayed and the unit will automatically switch to the LOAD OFF state. If an OTP error occurs please check the ambient temperature is between 0 to 40°C . Also ensure that the front and rear air vents of the mainframe are not obstructed. The air flow is taken from the front of the mainframe and exhausted from the rear. Therefore a suitable gap needs to be left at the rear of the mainframe. A minimum of 15cm is recommended. After a suitable cooling period the load can be switched.

Reverse Polarity The PEL-5000G series load module will tolerate a reverse current up to the maximum current rating of the load module. The "-" symbol will be shown on the voltage and current displays.



Note

Damage will occur if the reverse current is higher than the load module's maximum rating. If a reverse current is noticed turn off and disconnect the dc power source and turn the load off. The connections between the DC Source and the Load Module can now be correctly made.



If a reverse polarity situation occurs the load will sink power even if the LOAD button is OFF. No current will be displayed on the PEL-5000G series load module. Current up to the load's maximum current rating will be tolerated in reverse polarity. However there is no OVP OCP and OPP protection. It is strongly recommended that the load lines be fused if it is likely that the load could be subject to reverse polarity. These fuses should be fast acting and rated at the maximum current of the load module +5%.

Accessories

Standard Accessories	Description	PCs
PEL-5000G series operation manual	It can be downloaded from GW Instek website.	
SLS10B RED; PLUG CONN 20A RED T	Please refer to Fig. 2 on page 15. This terminal (SLS10B) is for Vsense.	1
SLS10B BLK; PLUG CONN 20A BLK T	Please refer to Fig. 2 on page 15. This terminal (SLS10B) is for Vsense.	1
PTV1-12 ; PIN TRML	Please refer to Fig. 1 on page 15.	4
HD-DSUB 15pin MALE to MALE 150cm		1
RND SCREW M4x0.7+S+P L=20mm		4
Hexagon head M8*1.25 L=25mm NI		2
K-NUT M4X0.7 NI		4
NUT M8X1.25 NI		2
WASHER INSIDE DIA-8.5 OUTSIDE		4
SPRING WASHER INSIDE ϕ 8		2
PEL-5004G, PEL-5005G, PEL-5006G handles	PEL-028	1
Rack Mount Kit For PEL-5004G, PEL-5005G, PEL-5006G	PEL-031	1
Optional Accessories	Description	PCs
GPIB+RS232 interface	PEL-030	1
RS232 interface	PEL-023	1
9923+RS232 interface	PEL-032	1

GPIB interface	PEL-022	1
USB interface + USB driver (The driver can be downloaded from GW Instek website)	PEL-025	1
LAN interface + LAN driver (The driver can be downloaded from GW Instek website)	PEL-024	1
GPIB cable	GTL-250 GPIB Cable, 1m	1
GPIB cable	GTL-248 GPIB Cable, 2m	1
USB cable	GTL-246 USB Cable, 1.2m	1

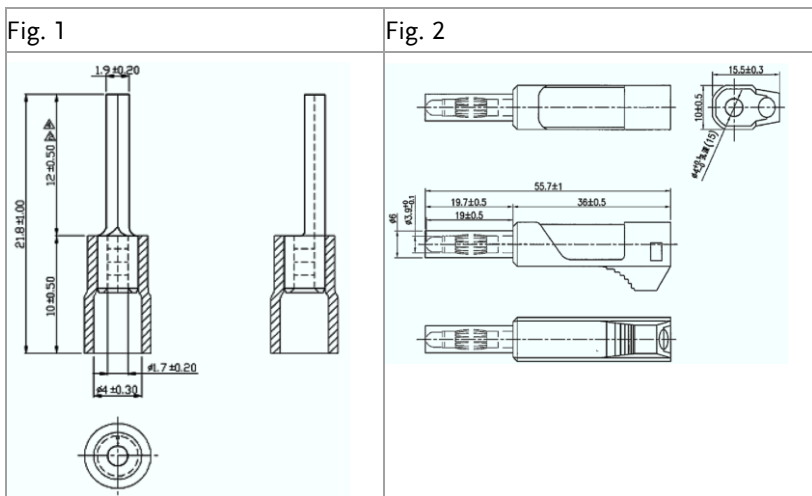

Operating Mode Description

CC Mode

Background

With the operating mode of Constant Current, the PEL-5000G series electronic load will sink a current in accordance with the programmed value regardless of the input voltage

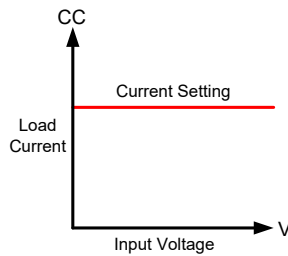

CR mode

Background

At Constant Resistance mode, the PEL-5000G series Electronic Load will sink a current linearly proportional to the load input voltage in accordance with the programmed resistance setting.

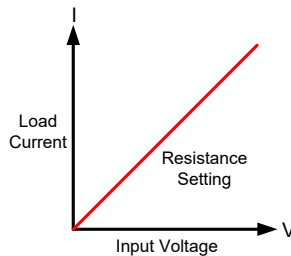

CV mode

Background

At Constant Voltage mode, the PEL-5000G series Electronic Load will attempt to sink enough current until the load input voltage reaches the programmed value.

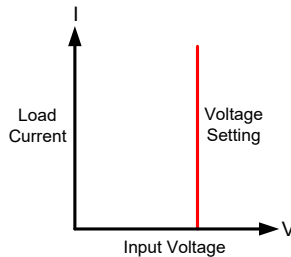

CP mode

Background

At Constant Power mode, the PEL-5000G series Electronic Load will attempt to sink load power (load voltage * load current) in accordance with the programmed power.

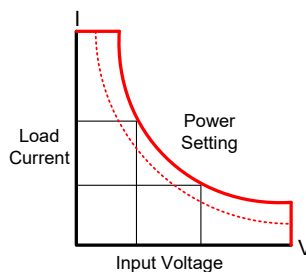

Slew Rate

Background

Slew rate is defined as the change in current or voltage over time. A programmable slew rate

allows for a controlled transition from one load setting to another. It can be used to minimize induced voltage drops on inductive power wiring, or to control induced transients on a test device (such as would occur during power supply transient response testing).

In cases where the transition from one setting to another is large, the actual transition time can be calculated by dividing the voltage or current transition by the slew rate. The actual transition time is defined as the time required for the input to change from 10% to 90% or from 90% to 10% of the programmed excursion.

In cases where the transition from one setting to another is small, the small signal bandwidth (of the load) limits the minimum transition time for all programmable slew rates. Because of this limitation, the actual transition time is longer than the expected time based on the slew rate, as shown in the picture below.

Rise Time Transition Limitation

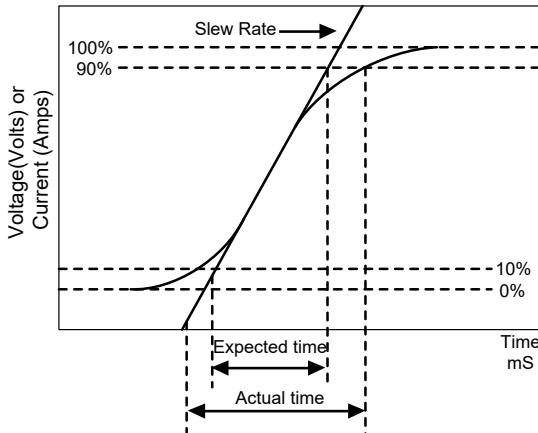

Therefore, both minimum transition time and slew rate must be considered when determining the actual transition time.

Following detail description is excluding in specification sheet.

The minimum transition time for a given slew rate as about a 30% or greater load change, The slew rate increases from the minimum transition time to the Maximum transition time at a 100% load change. The actual transition time will be either the minimum transition time, or the total slew time (transition divided by slew rate), whichever is longer.

Example

PEL-5006G-150-600
150V/600A/6000W (CCH - CCL >600A x 30%)

Use the following formula to calculate the minimum transition time for a given slew rate min transition time =

180A/slew rate (in amps/second).

$$7.5\mu\text{S} (180\text{A}/24) \times 0.8(10\% \sim 90\%) = 6\mu\text{S}$$

Use the following formula to calculate the maximum transition time for a given slew rate max transition time =

600A/slew rate (in amps/second).

$$25\mu\text{S} (6000\text{A}/24) \times 0.8(10\% \sim 90\%) = 20\mu\text{S}$$

Example

CCH=168A, CCL=0A, Slew Rate =24A

The expected time is 5.6 μS but the actual transition time will be limited to 4.8 μs .

$$7\mu\text{S} (168/24 \times 0.8(10\% \sim 90\%)) = 5.6\mu\text{S}$$



Note

When CC mode rang 1 slew rate, CCL setting at least 0.1% larger than the specification.

Dynamic Waveform Definition

Background

Along with static operation the PEL-5000G series Electronic Load are built with a Dynamic mode for operation in Constant Current (CC), Constant Resistance (CR) or Constant Power (CP). This allows the test engineer to simulate real world pulsing loads or implement a load profile that varies with time.

A dynamic waveform can be programmed from the front panel of the PEL-5000G series Electronic Load. The user would first set a High and low value of load current using the Level button. The Dynamic Setting then allows for the rise and fall time between these 2 current values to be adjusted. The time period that the waveform is high (Thigh) along with the time period that the waveform is low (Tlow) can also be set.

Dynamic Wave form

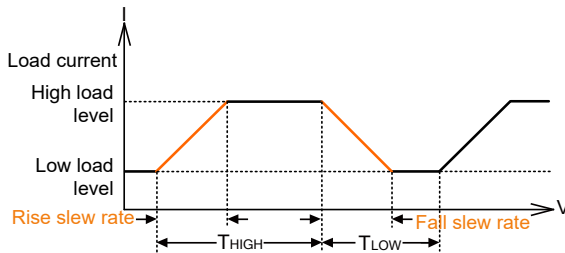

The dynamic waveform can also be set up via the optional computer interface. Dynamic waveform settings made from the front panel of the load module can also be saved in the memory of the PEL-5000G series Electronic Load. For the store/recall procedure and the computer command set please refer to the relevant operating manual for the PEL-5000G series Electronic Load.

Further dynamic waveform definitions are:

- The period of dynamic waveform is $T_{high} + T_{low}$
- The dynamic frequency = $1 / (T_{high} + T_{low})$
- The duty cycle = $T_{high} / (T_{high} + T_{low})$

Example 1

PEL-5000G series, Dynamic up to 50 kHz frequency

Dynamic highest frequency 50 kHz = 0.02ms=20us

Setting THIGH=10 uS, TLOW=10uS,

THIGH+TLOW=20uS

CCH-CCL/SR \leq 10uS

Setting CCH=30A, CCL=10A

$(30-10)/2.5A/uS \leq 10 uS$

8 uS \leq 10 uS ,Compliance with frequency 50kHz

Example 2

Setting THIGH=10 uS, TLOW=10uS,

THIGH+TLOW=20uS

CCH-CCL/SR \leq 10uS

Setting CCH=50A, CCL=0A

$(50-0)/2.5A/uS=20uS$, $20uS > 10uS$, It's not compliance the frequency 50 kHz

The analogue programming input also provides a convenient method of implementing a dynamic waveform. Please see the paragraph titled "Analog Programming Input" on page 90 for further information.

Operating Area

The PEL-5000G series electronic load can be operated for manual and GPIB operation. The power contour of PEL-5000G series Electronic Load is shown in figures below.

The GW INSTEK PEL-5000G series high power electronic Load can be controlled locally at the front panel or remotely via computer over the GPIB/RS232/USB/LAN. Constant Current (CC) mode, Constant Resistance (CR) mode, and Constant Voltage (CV) mode, and Constant Power (CP) mode. The wide range dynamic load with independent rise and fall current slew rate and analog programming input with arbitrary wave-form input is available in Constant Current mode.

PEL-5004G-150-400
power contour

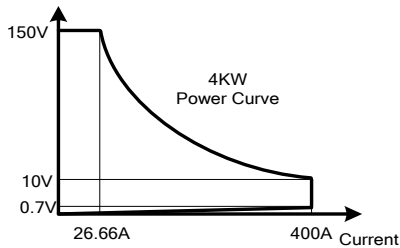

PEL-5005G-150-500
power contour

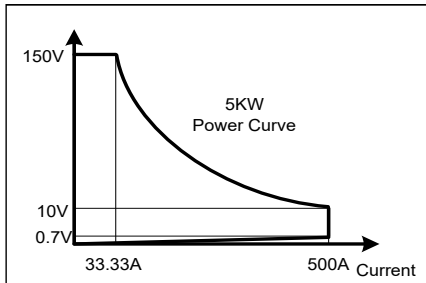

PEL-5006G-150-600
power contour

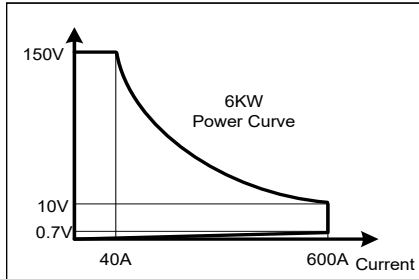

PEL-5004G-150-400
PEL-5005G-150-500
PEL-5006G-150-600
power rating

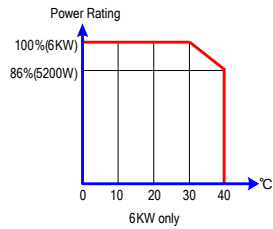
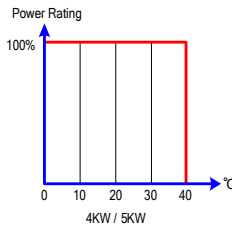

PEL-5004G-600-280
power contour

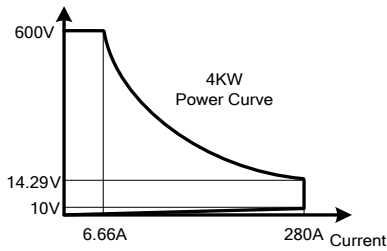

PEL-5005G-600-350
power contour

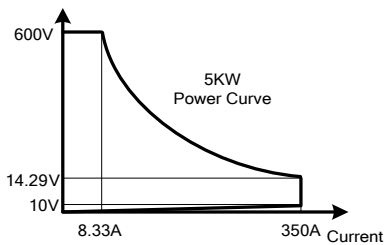

PEL-5006G-600-420
power contour

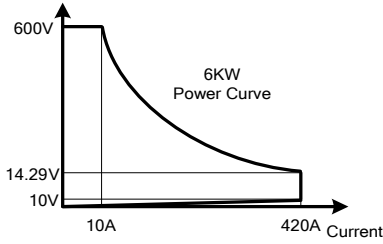

PEL-5004G-600-280
PEL-5005G-600-350
PEL-5006G-600-420
power rating

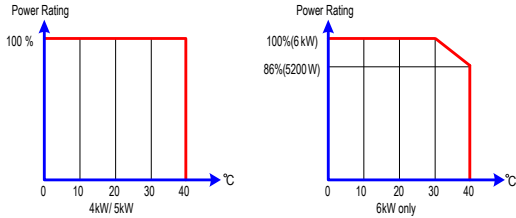

PEL-5004G-1200-160
power contour

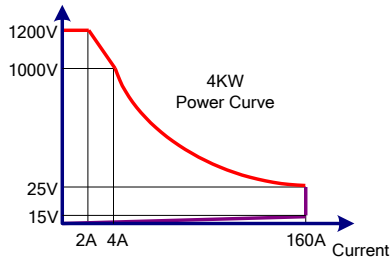

PEL-5005G-1200-200
power contour

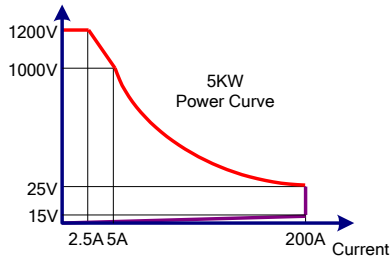

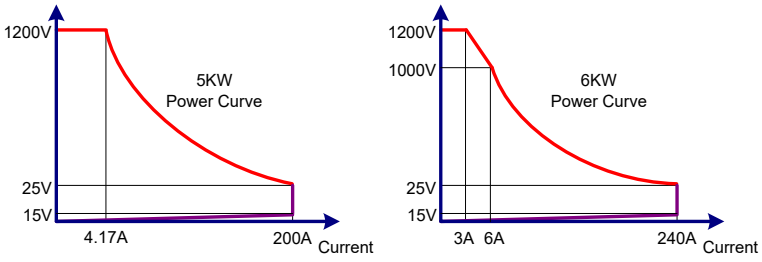

PEL-5004G-1200-160
 PEL-5005G-1200-200
 PEL-5006G-1200-240
 power rating

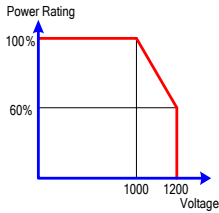
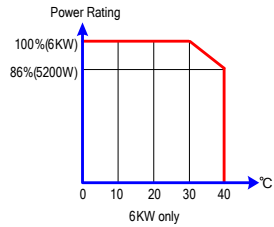
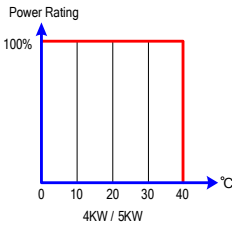

Appearance

Front Panel

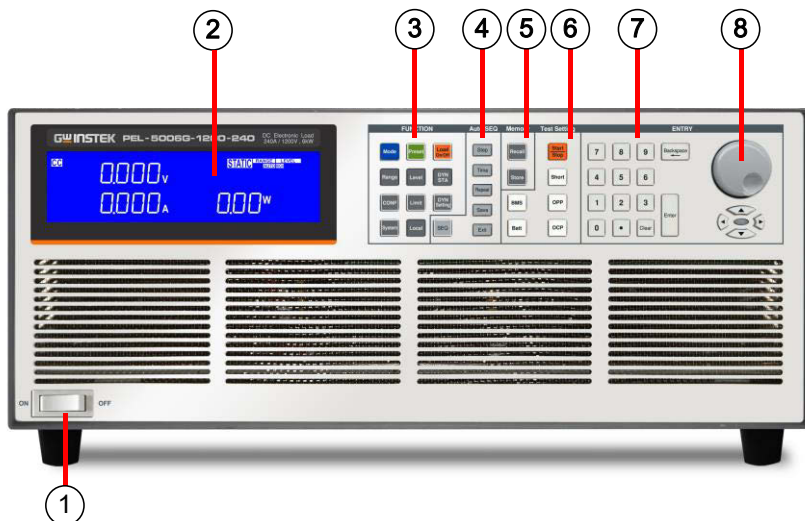

- 1 Power switch
- 2 LCD Multi-function display
- 3 Function keys
- 4 Auto sequence keys
- 5 Memory keys
- 6 Test function keys
- 7 Number keypad
- 8 Knob setting

LCD Display

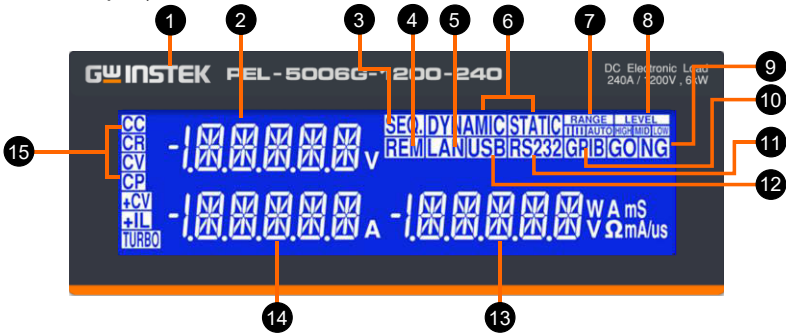

1 Model number and sink ranges	The model number along with maximum voltage, current and power values are detailed in this position at the top of the load front panel.
2 Left 5 digit LCD display	<p>The 5 digit LCD display is a multi-function display. The function of the display changes depending whether the user is in NORMAL mode or in a SHORT, OPP or OCP modes.</p> <p>Status display: When enter system setting or auto sequence mode, it displays setting status.</p> <p>Normal mode The left 5 digit display displays the voltage present at the load’s input terminals. The value displayed will include the automatic voltage compensation if the sense. Terminals are also connected to the device under test (DUT).</p>
! Note	<p>If V-sense is set to “AUTO” and the sense leads are connected to the DUT the losses need to be approx.700mV (PEL-5004G-150-400, PEL-5005G-150-500, PEL-5006G-150-600), the DUT the losses need to be approx.10V (PEL-5004G-600-280, PEL-5005G-600-350, PEL-5006G-600-420), the DUT the losses need to be approx.15V (PEL-5004G-1200-160, PEL-5005G-1200-200G, PEL-5006G-1200-</p>

	<p>240G) before the Display Compensates for the Voltage loss.</p> <p>If V-sense is set to “ON” and the sense terminals are connected to the DUT the load will check and compensate for all voltage drops.</p>
Test mode	<p>If the SHORT, OPP or OCP buttons are pressed the left display will show a text Message that correlates with the selected test function.</p> <ul style="list-style-type: none">• SHORT test selected: left display will show “Short”.• OPP test selected: left display will show “OPP”.• OCP test selected: left display will show “OCP”. <p>During the test the left display will show the load Input voltage.</p>
3 SEQ. indicator	<p>When entering AUTO SEQUENCE mode, LCD indicator will light up.</p>
4 REM LCD Indicator	<p>If the REMOTE LCD Indicator is illuminated this means that the unit is operating remotely via one of the optional interfaces. While REMOTE is lit it is not possible to make settings manually at the front panel. The LOCAL button on the mainframe can be used to revert back to front panel control. When the unit is operating from the front panel the REMOTE LCD will not be illuminated.</p>
5 LAN mode Lit	<p>It is LAN interface inside.</p>
7 Rang LED Indicator	<p>The PEL-5000G series Load Module features 2 setting ranges for CC, CR, CV & CP operation. This allows improved resolution for setting low values. When left in the default AUTO mode the changeover between ranges is automatic depending on the setting value entered.</p>

If desired the RANGE button can be pressed to force the unit to operate only in RANGE II. This is signaled by the accompanying LED becoming lit.



Note

That it is only possible to force RANGE II in CC mode.

8 Level LED Indicator

The LEVEL button is used to program a High or Low load value. The setting value changes between current, resistance, voltage or power depending whether CC, CR, CV or CP mode has been selected. If the LED is lit then the High level value setting has been enabled. If the LED is not lit then the low load level can be set using the rotary switch in combination with the arrow keys.

In STATIC mode the user can switch between High and low load levels during operation.

In DYNAMIC operation (CC & CP modes only) the preset high and low levels are used to define the dynamic waveform.



Note

The low level setting cannot exceed the high level. The converse is also true in that the High level cannot be set below the low level.

9 NG LCD Indicator

The user can adjust upper and lower limits for voltage, current and power within the CONFIG menu and turn the NG Indicator ON. If a voltmeter, ammeter or wattmeter measurement is outside these set limits then the NG indicator will illuminate.

10 GPIB mode indicator

If PEL-5000G series is controlled by GPIB through PC, the GPIB will be lit.

11 RS232 mode indicator

If PEL-5000G series is controlled by RS232 through PC, the RS232 will be lit.

12 USB mode indicator

If PEL-5000G series is controlled by USB through PC, the USB will be lit.

13 The right 5 digit displays	<p>The right 5 digit displays also changes function depending if the unit is in normal mode or one of the setting menus has been activated.</p> <p>Setting display: Display system setting state or auto sequence setting value.</p>
PRESET mode	<p>The value of the setting entered on the right display changes depending on the operating MODE that has been selected</p> <ul style="list-style-type: none">• If CC mode is selected the right display provides setting in amps "A".• If CR mode is selected the right display provides setting in ohms "Ω".• If CP mode is selected the right display provides setting in watts "W".• If CV mode is selected the right display provides setting in volts "V".
LIMIT	<p>Each press of the LIMIT button changes the middle LCD text. The sequence and the corresponding setting value shown on the bottom display is as follows:</p> <ul style="list-style-type: none">• Set CC + CV or CP + CV upper limit voltage, the middle of the display show "+C.V", right display set value, the unit is V.• V_Hi (left limit voltage) displays the set value in volts "V".• V_Lo (right limit voltage) displays the set value in volts "V".• I_Hi (left limit current) displays the set value in amps "A".• I_Lo (right limit current) displays the set value in amps "A".• W_Hi (left limit power) displays the set value in watts "W".• W_Lo (right limit power) displays the set

- value in watts "W".
 - NG displays whether the NG flag is set to "ON" or "OFF".
- DYN Setting
- Each press of the DYN setting button changes the text on the middle LCD. The sequence and the corresponding setting value shown on the bottom display are as follows:
- T-Hi (time high) displays the set value in milliseconds "ms".
 - T-Lo (time low) displays the set value in milliseconds "ms".
 - Rise (current rise time/slew rate) displays the set value in "A/us".
 - Fall (current fall time/slew rate) displays the set value in "A/us".
 - SUR.I displays the set value in "A".
 - NOR.I displays the set value in "A".
 - S.TIME displays the set value in "ms".
 - S.STEP displays the set value 1-5.
- CONFIG
- Each press of the CONFIG button changes the middle LCD Text.
- The sequence and the corresponding setting value shown on the bottom displays are as follows:
- SENSE can be set to "AUTO" or "ON"
 - LDon (load ON voltage) displays the set value in volts "V"
 - LDOff (load OFF voltage) displays the set value in volts "V"
 - POLAR (load polarity) can be set to "+LOAD" or "-LOAD"
 - AVG
 - TURBO
 - EXTIN

- SHORT test
- CV_bW
 - This allows the parameters of the short test to be set up. Each press of the SHORT button moves the setting function. The sequence of the short test along with the setting value is as follows:
 - Short Press Start (pressing the START/STOP button starts the test).
 - TIME shows the duration of the SHORT test. "CONTI", on the bottom display indicates continuous. Time can be adjusted in "ms".
 - V-Hi (voltage high threshold) displays the set value in volts "V"
 - V-Lo (voltage low threshold) displays the set value in volts "V"

When the test is started the right display will show RUN. When the test has finished the right display will show END.

- OPP test
- This allows the parameters of the over power protection test to be Set up. Each press of the OPP button moves the setting function. The sequence of the OPP test along with the setting value is as follows:
- OPP Press Start (pressing the red START/STOP button starts the test)
 - PSTAR (power start point) right display provides setting in watts "W"
 - PSTEP (power steps) right display provides setting in watts "W"
 - PSTOP (power stop point) right display provides setting in watts "W"
 - VTH (voltage threshold) right display provides setting in volts "V"

When the test is started the right display will show the power value being taken by the load.

If the Device under Test is able to supply the load according to the values set then the middle display will show PASS and the right display will show the maximum power taken during the OPP test. If, during the test, OTP is displayed the over temperature Protection has been engaged. Similarly if OPP is shown on the display The over power protection has been activated.

OCP test

This allows the parameters of the over current protection test to be set up. Each press of the OCP button moves the setting function.

The sequence of the OCP test along with the setting value is as follows:

- OCP Press Start (pressing the red START/STOP button starts the test)
- ISTAR (current start point) right display provides setting in amps "A"
- ISTEP (current steps) right display provides setting in amps "A"
- ISTOP (current stop point) right display provides setting in amps "A"
- VTH (voltage threshold) right display provides setting in volts "V"

When the test is started the right display will show the current value being taken by the load. If the Device under Test is able to supply the load according to the values set then the middle display will show PASS and the Right display will show the maximum current taken during the OCP test. If during the test, OTP is displayed the over temperature protection has been Engaged. Similarly if OPP is shown on the display the over power protection has been activated.

Normal mode	In normal mode the right 5 digit displays shows the power consumption in Watts (W).
Setting mode	The right display together with the rotary adjustment knob is used to set values. The value changes according to the setting function that is active. The middle LCD provides a text message to tell the user which part of the setting menu is active.
14 Middle 5 digit LCD display	The middle 5 digit displays also changes function depending if the user is in normal mode or has entered a setting menu. Status display: When enter system setting or auto sequence mode, it displays setting status.
Normal mode	In normal mode the middle LCD display functions as a 5 digit ammeter. The 5 digit DAM shows the load current flowing into the DC load when the Load is ON.
Setting mode	If CONFIG, LIMIT, DYN, SHORT, OPP or OCP buttons are pressed the middle LCD show a text message according to the setting function it is in. Each subsequent press of the button moves the display to the next available function. The sequence of each setting menu is detailed below <ul style="list-style-type: none"> • CONFIG: Sequence is "SENSE" → "LDon" → "LDoff" → "POLAR" → "AVG" → "TURBO" → "EXTIN" → "CV_bW" • LIMIT: Sequence is "AddCV" → "V_Hi" → "V_Lo" → "I_Hi" → "I_Lo" → "W_Hi" → "W_Lo" → "NG" • DYN setting: Sequence is "T-Hi" → "T-Lo" → "RISE" →

“FALL” → “SUR. I” → “NOR. I” →
 “S.TIME” → “S.STEP”

- SHORT:
 Sequence is “PRESS” → “TIME” → “V_Hi”
 → “V_Lo”
- OPP:
 Sequence is “PSTAR” → “PSTEP” →
 “PSTOP” → “Vth”
- OCP:
 Sequence is “ISTAR” → “ISTEP” → “ISTOP”
 “Vth”

When the test is started the right display will show the current value being taken by the load. If the Device under Test is able to supply the load according to the values set then the middle display will show PASS and the Right display will show the maximum current taken during the OCP test. If during the test, OTP is displayed the over temperature protection has been Engaged. Similarly if OPP is shown on the display the over power protection has been activated.

15 Mode and CC, CR, CV, CP indicators

There are four operating modes. These can be selected in turn by pressing the “MODE” key on the PEL-5000G series electronic load module. The sequence is:

- (CC) Constant Current
- (CR) Constant Resistance
- (CV) Constant Voltage
- (CP) Constant Power
- The appropriate LCD will illuminate according to the operating mode is selected.

FUNCTION DESCRIPTION

Function keys description	37
Test keys description.....	54
System and Memory keys description	76
Auto Sequence keys description	81
Test keys description.....	85

Function keys description

The function keys on the front panel of PEL-5000G series mainframe are designed for high testing throughput purpose. There are 150 operation states or testing steps can be store in the EEPROM memory of PEL-5000G series electronic load respectively, each state can store or recall the load status and level for electronic load simultaneously.



Mode and CC,
CR, CP, CV
Indicators



There are four operating modes. These can be selected in turn by pressing the “MODE” key on the PEL-5000G series Electronic Load module. The sequence is:

- (CC) Constant Current
- (CR) Constant Resistance
- (CP) Constant Power
- (CV) Constant Voltage

The appropriate LCD will illuminate according to the operating mode is selected.

Load key and
LED indicator



The input to the PEL-5000G series electronic load can be switched ON/OFF by using the “LOAD” button. Indication of the ON/OFF state is provided by illumination of the button.

LOAD button lit = LOAD ON (load sinks

according to the preset values)

LOAD button unlit = LOAD OFF (the load does not sink current)

Turning the LOAD OFF does not affect the preset values. When the LOAD ON state is enabled the unit will revert to sinking according to the preset values.

When the Load ON/OFF key is operated, the current taken by load will follow the RISE or FALL with time according to the preset rate. The current RISE and FALL times can be adjusted in the DYN Setting button of the front panel.

In addition to the LOAD ON/OFF function, the user can also adjust the voltage level at which the unit will automatically start or stop sinking energy. The adjustable LDon and LDoff voltage levels are found within the CONFIG menu.



Note

The LDoff level cannot be set higher than the LDon level.

Preset key and
LED indicator



If the Preset key is pressed, the button will become lit indicating that the Preset mode has been accessed. The lowest 5 digit display will change from showing the power consumption in watts to displaying the value to be preset. The value that can be programmed changes according to the operating mode that has been selected.

- Constant Current (CC) mode:
- The High and Low levels of load current can be preset at right 5 digit LCD. the "A" LED will be lit indicating the setting value is amps.
- Constant Resistance (CR) mode:

- The High and Low levels of load resistance can be preset on the right 5 digit LCD. The “Ω” LED will be lit indicating the setting value is ohms.
- Constant Voltage (CV) mode:
 - The High and Low levels of load voltage can be preset on the right 5 digit LCD. The “V” LED will be lit indicating the setting value is volts.
 - Constant Power (CP) mode:
 - The High and Low levels of load power can be preset on the right 5 digit LCD. The “W” LED will be lit indicating the setting value is watts.
 - Dynamic mode (CC, CR or CP modes only):
 - Each press of the DYN button cycles through the dynamic load settings. The DYN settings are used in conjunction with the High and Low levels of load current to define the dynamic waveform. Each press of the DYN button switches from T_Hi (time high), to T_Lo (time low), to Rise time and then to fall time. The middle LCD shows the section of the dynamic waveform which is programmed with the rotary knob and read from the right display. The “ms” LED shows that the settings are programmed in milliseconds.

DYN key and
LED
indicators



In the Dynamic mode, the LCD display **DYNAMIC** is in the ON state. Press it again to switch to the Static mode. At this time, the LCD display **STATIC** is in the ON state, and the PEL-5000G series electronic load is automatically adjusted

to the static mode.



Note

1. In the Static mode, the Low level gear changes with the High level gear.
2. The Rise/ Fall gear also changes with the high level gear.
3. Only Low/ High level changes are provided in CP mode.

Range key and LED indicators



This button can only be operated in CC mode and is used to control the range switch. If it is Range Auto, the LCD display **RANGE AUTO** is ON, it will automatically switch between range 1 or range 2 according to the value set by the user; otherwise, if it is Range 2, the LCD display **RANGE II** is ON.



Note

It is only possible to force RANGE II in CC mode.

Level key and LED indicators



The function of the Level key is to switch the High/ Low level of CC, CR, CV, CP in the Static mode, or switch the setting of High/ Low when Preset ON, when the LEVEL key is switched to the High level, the LCD display is ON; otherwise, the LCD display **LOW** is ON.

Limit key



The Limit button allows the user to set left and right thresholds for voltage, current or power. These threshold settings are used in conjunction with the NG function to flag when the load is operating outside the desired limits.

Each press of the Limit key enables a different value to be entered. On first press of the Limit key, the button will illuminate and +C.V will be displayed on the middle LCD. The setting is made with the rotary knob and can be read from the right LCD during setting.

The setting sequence is shown below:

- AddCV (CC + CURRENT LIMIT or CP+CV upper limit)
- V_Hi (DVM upper limit)
- V_Lo (DVM lower limit)
- I_Hi (DAM upper limit)
- I_Lo (DAM lower limit)
- W_Hi (DWM upper limit)
- W_Lo (DWM lower limit)
- NG OFF/ON (No Good Flag)
- LIMIT setting function OFF

The engineering unit is “V”, “A” or “W” depending on the threshold LIMIT being set.

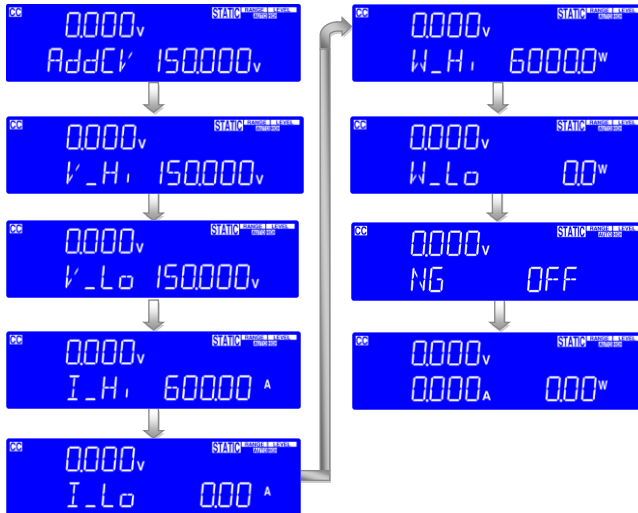

- Setting CC + CURRENT LIMIT or CP+CV upper limit voltage, middle 5 digit LCD display "AddCV", right 5 digit LCD display the unit is "V", The AddCV set range from 0.00V to 150.000V step 0.0025V by rotating the setting knob.

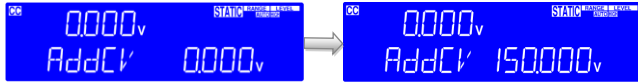

- Setting upper limit voltage VH , middle 5 digit LCD display "V-Hi", right 5 digit LCD display the unit is "V", the V-Hi set range from 0.00V to 150.000V step 0.0025V by rotating the setting knob.

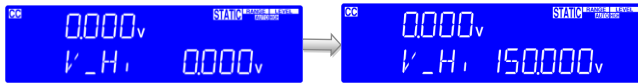

- Setting lower limit voltage VL, middle 5 digit LCD display "V-Lo", right 5 digit LCD display the unit is "V", the V-Lo set range from 0.00V to 150.000V step 0.0025V by rotating the setting knob.

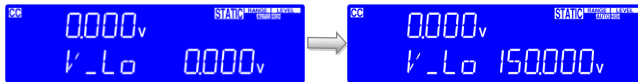

- Setting Upper limit current IH , middle 5 digit LCD display "I-Hi", right 5 digit LCD display the unit is "A", the I-Hi set range from 0.00A to 600.00A step 9.6mA by rotating the setting knob.

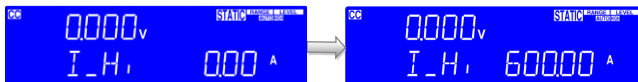

- Setting lower limit current IL , middle 5 digit LCD display “I-Lo “, right 5 digit LCD display the unit is “A”, the I-Lo set range from 0.000A to 600.00A step 9.6mA by rotating the setting knob.



- Setting upper limit power WH, middle 5 digit LCD display “W-Hi “, right 5 digit LCD display the unit is “W”, the W-Hi set range from 0W to 6000W step 96mW by rotating the setting knob.

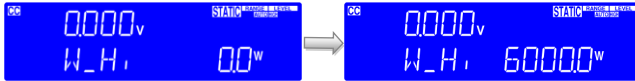

- Setting lower limit power WL, middle 5 digit LCD display “W-Lo” right 5 digit LCD display the unit is “W”, the W-Lo set range from 0W to 6000W step 96mW by rotating the setting knob.

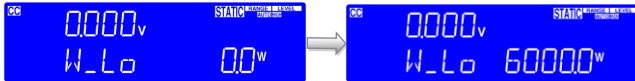

- Setting NG ON/OFF, When exceed VH, VL, IH, IL, WH, WL one of these whether NG on LCD display.

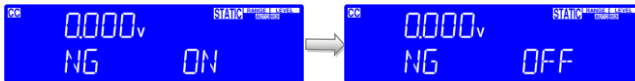

- CC mode, press Limit key to set the V-Hi and V-Lo voltage upper and lower limits of the GO / NG.

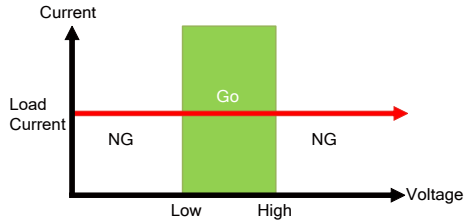

Limit

CC Dynamic mode, press Limit key to set the Level Hi and Level Low voltage upper and lower limits of the GO/ NG.

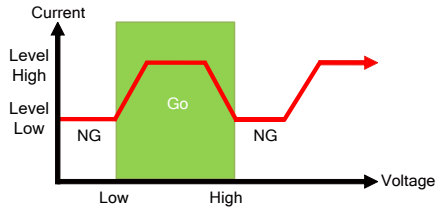

Limit

CR mode, press Limit key to set the V-Hi and V-Lo voltage upper and lower limits of the GO/ NG.

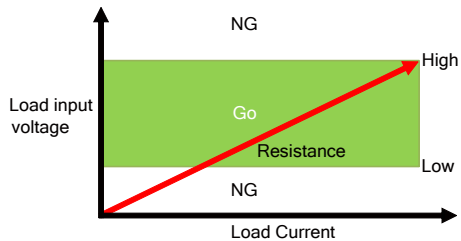

Limit

CV mode, press Limit key to set the I-Hi and I-Lo Current upper and lower limits of the GO/ NG.

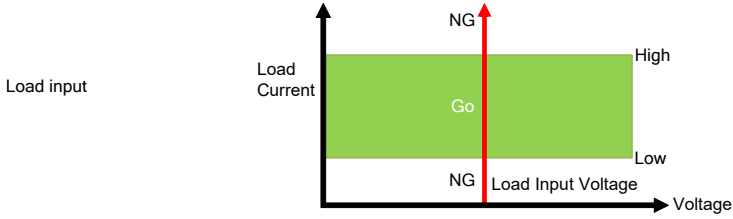

Limit

CP mode, press Limit key to set the W-Hi and W-Lo power upper and lower limits of the GO / NG.

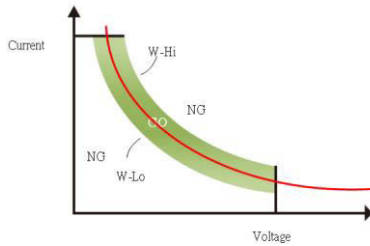

DYN setting key

DYN Setting

The DYN button allows the user to define the timings of the dynamic load waveform firstly the high and low levels of load current will need to be set via the Level switch. The RISE and FALL times between the low load current and the high load current along with the TIME the waveform is HIGH and the TIME LOW can is set via the DYN menu.

Each press of the DYN key enables a section of the DYNAMIC waveform to be set. On first press of the DYN key the button will illuminate and T-Hi will be displayed on the middle LCD. The value is adjusted with the rotary knob and can be read from the right LCD during setting. The setting sequence is shown below:

- T_Hi (time the waveform is high)

- T_Lo (time the waveform is low)
- RISE (rise time)
- FALL (fall time)
- SUR. I
- NOR. I
- S.TIME
- S.STEP
- DYN setting function OFF
- The time that the waveform is high includes the rise time and is set in "ms".

The time that the waveform is low includes the fall time and is set in "ms".

The RISE and FALL time is set in "A/ μ s".
The actual engineering unit is shown on the right of the right 5 digit display

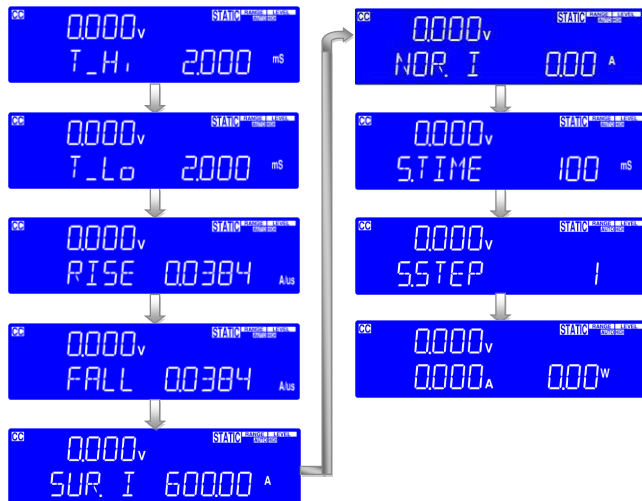

- Press DYN Setting key, LED will ON and setting level high period, middle 5 digit LCD display will show "T-Hi", right 5 digit LCD display will show setting value, the unit is "ms", The T-Hi set range from 0.010 ms to 9999 ms step 0.001ms by rotating the setting knob.

There are four ranges from 0.010 ms to 9999 ms, the ranges are below:

- Range 1: 0.010ms~9.999ms
- Range 2: 10.00ms~99.99ms
- Range 3: 100.0ms~999.9ms
- Range 4: 1000ms~9999ms

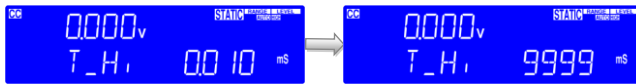

- Setting level Low period, middle 5 digit LCD display will show "T-Lo", right 5 digit LCD display will show setting value, the unit is "ms", The T-Lo set range from 0.010 ms to 9999 ms step 0.001ms by rotating the setting knob.

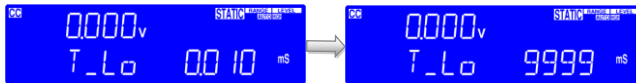

- Setting rise time, middle 5 digit LCD display will show "RISE", right 5 digit LCD display will show setting value, the unit is "A/μs", the RISE time set range from 0.3840A/μs to 24.000A/μs step 0.096A/μs by rotating the setting knob.

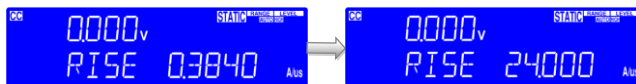

- Setting fall time, middle 5 digit LCD display will show “FALL”, right 5 digit LCD display will show setting value, the unit is “A/μs”, the FALL time set range from 0.3840A/μs to 24.000A/μs step 0.096A/μs by rotating the setting knob.

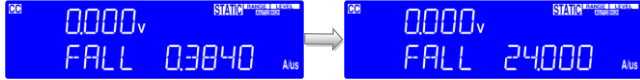

- Setting surge current, middle 5 digit LCD display will show “SUR. I”, right 5 digit LCD display will show setting value, the unit is “A”, the surge current set range from 0.00A to 900.00A step 14.4mA by rotating the setting knob.

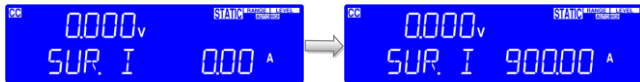

- Setting NOR current, middle 5 digit LCD display will show “NOR. I”, right 5 digit LCD display will show setting value, the unit is “A”, the NOR current set range from 0.00A to 450.00A step 14.4mA by rotating the setting knob.



- Setting S.TIME, middle 5 digit LCD display will show “S.TIME”, right 5 digit LCD display will show setting value, the unit is “ms”, the S.TIME set range from 10 to 2000ms step 10ms by rotating the setting knob.

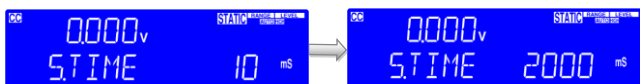

- Setting S.STEP, middle 5 digit LCD display will show “S.STEP”, right 5 digit LCD display will show setting value, the S.STEP set range from 1 to 5 step 1 by rotating the setting knob, Press the Start button to start the test.

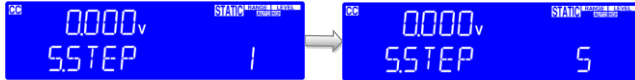

- Set the number of SURGE as shown in the figure.

Setting fig explanation

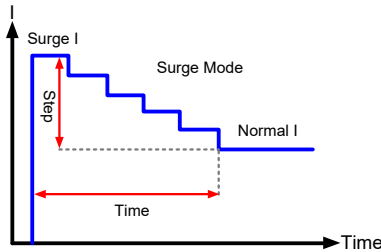

CONF key



The CONF key allows the sense function to engage automatically or switched ON. The CONF key also enables the LOAD to automatically turn ON/OFF when a voltage level is reached. The polarity symbol can also be switched via the CONF menu.

Each press of the CONFIG key moves the menu on one step. On first press of the CONFIG key the button will illuminate and SENSE will be displayed on the middle LCD. The value is adjusted with the rotary knob and can be read from the right LCD during setting.

The setting sequence is shown below:

- SENSE (AUTO or ON)
- LDon

(Voltage at which LOAD turns ON)

- LDoff
(Voltage at which LOAD turns OFF)
- POLAR (change polarity symbol)
- AVG
- TURBO
- EXTIN
- CV_bW
- Exit CONFIG options

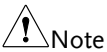
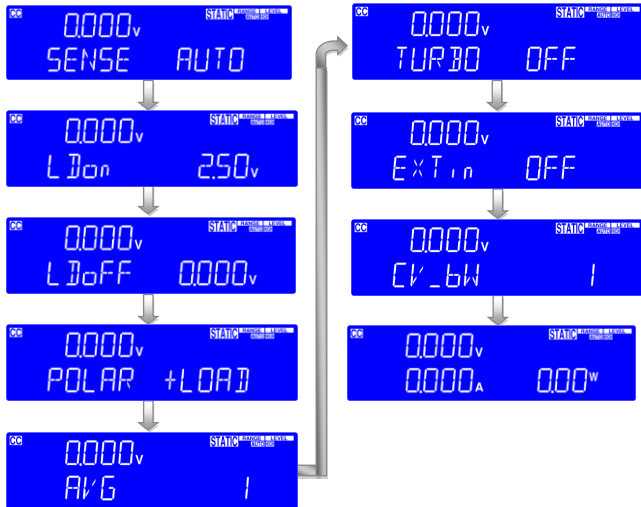

Note

- The adjustable LDon (LOAD ON) voltage is valid for CC, CR & CP operating modes. The adjusted LDon voltage will not operate in CV mode.
- The LDon (LOAD ON) voltage setting cannot be lower than the LDoff (LOAD OFF) voltage. If 0V is required for both LOAD ON and LOAD OFF make the LOAD OFF adjustment first.

- Set vsense and load input switching methods, the middle of the 5 digit LCD display will show "SENSE", right 5 digit LCD display will show "AUTO" or "ON".

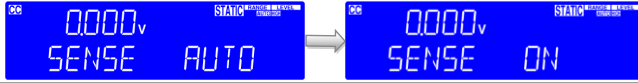

- Set Load ON voltage, the middle of the 5 digit LCD display will show "LDon", right 5 digit LCD display will show setting value, the units is V, the Load ON voltage set range from 0.25V to 62.5V. If the load is greater than the input voltage Load ON voltage setting, the electronic load current begin to load on.

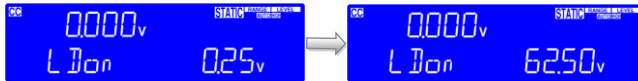

CC/CR/CP MODE is controlled by Load ON voltage, CV MODE is not controlled by Load ON voltage.

- Set Load OFF voltage, the middle of the 5 digit LCD display will show "LDoFF", right the 5 digit LCD display will show settings value, the units is V, The Load OFF voltage set range from 0.0V to 62.250V. If the load input voltage is less than Load OFF setting voltage, the electronic load to load off.

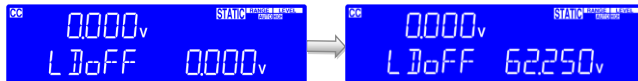

- Set Load polarity, the middle of the 5 digit LCD display will show "POLAR", right the 5 digit LCD display will show "+LOAD" or "-LOAD", use the setting knob to set "+LOAD" or "-LOAD".

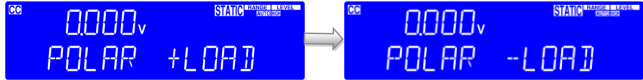

- Set AVG, the middle of the 5 digit LCD display will show “AVG”, the right 5 digits LCD display “1”, the AVG setting range from 1 to 64 steps 1 by rotating the setting knob.

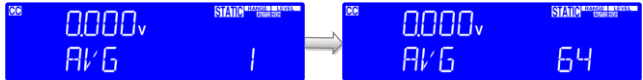

- Setting TURBO middle of the 5 digit LCD display will show “TURBO”, the right the 5 digit LCD display “OFF” or “ON”, the TURBO setting by rotating the setting knob to ON or OFF.



- Setting EXTIN middle of the 5 digit LCD display will show “EXTIn”, right the 5 digit LCD display “OFF” or “ON”, the EXTIN setting by rotating the setting knob to EXTIN ON or EXTIN OFF.

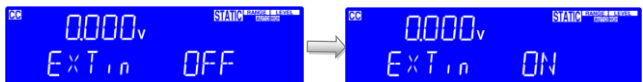

- Setting CV_bW middle of the 5 digit LCD display will show “CV_bW”, right the 5 digit LCD display “1”, the CV_bW setting range from 1 to 4, 4 is the fastest, steps 1 by rotating the setting knob, the initial value is 1.



Test keys description

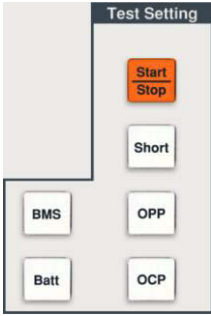

Short key

Short

- Set Short mode
The Setting key allows the parameters of a SHORT circuit test to be entered. The SHORT test will attempt to sink high current up to the PEL-5000G series load maximum current in order to check the power source's protection and behavior. The test time can be adjusted and threshold values for the High and low voltage limits set.
- Pressing the Setting key once will cause the button to illuminate. The Message "SHORT PRESS START" will be shown across the 3 displays.
- Each press of the Short key moves the menu on one step. The left and middle LCD show the currently selected test parameter as text. The value is adjusted by the rotary knob and can be read from the right display during setting.

The setting sequence is shown below:

- SHORT PRESS START (pressing the start/stop key starts test)

- SHORT Time (CONTI = Continuous or 100ms to 10,000ms possible)
- SHORT V_{Hi} (High voltage threshold setting)
- SHORT V_{Lo} (Low voltage threshold setting)
- Exit SHORT test set-up



- Set the short test time, the LCD display show “SHORT” on left 5 digits LCD display, shows “TIME” on middle 5 digits LCD display, right 5 digit LCD display “CONTI”, the unit is “ms”.



- TIME: Set the short test time, The LCD display show “SHORT” on left 5 digits LCD display, shows “TIME” on middle 5 digits LCD display the unit is “ms”, and shows “CONTI” on right 5 digits LCD display, the setting range is “CONTI” means continue, 100mS to 10000mS step 100mS by clockwise rotate the setting knob. The short test will be no time limitation when setting to CONTI until press “Start/Stop” key to stop the short test.

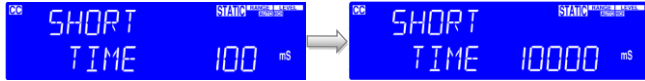

- V-Hi : Short test voltage check upper limitation setting, the LCD display shows "SHORT" on left 5 digit LCD display, middle 5 digit LCD display "V-Hi", right 5 digit LCD display setting value, the unit is "V". The V-Hi setting range from 0.00V to 600.00V and each step is 0.0025V by rotating the setting knob.

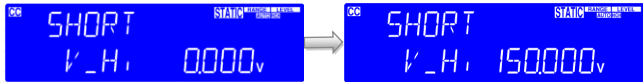

- V-Lo : Short test voltage check lower limitation setting, the LCD display shows "SHORT" on left 5 digit LCD display, middle 5 digit LCD display "V-Lo", right 5 digit LCD display setting value, the unit is "V". The V-Lo setting range from 0.00V to 150.000V and each step 0.0025V by rotating the setting knob.

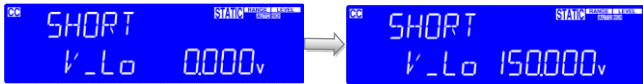

Once the test parameters have been entered, the test is started by pressing the Start/Stop button while the SHORT PRESS START text is displayed. During the test the bottom LCD will show run and the actual short current will be displayed on the right upper LCD.



- The message PASS END will be displayed if the measured voltage levels stay within the V-Hi and V-Lo threshold levels during the test.
- The message FAIL END will be displayed if the measured voltage levels fall outside the V-Hi and V-Lo threshold levels during the test. The NG flag will also illuminate.

- If continuous short time is selected the test is ended by pressing the Start/Stop button.

OCP
parameters
setting

OCP

The OCP key allows the parameters of an over current protection test to be entered. The OCP test will ramp up the load current in steps to validate the device under test's (DUT) protection and behavior. A voltage threshold level can be set. If the voltage measured during the test is lower than the set threshold voltage then the test will fail and the display will signal OCP ERROR. Similarly a current Threshold (I STOP) can be set. If the measured current reaches the I STOP threshold, the test will be discontinued and the OCP ERROR message will be displayed.

Press the Setting key once will cause the button to illuminate. The message "OCP PRESS START" will be shown across the 3 displays.

OCP

Each press of the OCP button moves the menu on one step. The left and middle LCDs show the currently selected test parameter as text. The value is adjusted by the rotary knob and can be read from the right display during setting.

The setting sequence is shown below:

- OCP VTH OCP PRESS START (pressing the red start/stop key starts test)
- OCP I STAR (current starting point of the OCP test)
- OCP I STEP (value of incremental current steps from I START)
- OCP I STOP (the OCP test's upper current threshold)

- OCP Vth (the voltage threshold setting)
- Exit OCP test set-up



- ISTAR: Set the start current point, the LCD display shows “OCP” on left 5 digit LCD display, middle 5 digit LCD display “ISTAR”, right 5 digit LCD display setting value, the unit is “A”. The setting range is 0.00A to the full scale of the CC mode specification. The setting is by rotating the setting knob, resolution: 9.6mA.

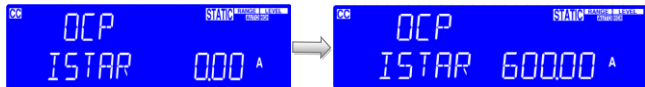

- ISTEP: Set the increment step current point, the LCD display shows “OCP” on left 5 digit LCD display, middle 5 digit LCD display “ISTEP”, right 5 digit LCD display setting value, the unit is “A”. The setting range is 0.00A to the full scale of the CC mode specification. The setting is by rotating the setting knob, resolution: 9.6mA.

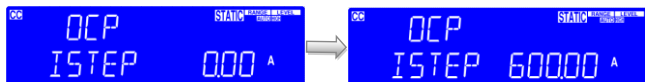

- **ISTOP**: Set the stop current point, the LCD display shows “OCP” on left 5 digit LCD display, middle 5 digit LCD display “ISTOP”, right 5 digit LCD display setting value, the unit is “A”, the setting range is 0.000A to the full scale of the CC mode specification. The setting is by rotating the setting knob, resolution: 9.6mA.

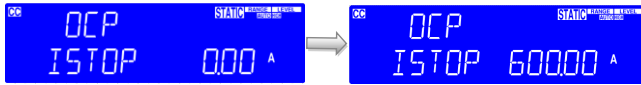

- **Vth**: Set the threshold voltage; the LCD display shows “OCP” on left 5 Digit LCD display, middle 5 digit LCD display “Vth”, right 5 digit LCD display setting value, the unit is “V”, the setting range is 0.00V to the full scale of the voltage specification. The setting is by rotating the setting, resolution: 0.0025V.

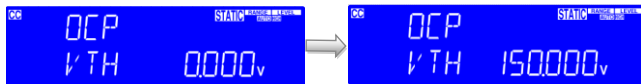

Once the test parameters have been entered, the test is started by pressing the red Start/Stop button while the OCP PRESS START text is displayed. During the test, the middle LCD will show run and the actual current being taken will be displayed on the right LCD.

 Note

- The message OCP ERROR will be displayed if the DUT fails the test. The reasons for failure are due to one of the following conditions:
 - (a) the voltage level of the DUT falls below the set voltage threshold (OCP Vth) during the test
 - (b) The current taken from the DUT reaches the OCP I STOP setting.

- The message PASS will be displayed if the DUTs voltage stays above the set threshold. Also to PASS the OCP test the current taken from the DUT cannot equal the I STOP setting.
- If the DUT passes the OCP test the maximum current taken during the test is displayed on the right LCD. Upon PASS or OCP ERROR the test will automatically stop. The Start/Stop button can be used during the test to immediately cease operation.

OPP
parameters
setting



The OPP allows the parameters of an over power protection test to be entered. The OPP test will ramp up the load power in steps to validate the device under test's (DUT) protection and behavior. A voltage threshold level can be set. If the voltage measured during the test is lower than the set Threshold voltage then the test will fail and the display will signal OPP ERROR. Similarly a power threshold (P STOP) can be set. If the measured power reaches the P STOP threshold the test will be discontinued and the OPP ERROR message will be displayed.

Press the Setting key once will cause the button to illuminate. The message "OPP PRESS START" will be shown across the displays.



Each press of the OPP button moves the menu on one step. The left and middle LCDs show the currently selected test parameter as text. The value is adjusted by the rotary knob and can be read from the right display during setting.

The setting sequence is shown below:

- OPP PRESS START (pressing the red start/stop key starts test)

- OPP P STAR
(power starting point of the OPP test)
- OPP P STEP (value of incremental current steps from P START)
- OPP P STOP (the OPP test's upper threshold power limit)
- OPP Vth (the voltage threshold setting)
- Exit OPP test set-up

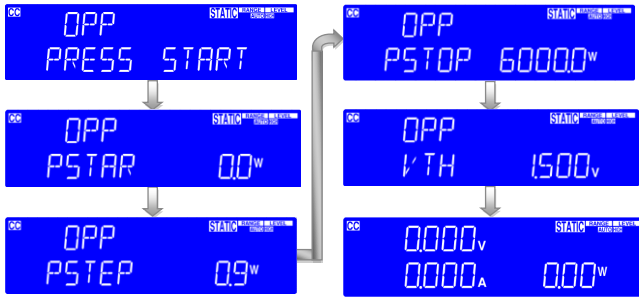

- PSTAR: Set the start power, the LCD display shows “OPP” on left 5 digit LCD display, middle 5 digit LCD display “PSTAR”, right 5 digit LCD display setting value, the unit is “W”. The setting range is 0.00W to the full scale of the CP mode specification. The setting is by rotating the setting knob, resolution: 96mW.

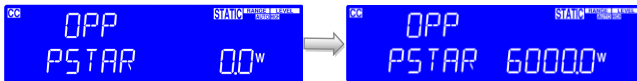

- **PSTEP:** Set the increment step power, the LCD display shows “OPP” on left 5 digit LCD display, middle 5 digit LCD display “PSTEP”, right 5 digit LCD display setting value, the unit is “W”. The setting range is 0.00W to the full scale of the CP mode specification. The setting is by rotating the setting knob, resolution: 96mW.

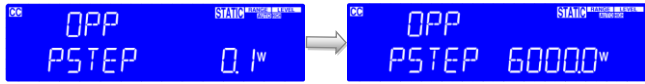

- **PSTOP:** Set the stop power, the LCD display shows “OPP” on left 5 digit LCD display, middle 5 digit LCD display “PSTOP”, right 5 digit LCD display setting value, the unit is “W”, the setting range is 0.00W to the full scale of the CP mode specification. The setting is by rotating the setting knob, resolution: 96mW.

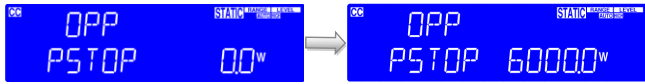

- **Vth:** Set the threshold voltage; the LCD display shows “OPP” on left 5 digit LCD display, middle 5 digit LCD display “Vth”, right 5 digit LCD display setting value, the unit is “V”, the setting range is 0.00V to the full scale of the voltage specification. The setting is by rotating the setting knob, resolution: 0.0025V.

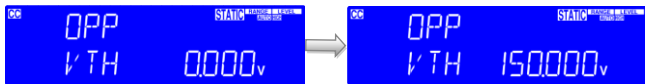



Once the test parameters have been entered, the test is started by pressing the red Start/Stop button while the OPP PRESS START text is displayed. During the test, the middle LCD will show run and the actual current being taken will be displayed on the right LCD.



Note

- The message OPP ERROR will be displayed if the DUT fails the test. The reasons for failure are due to one of the following conditions:
 - (a) the voltage level of the DUT falls below the set voltage threshold (OPP Vth) during the test
 - (b) The current taken from the DUT reaches the OPP P STOP setting.
- The message PASS will be displayed if the DUT's voltage stays above the set threshold. Also to PASS the OPP test the current taken from the DUT cannot equal the I STOP setting.
- If the DUT passes the OPP test the maximum current taken during the test is displayed on the right LCD. Upon PASS or OPP ERROR the test will automatically stop. The Start/Stop button can be used during the test to immediately cease operation.

Start/Stop key



The Start/Stop key is used in conjunction with the SHORT, OCP or OPP test functions. It is used to start a test according to the set parameters or to stop a test before PASS or FAIL is signaled. Please refer to the preceding sections for more information on the SHORT, OCP and OPP tests.

Battery key and LED indicator

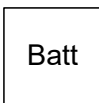

Batt DISch is the battery discharge setting.



The sequence of Batt DISch setting is as

follows:

There are 5 parameters for the DISch test function, as the parameters of CC, VOLT.V, TIME.S, CAP.AH and CAP.WH.

Batt	Press the Batt button again to set stop discharge voltage VOLT.V(=UVP:Under Voltage Protect), set stop discharge time TIMES.S, set stop discharge capacity CAP.AH, set stop discharge capacity CAP.wH
-------------	---

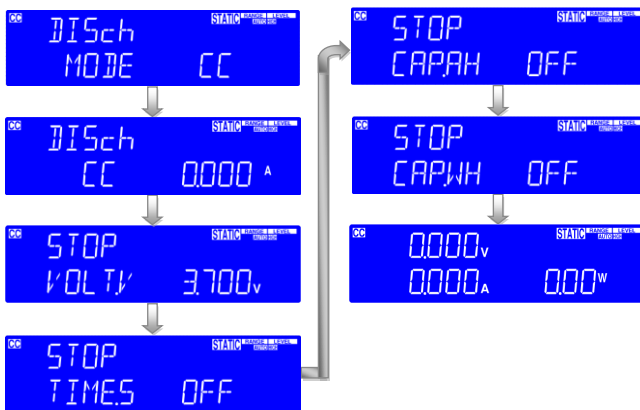

- Set the battery discharge CC mode, DISCH CC. The upper left LCD shows "DISch", the lower left 5-digit display on the left displays "CC", the setting range is from 0.000A to full scale, resolution: 9.6mA.



- Set the stop discharge voltage STOP "VOLT.V", the 5 digit display in the middle displays "VOLT.V", and the 5-digit display below displays the setting value in V. The setting range of STOP VOLT.V is from 0.00V to full scale, resolution: 0.0025V.

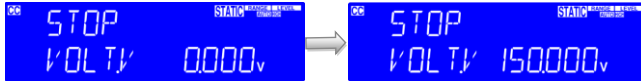

- Set the stop discharge time, set STOP TIME.S, the lower left 5 digit display shows "TIME.S", the bottom 5 digit display shows the setting value, the setting range of STOP TIME.S is from OFF to 99999 and each step is 1S by rotating the setting knob.

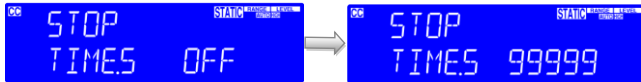

- Set stop CAP.AH, set STOPCAP.AH, the lower left middle 5-digit display shows "CAP.AH", the lower 5-digit display shows the setting value, the setting range of STOP CAP.AH is from OFF to 19999.9 and each step is 0.1AH by rotating the setting knob.

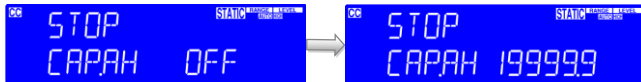

- Set stop CAP.WH, set STOPCAP.WH, the lower left middle 5-digit display shows "CAP.WH", the lower 5-digit display shows the setting value, the setting range of STOP CAP.WH is from OFF to 19999.9 and each step is 0.1WH by rotating the setting knob.

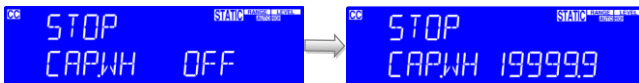

The sequence of Batt DISch CP setting is as follows:

There are 5 parameters for the DISch test function, as the parameters of CP, VOLT.V, TIME.S, CAP.AH and CAP.WH.

Batt

Press the Batt button again to set stop discharge voltage VOLT.V(=UVP: Under Voltage Protect), set stop discharge time TIMES.S, set stop discharge capacity CAP.AH, set stop discharge capacity CAP.wH

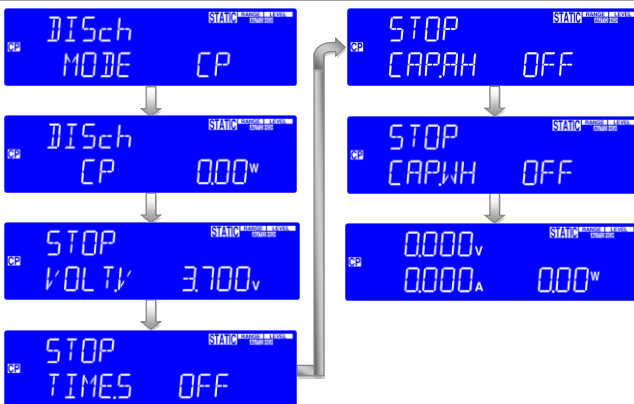

- Set the battery discharge CP mode, DISCH CP. The upper left LCD show "DISch", the lower left 5-digit display on the left displays "CP", the setting range is from 0.000W to full scale, resolution: 9.6mW.

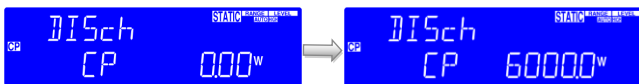

- Set the stop discharge voltage STOP "VOLT.V", the 5 digit display in the middle displays "VOLT.V", and the 5-digit display below displays the setting value in V. The setting range of STOP VOLT.V is from 0.00V to full scale, resolution: 0.0025V.

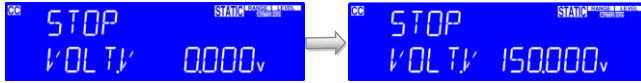

- Set the stop discharge time, set STOP TIME.S, the lower left 5 digit display shows "TIME.S", the bottom 5 digit display shows the setting value, the setting range of STOP TIME.S is from OFF to 99999 and each step is 1S by rotating the setting knob.

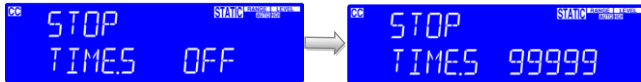

- Set stop CAP.AH, set STOPCAP.AH, the lower left middle 5-digit display shows "CAP.AH", the lower 5-digit display shows the setting value, the setting range of STOP CAP.AH is from OFF to 19999.9 and each step is 0.1AH by rotating the setting knob.

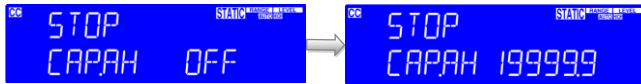

- Set stop CAP.WH, set STOPCAP.WH, the lower left middle 5-digit display shows "CAP.WH", the lower 5-digit display shows the setting value, the setting range of STOP CAP.WH is from OFF to 19999.9 and each step is 0.1WH by rotating the setting knob.

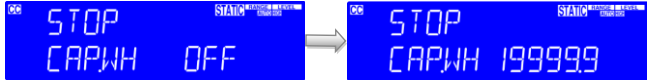

BMS SHORT
test

Short

BMS SHORT test setting parameters, the setting Sequence is shown below:

- SHORT PRESS START
- SHORT TIME
- SHORT ITH

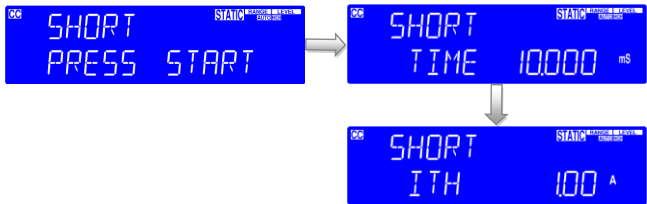

To test the protection status of BMS P+, P- terminal short circuit, PEL-5000G series will measure the peak current, protection time, short circuit test sequence as shown in the figure below, setting method: Press the Short key to set the Short time (0.010~10.000ms, default 10ms), Ith (0.01~300A), then return to the “SHORT PRESS START” screen, press the Start key to start the test, Load will automatically load the maximum specification current (PEL-5006G-150-600 = 600A), the DISPLAY will display “SHORT TEST” during the test, and the LCD will display When the test is over. Peak current (Peak current), and display protection time (Protect time).

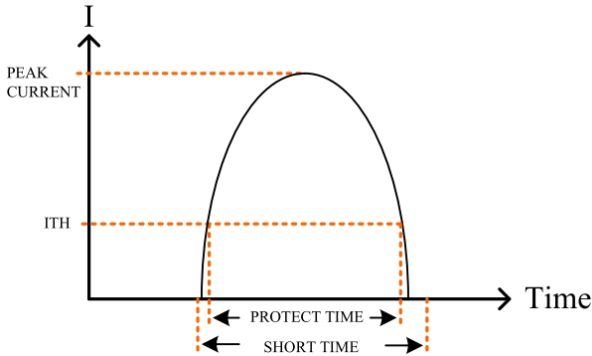
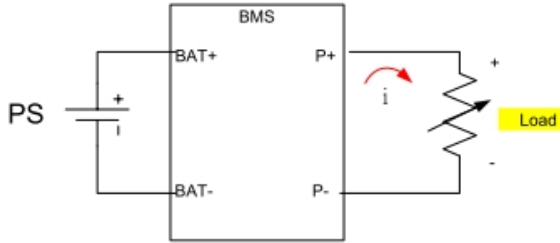

- Setting the BMS Short Time, the upper 5 digit monitor display the “SHORT”, the middle 5 digit monitor display the “TIME”, and lower monitor display setting value, the unit is “ms”. The range is 0.05ms to the 10.000ms, step 0.01ms by rotating the setting knob.

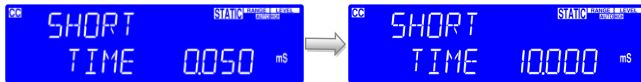

- Setting the BMS Short ITH current, the upper 5 digit monitor display the “SHORT”, the middle 5 digit monitor display the “ITH”, and lower monitor display setting value, the unit is “A”. The range is 0.28A to the 300.00A, step 0.01A by rotating the setting knob.

All models of
SHORT ITH

Model	SHORT ITH
PEL-5004G-150-400	200A
PEL-5005G-150-500	250A
PEL-5006G-150-600	300A
PEL-5004G-600-280	140A
PEL-5005G-600-350	175A
PEL-5006G-600-420	210A
PEL-5004G-1200-160	80A
PEL-5005G-1200-200	100A
PEL-5006G-1200-240	120A

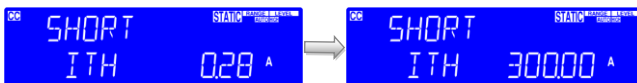

BMS OCP Test

Short

• BMS OCP test setting parameters, the Setting Sequence is shown below:

- OCP PRESS START
- OCP ISTAR
- OCP TSTEP
- OCP ISTEP
- OCP ISTOP
- OCP ITH

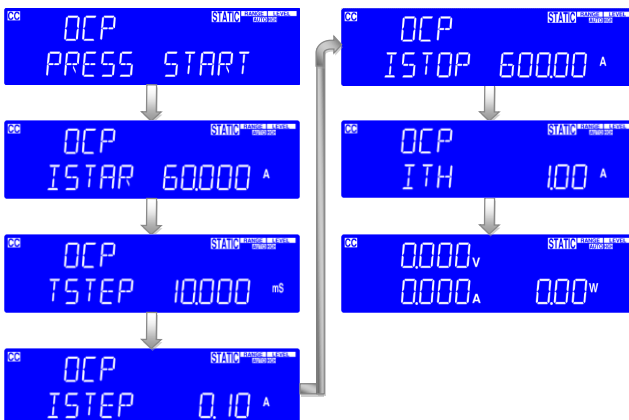

To test the protection state of overcharge or over discharge of BMS, PEL-5000G series will measure the current of overcharge or over discharge, protection time, OCCP/OCDP (Over Current Charge/ Discharge Protection) are all tested by OCP, and the difference is in POWER & LOAD Different from the BMS connection method, the setting method: Press the OCP key to set I_{start} , T_{step} , I_{step} , I_{stop} , I_{th} ($0.01A \sim <I_{start}$), press the Start key to start the test Load Load from I_{start} and set the time out (T_{step}), if the protection does not occur within this time, increase the current I_{step} (if I_{step} is set to 0, it will end directly), until the protection occurs or I_{stop} is reached, the DISPLAY displays "OCP TEST" during the test, and the second line of the LCD when the test ends Displays the OCP current, and the third row displays the protection time. When the test method is a PULSE, you only need to set I_{start} and T_{step} , and then press the Start key to start the test (I_{step} is preset to 0)

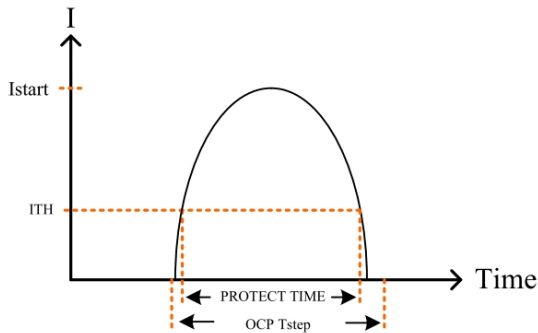

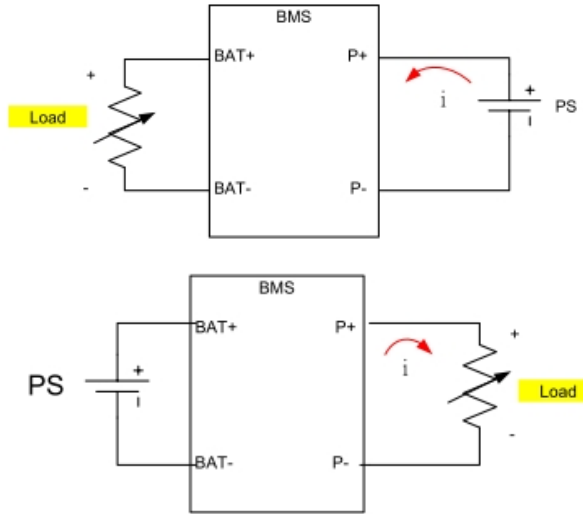
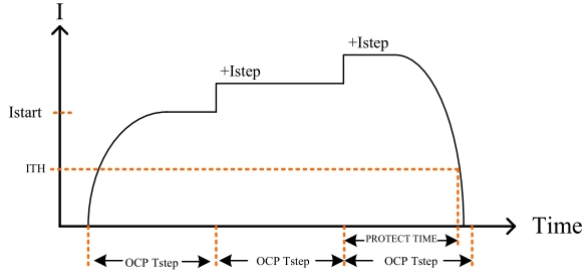

- Setting the BMS OCP ISTAR current, the upper 5 digit monitor display the "OCP", the middle 5 digit monitor display the "ISTAR", and lower monitor display setting value, the unit is "A". The range is 0.96A to the 600.00A, step 9.6mA by rotating the setting knob.

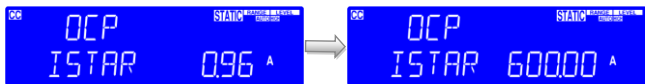

- Setting the BMS OCP TSTEP, the upper 5 digit monitor display the "OCP", the middle 5 digit monitor display the "TSTEP", and lower monitor display setting value, the unit is "ms". The range is 0.05ms to the 1000ms, step 0.01ms by rotating the setting knob.

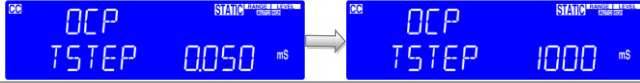

- Setting the BMS OCP ISTEP current, the upper 5 digit monitor display the "OCP", the middle 5 digit monitor display the "ISTEP", and lower monitor display setting value, the unit is "A". The range is 0.00A to the 600.00A, step 9.6mA by rotating the setting knob.

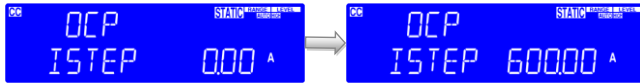

- Setting the BMS OCP ISTOP current, the upper 5 digit monitor display the "OCP", the middle 5 digit monitor display the "ISTOP", and lower monitor display setting value, the unit is "A". The range is 0.96A to the 600.00A, step 9.6mA by rotating the setting knob.

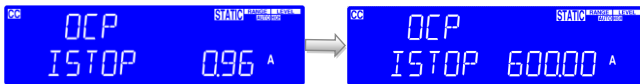

- Setting the BMS OCP ITH current, the upper 5 digit monitor display the "OCP", the Middle 5 digit monitor display the "ITH", and lower monitor Display setting value, the unit is "A". The range is 0.29A to the 300.00A, step 9.6mA by rotating the setting knob.

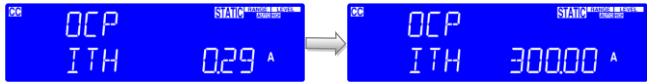

System and Memory keys description

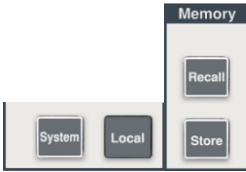

System key



Press SYSTEM to set the argument, GPIB address, RS232 BAUD- RATE, WAKE UP buzzer Alarm power ON/OFF and Master/Slave parallel control.



Local key



Press Local key to exit remote mode

Recall and Store keys



Recall and Store keys are used for Load state setting.

Set GPIB address



First press System key, the LCD display shows GPIB on left 5 digit LCD display, middle 5 digit LCD display Addr, right 5 digit LCD display setting GPIB address of the representative, press up, down buttons to adjust the GPIB address 1~30, and then press ENTER, PEL-5000G series GPIB address value is saved, press System key four times to leave the GPIB address configuration state.

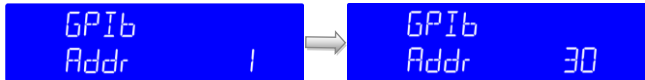

Set RS232 BAUD RATE



X2

Press the System key twice, the LCD display shows RS232 on left 5 digit LCD display, middle 5 digit LCD display baud, right 5 digit LCD display setting BAUD-RATE, press up, down buttons to adjust the value of BAUD RATE, then press ENTER, PEL-5000G series is saved setting BAUD RATE, press System key three times to leave the BAUD-RATE setting state.



WAKE-UP function



X3

This function is designed for auto setting the load status and load level in turning on the PEL-5000G series every time. Press the System key three times, the LCD display shows WAKE on left 5 digit LCD display, middle 5 digit LCD display UP, right 5 digit LCD display setting, press up, down buttons to adjust the 0~150.

Press Enter key to be stored, press system key twice to leave the WAKE-UP setting state. If set to "0" means do not call.

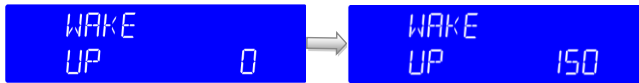

Buzzer ON/OFF

This is the test set automatically (AUTO SEQUENCE) at the end, if it increases buzzer function, if set to ON, then when the test result is PASS automatically when the buzzer will call out, if the test result is FAIL when the buzzer will call the second tone.



X4

Setting method:

Press System key four times and the LCD display shows SEQ. on left 5 digit LCD display, middle 5 digit LCD display bEEP, right 5 digit LCD display setting ON or OFF, press up and down keys to adjust.

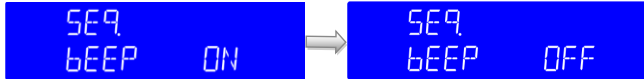

- Setting system parameters, if the input is required to use the KEYPAD ENTER button to confirm, otherwise PEL-5000G series will not save the changes the settings.
- Pass: Automatic test mode, no NG state, is the PASS.
Fail: Automatic test mode, any test if the NG then is the FAIL.

Recall key

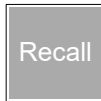

Recall/ Store load state settings

The function keys on the front panel of PEL-5000G series mainframe are designed for high testing throughput purpose. There are 150 operation states or testing steps can be store in the EEPROM memory of PEL-5000G series electronic load respectively, each state can store or recall the load status and level for electronic load simultaneously.

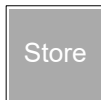
STORE
process

- Set the load status and load level.
- Press the Store key to enter the storage state.
- Press up, down keys or keypad to adjust.
- Press the Enter key to save the STATE.

RECALL
operation



- Press Recall key to enter the call state.
 - Press up, down keys or keypad to adjust.
 - Finally, press the Enter key to confirm. In the front panel of electronic load, set the value that would call out the information in accordance with resetting.
-

Auto Sequence keys description

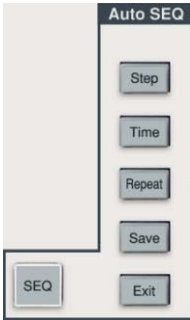

AUTO SEQUENCE instructions

PEL-5000G series has AUTO SEQUENCE function, PEL-5000G series to select the state F1~F9 Automatic testing can be edited, 16 steps each group can be set to select 150 group of the STATE, within each step can be set TEST TIME Units of 100 ms range (0.1s ~ 9.9s).

Edit mode



Press the SEQ key to enter the AUTO SEQUENCE mode. Press up, down keys to select EDIT, the LCD display shows EDIT on left 5 digit LCD display, middle 5 digit LCD display FX, "FX" means to select the state F1-F9, press keypad key 1 ~ 9 to choose F1 ~ F9.

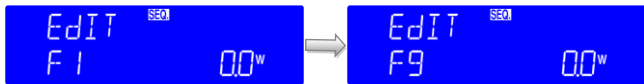

- Press Enter key, the LCD display shows FX-XX on left 5 digit LCD display, middle 5 digit LCD display STATE, right 5 digit LCD display setting 1~150, "FX" means to select the state F1-F9. "XX" means the test STEP01-16, setting state value. Press up and down keys or keypad to adjust setting.

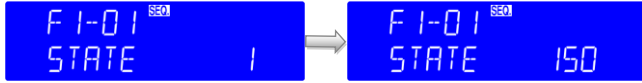

Test time setting

- Press ENTER to set TIME value, press up, down keys or KEYPAD to adjust settings, range from 100 ms~9999ms. Press Enter key or SAVE key to finish editing, if you do not save the settings, press the Exit key to leave edit mode.

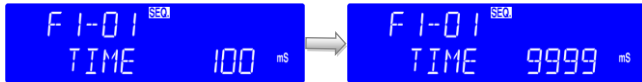

- Setting repeat (REPEAT TEST). Press up and down keys or keypad to adjust setting 0~9999. Press ENTER to save repeat value, or press Exit key to exit edit mode.

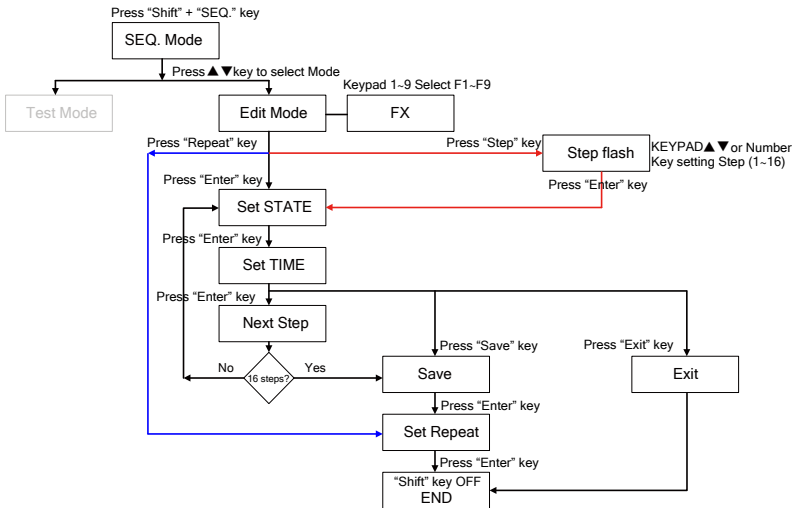
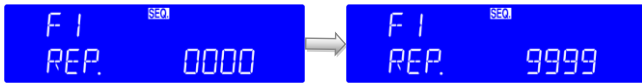

Store (Edit) mode operation flow chart

Test mode



- Press the SEQ key to enter the AUTO SEQUENCE mode. Press up, down keys to select TEST, the LCD display shows TEST on left 5 digit LCD display, middle 5 digit LCD display FX, "FX" means to select the state F1-F9, Press keypad key 1 ~ 9 choose F1 ~ F9. Press Enter key to enter the next automatic test mode.
- Test LCD will display "SXX", "XX" on behalf of the test of STEP. If the test result is NG, the LCD will show "NG" (flashing) and suspension of the test. This time users can test or Enter key to continue. Press Exit key to leave the test mode, test mode by the (STEP01 - TIME) then (SETP02 - TIME) until all the steps done or press EXIT to leave the test mode.
- If all the test steps are OK, the test result is passed, LCD displays "PASS". If any of the NG, the test result is FAIL and LCD displays "FAIL". If the buzzer is set to ON, when the test result is pass automatically, the buzzer will call out. If the test result is fail, buzzer will sound when the second call.
- When the test is completed, the user can press the Enter key again to test or Exit key to leave the test mode.

Example

Edit the 16 step test is completed. Press the TEST key, according to the order of S01 ~ S16 test is complete LCD display PASS.

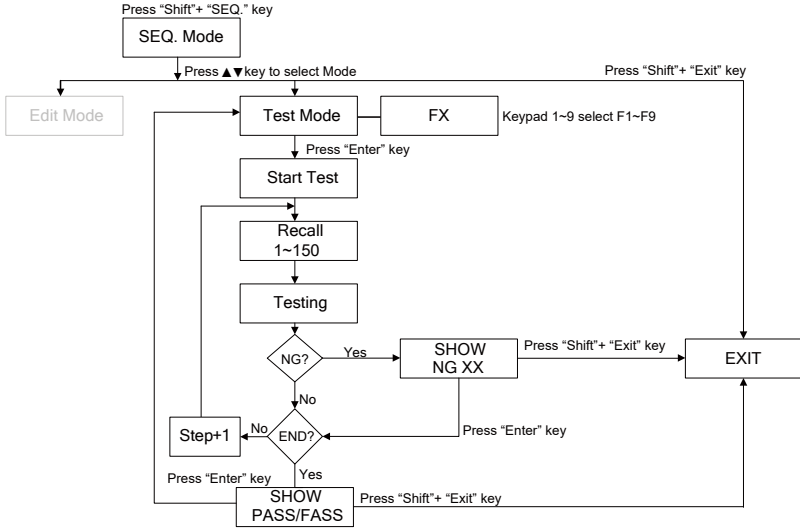

Test mode operation flow chart

Entry description



Rotary Knob and arrow Keys The rotary knob and arrow keys are used to increase or decrease the set values.

- Clockwise the rotary switch and up arrow key to increase the setting values.

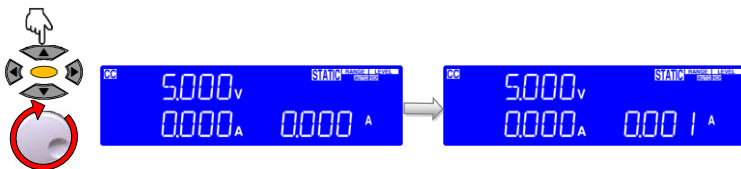

- Anti-clockwise and down arrow key operation of the rotary knob decreases the setting value.

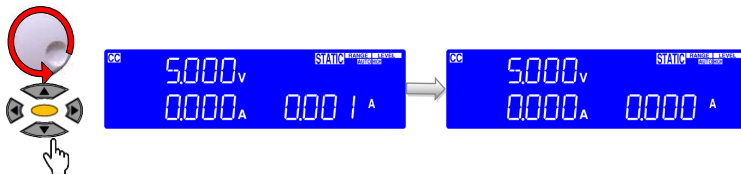

- **Keypad key:** When using the keypad, please enter the number, press the Enter key.

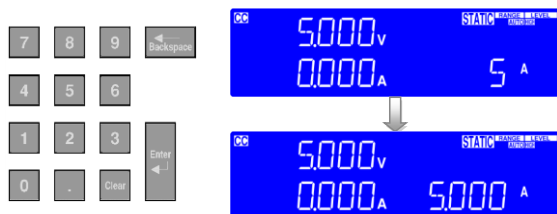

- Clear key: Press the Clear key to clear the input value.

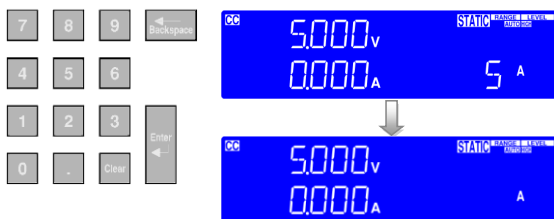

In CR mode, the up arrow key and clockwise operation of the rotary knob reduces the resistance.

In CR mode, the down arrow key and anti-clockwise operation of the rotary knob increases the resistance.

CONNECTION

Rear Panel	88
Connecting the I-monitor to an oscilloscope.....	92
Master/Slave Instructions.....	93

Rear Panel

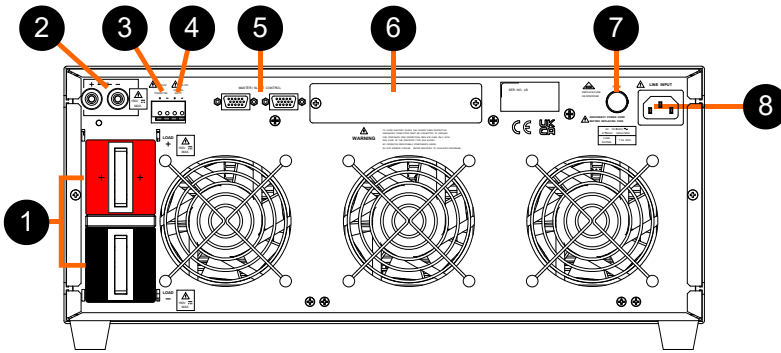

- 1 DC input terminal The positive (LOAD +) and negative (LOAD -) power input terminals are clearly marked. DO NOT confuse them with the smaller SENSE terminals.

Please ensure that the voltage and current rating of the DUT do not exceed the maximum rating of the PEL-5000G series load module being used. Please also check the output polarity of the DUT prior to connection and testing.

The negative load terminal should be connected to ground if testing a positive output power supply. This is normally achieved when the negative output of the power supply is grounded.

Similarly if a power supply with a negative output is to be tested then the positive load terminal should be grounded. This is normally achieved when the positive output of the power supply under test is grounded.

- 2 V-sense input terminal The V-sense terminals can be used to compensate for a voltage drop in the load lines between the power supply and the PEL-5000G

series electronic load. This is a useful feature useful when the load current is relatively high.

If remote sense is required, the V-sense terminals are connected to the appropriate positive and negative terminals of the power supply as shown in figure below. In the CONFIG menu, the V-sense function can be set to AUTO or ON.

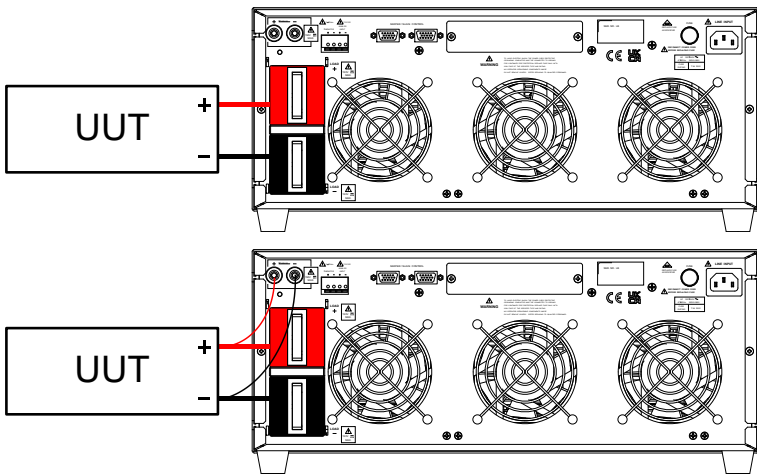

Typical connection of PEL-5000G series load module



Note

If V-sense is set to AUTO and the sense leads are connected to the DUT the losses need to be approx. before the display compensates for the voltage loss.

If V-sense is set to "ON" and the sense terminals are connected to the DUT the load will check and compensate for all voltage drops.

The maximum voltage sense compensation is the same as the rating of the PEL-5006G-150-600 electronic load. For example the PEL-5006G-150-600 is capable of sinking current at up to 150Vdc. Therefore the maximum V-sense

is also 150Vdc.

3 I-monitor terminal

The I-monitor is provided as a Terminal. It is designed to enable the user to monitor the electronic load's input current or short current. The I-monitor's signal is 0V to 10V. This signal is proportional to the full scale current that the particular electronic load is capable of.

For example, PEL-5006G-150-600: $I_{max} = 600A$ therefore I-monitor 10V = 600A so 1V = 60A.

Please refer to the specification on page 223 for the maximum current that each PEL-5000G series Load is capable of.

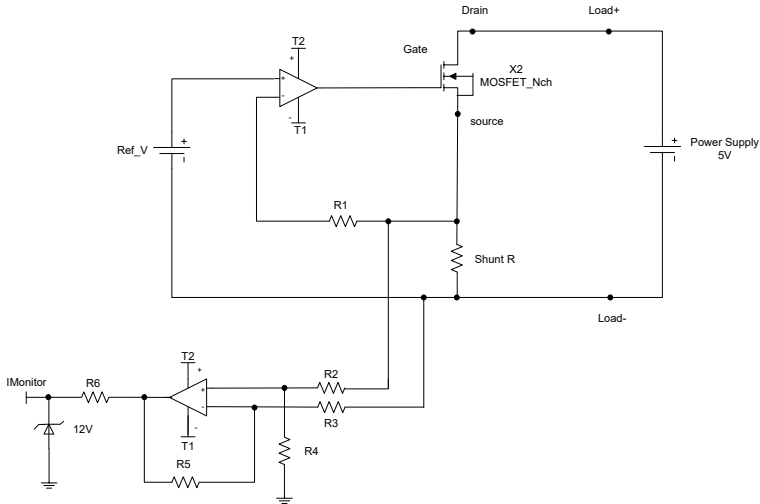

An equivalent circuit in terms of the current monitor



Caution

The current monitor of this unit is NOT isolated. Please be careful when you connect an oscilloscope. Improper connections are likely to cause damage. Please follow the connection rule on page 92.

4 Analog programming input

The Electronic Load has an analog programming input on the rear panel of the mainframe. The analogue programming input

enables the load module to track and load according to an external 0-10V signal.

The analog programming input is configured as a Terminal on the mainframe's rear panel.

The analogue programming input operates in CC or CP modes only. The PEL-5000G series Load will attempt to load proportionally according to the signal and the load module's maximum current or power range. For example: PEL-5006G-150-600: $I_{max} = 600A$ and $P_{max} = 6000W$

So in CC mode if analogue programming input is 5V = 300A load setting (Range II) or in CP mode if analogue programming input is 1V = 600W load setting (Range II)

The analog programming signal can act alone or it can be summed with the programmed value set via the front panel or the optional computer interface (GPIB, RS-232, USB, or LAN) or the front panel.

Analog programming example

The figure below shows the result of an analog programming signal at 4 Vac, 500Hz when it is summed with a 240A programmed setting in CC mode of PEL-5006G-150-600 Load.

- 5 Parallel operation control (please refer to page 93)
- 6 Interface card socket (please refer to page 100)
- 7 Fuse (Please refer to page 220)
- 8 AC line input (Please refer to page 98)

Connecting the I-monitor to an oscilloscope

When you connect this product to an oscilloscope, please ensure the correct polarities of the connecting probes as shown in fig below

(Correct)
Connections to
an oscilloscope

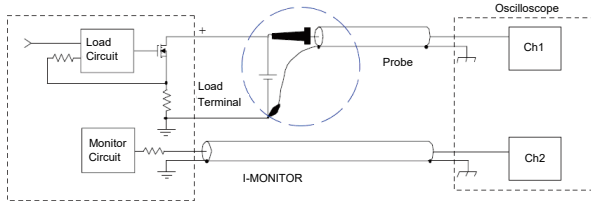

(Wrong)
Connections to
an oscilloscope

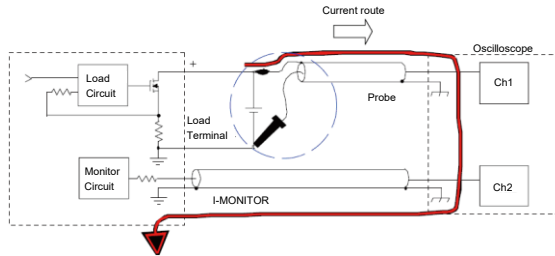

If the probes connection is reversed as shown above, a large current would flow through the probe and the internal circuitry of the oscilloscope is likely to be damaged.

Master/Slave Instructions

PEL-5000G series "MASTER / SLAVE" parallel function. 1 master and 7 slaves can be connected.

- Setting method
1. Press the System key to set the CONTROL MODE to select ALONE, MASTER or SLAVE1 ~ 7.
 2. Press the Enter key to set. When Power off data will not be lost and this parameter is saved. Master will automatically detect whether there is slave machine, if there is no slave, the machine will run "ALONE Mode". if there is slave, the machine will run "MASTER Mode".
 3. Master machine measuring current and power meter is to show the total current and total power (Master + Slave), the voltage meter is displayed by the master machine, the slave machine voltage meter position will display "SL1" ~ "SL7".

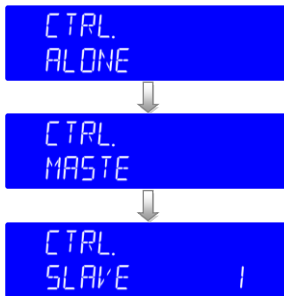

The following procedure should be followed before applying power on.

Master/Slave mains:

Step1. Turn on (O) the Slave POWER switch.

Step2. Turn on (O) the Master POWER switch.

The following procedure should be followed before applying power off.

Master/Slave mains:

Step1. Turn off (I) the Master POWER switch.

Step2. Turn off (I) the Slave POWER switch.

Parallel method

Use HD-DSUB 15pin 1: 1 Cable to connect the MASTER and SLAVE rear panel, HD-DSUB 15pin connector (connect the upper and lower Connectors)



Caution

Do not use VGA Cable, because of internal pin4 ~ 8, 11 and chassis short circuit.



Wiring requirements

Master/Slave, It requires wiring as follows:

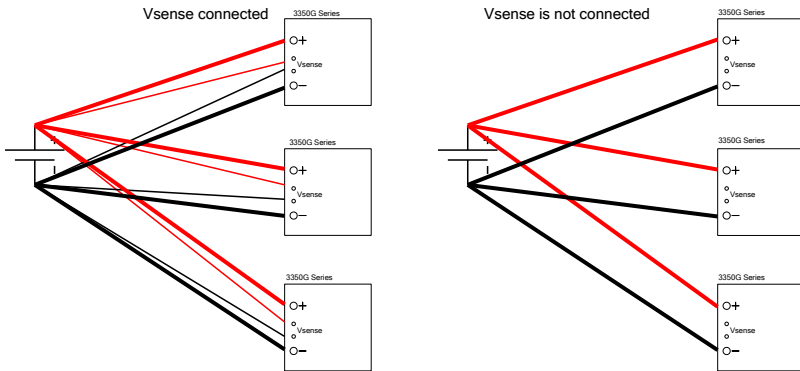

Manual operation (PEL-5006G-150-600 MASTER/SLAVE model the following is example)









Preset setting: CC/CR/CV/CP Mode as Figure,

CC: 64A = Master 32A + Slave 32A

CR: 7500Ω = Master // Slave = 15000Ω // 15000Ω,

CV: 100V = Master 100V = Slave = 100V,

CP: 1000W = Master 500W + Slave 500W.

CC Set 30A	Master Display	
	Slave Display	
CR Set 7500.0Ω	Master Display	
	Slave Display	
CV Set 100V	Master Display	
	Slave Display	
CP Set 1000W	Master Display	
	Slave Display	



Note

Master Mode operation except CC / CR / CV / CP Mode, The following functions will be disabled.

- Config function BATT type 1~N Disable
- CC + CURRENT LIMIT, CP+CV Disable.
- Recall/Store Disable.
- Auto Seq. Disable.
- Short, OCP, OPP Disable.
- External I/O Disable

Remote operating Master Mode can use the command as follows

Setting preset numeric command	Remark
MODE{SP}{CC CR CV CP}{; NL}	
RISE{SP}{NR2}{; NL}	A/us
FALL{SP}{NR2}{; NL}	A/us
PERD:{HIGH LOW}{SP}{NR2}{; NL}	ms
LDONV{SP}{NR2}{; NL}	
LDOFFV{SP}{NR2}{; NL}	
CC CURR:{HIGH LOW}{SP}{NR2}{; NL}	
CP:{HIGH LOW}{SP}{NR2}{; NL}	
CR RES:{HIGH LOW}{SP}{NR2}{; NL}	
CV VOLT:{HIGH LOW}{SP}{NR2}{; NL}	
SENS{SP}{ON OFF AUTO 1 0}{; NL}	0: OFF/AUTO, 1: ON
LEV{SP}{LOW HIGH 0 1}{; NL}	
DYN{SP}{ON OFF 1 0}{; NL}	
LOAD{SP}{ON OFF 1 0}{; NL}	
MEAS:Curr?{; NL}	
MEAS:VOLT?{; NL}	
MEAS:POW?{; NL}	
REMOTE {; NL}	RS232/USB/LAN command
LOCAL{; NL}	RS232/USB/LAN command

INSTALLATION

The PEL-5000G series high power load was carefully inspected before shipment. If instrument damage has occurred during transport, please inform GW Instek's sales and service office or representative.

Your PEL-5000G series high power load was shipped with a power cord for the type of Terminal blocks used at your location. If the appropriated cord was not included, please contact your nearest GW Instek sales office to obtain the correct cord. Refer to “check line voltage” to check the line voltage is 100V~240Vac.

Check line voltage	98
Grounding requirements.....	98
Power up	99
Connection to the load input terminal	99
Interface Option	100
GPIB & RS232 Interface.....	100
RS232 interface.....	101
GPIB interface.....	101
USB interface	102
LAN interface	102
I/O connection	103
Load current slew rate setting.....	105
Load wire inductance	107

Check line voltage

Background The PEL-5000G series high power load can operation with 100Vac ~ 240Vac input as indicated on the label on the rear panel.

Make sure that the factory check mark corresponds to your nominal line voltage. Skip this procedure if the label is corrected marked.

- Installation**
1. With the PEL-5000G series load power OFF, disconnect the power cord.
 2. Refer the drawing on the rear panel of PEL-5000G series high power load as figure below.

**PEL-5000G series
AC Input
Connection**

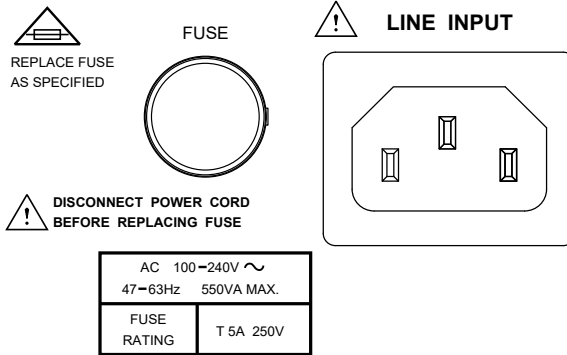

Grounding requirements



1. It is requested to use the 3 pin plug connector only for PEL-5000G series mainframe to out of danger when electric leakage. And the complete and proper grounded is necessary.
2. The PEL-5000G series high power load is equipped with three conductor cable which plugs in an appropriate receptacle to ground the instrument's cover.

Power up

The following procedure should be followed before applying mains power.

-
- | | |
|-----------|--|
| Procedure | <ol style="list-style-type: none">1. Turn off (O) the POWER switch.2. Check that the power cord is corrected.3. Check that nothing is connected to the DC INPUT on the rear panels.4. Turn on POWER switch. |
|-----------|--|
-

Connection to the load input terminal

Connection procedure of the load input terminal on the rear panel

-
- | | |
|-----------|---|
| Procedure | <ol style="list-style-type: none">1. Turn off POWER switch.2. Check that the output of the equipment under test is off.3. Connect the load wire to the load input terminal on the rear panel.4. Check the polarity of the connection and connect the load wire to the output terminal of the equipment under test. |
|-----------|---|
-



Note

Avoid equipment damaged, don't input the DC voltage standard output to the DC Load input terminal, if calibration voltage meter required, please input the DC voltage standard to the Vsense input.

Interface Option

GPIB & RS232 Interface

Procedure

1. GPIB + RS232 interface is on the rear panel of PEL-5000G series mainframe for application GPIB or RS232.
 2. GPIB and RS232 interface can only be used at the same time, to change the interface must reboot unit.
 3. GPIB connection with three important limitations as described below:
 - The maximum number of devices including the controller is no more than 15.
 - The maximum length of all cable is no more than 2 meters times the number of devices connected together, up to 20 meters Maximum.
 - RS232 female block connections on the back panel, the connecting device and the computer RS232 port to one-way connection. For details, please refer to page 112
 4. The figure below shows the RS232 connector (Female) on the rear panel connects PEL-5000G series mainframe to RS232 port of computer in one by one configuration .The RS232 BAUD-RATE can be set in the front panel, it will be lit the GPIB Address when press the "System" button. Press it again, it will be lit the BAUD-RATE.
-

PEL-5000G Series GPIB & RS232 interface



RS232 interface

The figure below shows the RS232 connector (Female) on the rear panel connects PEL-5000G series mainframe to RS232 port of computer in one by one configuration. The RS232 BAUD-RATE can be set in the front panel, it will be lit the GPIB address when press the “System” button. Press it again, it will be lit the BAUD-RATE.

PEL-5000G Series RS232 interface



GPIB interface

Connection procedure of the load input terminal on the rear panel

- The maximum number of devices including the controller is no more than 15.
 - The maximum length of all cable is no more than 2 meters times the Number of devices connected together, up to 20 meters maximum.
-

PEL-5000G Series GPIB interface



USB interface

The figure below shows the USB connector in the rear panel of PEL-5000G series mainframe.

Please refer to appendix “PEL-5000G series USB Instruction” on page 245.

PEL-5000G USB interface



LAN interface

The figure below shows the LAN connector in the rear panel of PEL-5000G series mainframe.

Please refer to appendix “PEL-5000G series LAN Instruction” on page 247.

PEL-5000G LAN
interface



9923 interface (optional)

The figure below shows the 9923 connector in the rear panel of 3350G series mainframe. Please refer to page 204.

PEL-5000G series
9923 interface



I/O connection

PEL-5000G series I/O Interface with Vsense, Analog Programming Input, Imonitor. For instructions about I/O, please refer to page 88.

PEL-5000G series
I/O interface

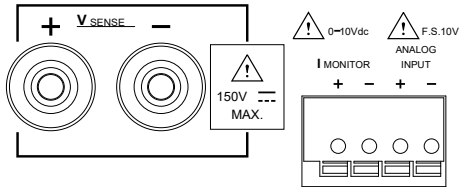

Load current slew rate setting

Connection procedure of the load input terminal on the rear panel

What is the load current slew rate during load current level change, power supply turn ON/OFF switch between ON, and OFF? The PEL-5000G series Electronic load provides all of the above load current slew rate in controllable condition, the rise and fall current slew rate can be set independently from front panel operation or remote programming.

The slew rate determines a rate at which the current changes to a new programmed value. The slew rate can be set at the front panel or via GPIB on the rear panel of PEL-5000G series high power load.

The rise and fall slew rate can be independently programmed from 384mA/usec to 24A/usec (PEL-5006G-150-600 Load) in the 600A current range and from 38.4mA/usec to 2.4A/usec in the 60A current range. This allows a independent controlled transition from Low load current level to High load current level (rise current slew rate) or from High load current level to Low load current level(fall current slew rate) to minimize induced voltage drops on the inductive wiring, or to control induced transients on the est. device (power supply transient response testing).

This controllable load current slew rate feature also can eliminate the overload current Phenomenon and emulate the actual load current slew rate at turn ON the power supply under test. The figure below shows the load current slew rate is according to the power supply's output voltage, load level setting and

Load ON/OFF switch. So, you could do all items of Power Supply testing task by using constant current mode only, it can significantly improve the testing quality and process as well as efficiency.

There are two load current range in PEL-5000G series Load, Range I and Range II, the slew rate of range I, range II, RISE/FALL slew rate are listed in chapter of specifications

The relationship of load current load ON/OFF, load level and output voltage of DC power supply at turn ON

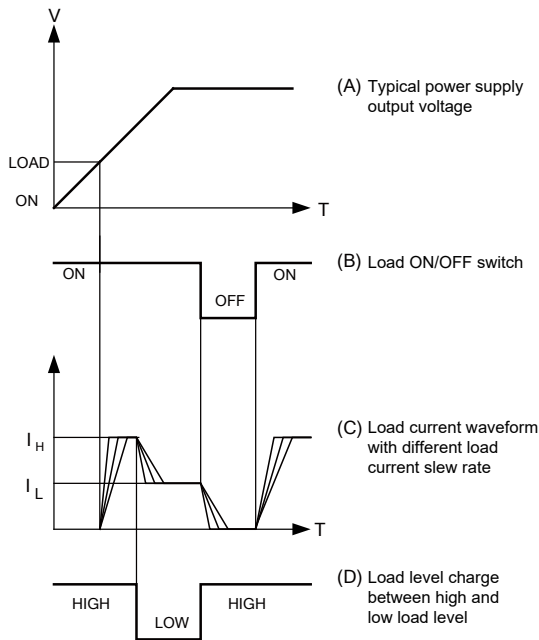

Load wire inductance

Connection procedure of the load input terminal on the rear panel

The load wiring has an inductance (L). When the current (I) varies in short time period, It generates a large voltage at both ends of the wiring cable. This voltage applies to all of the load input terminals of the PEL-5000G series when the impedance of the EUT is relatively small. The voltage generated by the load wire inductance (L) and the current variation (I) is expressed using the following equation.

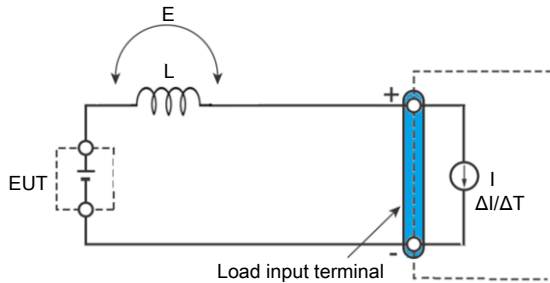

$$E = L \times (\Delta I / \Delta T)$$

E: Voltage generated by the wire inductance

L: Load wire inductance

ΔI : Amount of Current variation

ΔT : Variation period of current

In general, the wire inductance can be measured approximately $1 \mu\text{H}$ per 1 meter. If the 10 meters of Load wires is connected between the EUT and the electronic load (PEL-5000G Series) with the current variation of $2 \text{ A}/\mu\text{s}$, the voltage generated by the wire inductance Will be 20 V.

The negative polarity of the load input terminal is the reference potential of the external control signal, Therefore, the device connected to the external control terminal may get malfunctioned.

When operating under the constant voltage (CV) mode or constant resistance (CR) mode or constant power (CP), the load current is varied by the voltage at the load input terminal, so the operation can be affected easily by the generated voltage.

The wiring to the EUT should be twisted and the shortest as possible.

If the load wire is long or has a large loop, the wire inductance is increased. Consequently, the current variation that results when switching occurs will cause a large voltage drop.

When the value of instantaneous voltage drops under the minimum operating voltage depends on the generated voltage at the load input terminal, the response of recovery will be extensively delayed.

In such event, the electronic load (PEL-5000G Series) may generate unstable oscillation. In such condition, the input voltage may exceed the maximum input voltage and cause damage to the PEL-5000G series.

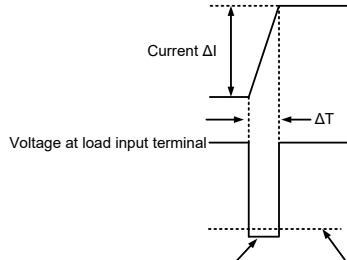

When the voltage drops under minimum operating voltage, the electronic load may generate unstable oscillation.

Waveform example:
Generate unstable oscillation

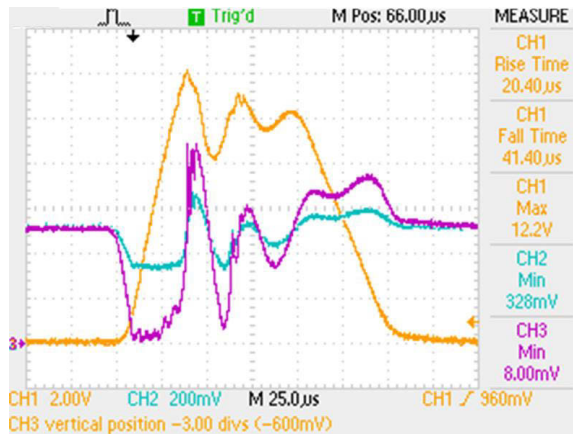

CH1= Imonitor

CH2=Power Supply output Voltage (x10)

CH3= LOAD Input Voltage (x10)

You must be careful especially when the slew rate setting is high or switching is performed using large currents through parallel operation.

To prevent problems, connect the PEL-5000G series and the equipment under test using the shortest twisted wire possible to keep the voltage caused by inductance between the minimum operating voltage and the maximum input voltage range or set a low slew rate.

If the high-speed response operation is not required, decrease the slew rate setting.

In such settings, the value of DI / DT will be decreased, accordingly the generated voltage will be reduced even the inductance of load wiring can't be reduced.

In the case of DC operation also, the phase delay of the current may cause instability in the PEL-5000G series control inducing oscillation. In this case also, connect the PEL-5000G series and the equipment under test using the shortest twisted wire possible.

If only DC operation is required, a capacitor and a resistor may be connected to the load input terminal as shown in figure below to alleviate oscillation. In this case, use the capacitor within its allowable ripple current.

Length of wiring

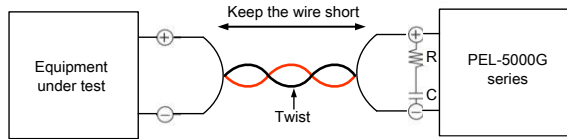

Example: $R=10\Omega$
 $C=100\mu F$

REMOTE CONTROL

The rear panel remote control interface of PEL-5000G Series mainframe is designed to connect PC or NOTEBOOK PC with remote control interface, the NOTEBOOK PC acts as a remote controller of PEL-5000G Series Electronic Load.

This feature can be used as an automatic load/cross load regulation and centering voltage testing for a switching power supply or an rechargeable battery charge/discharge characteristic testing. The function capability of rear panel remote control interface not only can set the load level and load status, but also can read back the load voltage and load current.



Note

When use USB/LAN interface controls the PEL-5000G series, the PEL-5000G series will convert the USB/LAN interface to RS232 interface.

Configure RS232C	112
Communication Interface programming command list.....	114
SIMPLE TYPE FORMAT	114
System command	119
Measure command.....	119
Auto sequence command	120
COMPLEX TYPE FORMAT	121
Command Syntax	127
The description of abbreviation	127
Communication Interface programming command syntax description.....	127
Command List	129

Configure RS232C

The following RS232 commands are same as GPIB commands. The RS232 protocol in PEL-5000G Series mainframe is listing below:

RS232C Configuration	Baud Rate	9600~115200bps
	Stop Bit	1 bit
	Data Bit	8 bits
	Parity	None
	Handshaking	Hardware (RTS/CTS)

The RS232 Interface connector of PEL-5000G Series rear panel

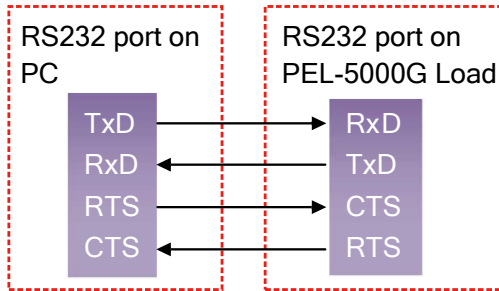

Inside of PEL-5000G series Mainframe

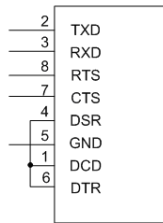

Pin Assignment

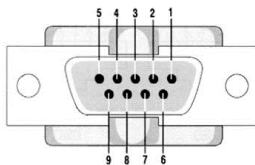

PIN	Abbreviation	Description
Pin1	CD	Carrier Detect
Pin2	RXD	Receive
Pin3	TXD	Transmit
Pin4	DTR	Data Terminal Ready
Pin5	GND	Ground
Pin6	DSR	Data Set Ready
Pin7	RTS	Request To Send
Pin8	CTS	Clear To Send
Pin9	RI	Ring Indicator

Communication Interface programming command list

SIMPLE TYPE FORMAT

Communication interface programming setting command summary

Setting preset numeric command	Remark
RISE{SP}{NR2}{; NL}	A/us
FALL{SP}{; NL}	A/us
PERD:{HIGH LOW}{SP}{NR2}{; NL}	
LDONV{SP}{NR2}{; NL}	
LDOFFV{SP}{NR2}{; NL}	
CC CURR:{HIGH LOW}{SP}{NR2}{; NL}	
CP:{HIGH LOW}{SP}{NR2}{; NL}	
CR RES:{HIGH LOW}{SP}{NR2}{; NL}	
CV VOLT:{HIGH LOW}{SP}{NR2}{; NL}	
TCONFIG{SP}{NORMAL OCP OPP SHORT} {; NL}	
OCP:START{SP}{NR2}{; NL}	Set OCP start current (Istart), unit: A
OCP:STEP{SP}{NR2}{; NL}	Set OCP step current (Istep), unit: A
OCP:STOP{SP}{NR2}{; NL}	Set OCP stop current (Istop), unit: A
VTH{SP}{NR2}{; NL}	
OPP:START{SP}{NR2}{; NL}	
OPP:STEP{SP}{NR2}{; NL}	
OPP:STOP{SP}{NR2}{; NL}	
STIME{SP}{NR2}{; NL}	
BATT:UVP{SP}{NR2}{; NL}	unit: V
BATT:TIME{SP}{n}{; NL}	0~99999, 0=OFF
BATT:AH{SP}{NR2}{NL}	0, 0.1~19999.9, 0=OFF
BATT:WH{SP}{NR2}{NL}	0, 0.1~19999.9, 0=OFF
BATT:TEST{SP}{ON OFF}	Test ON/OFF
SURGE:SURI{NR2}{; NL}	

SURGE:NORI{NR2}{; NL}	
SURGE:TIME{NR2}{; NL}	Surge time:10~1000ms
SURGE:STEP{SP}{n}{; NL}	n=1~5
SURGE{ON OFF}{; NL}	ON: Run surge, OFF: Stop
BMS{SP}{ON OFF 1 0}{; NL}	Enable/disable BMS test function ON: Enable, OFF: Disable
BMS:STIME{SP}{NR2}{; NL}	Set BMS short time, Unit: ms, 0.05~10ms
SHORT:ITH{SP}{NR2}{; NL}	Set BMS short ITH, Unit: A
OCP:ITH{SP}{NR2}{; NL}	Set BMS OCP ITH, Unit: A
OCP:TSTEP{SP}{NR2}{; NL}	Set BMS OCP Tstep, Unit: ms, 0.05 ~ 10ms/ 11~1000ms
AVG{SP}{n}{; NL}	
TURBO{SP}{ON OFF}{; NL}	
EXT:AIN{SP}{ON OFF}{; NL}	
SEQLD:TOTSTEP{SP}{n}{; NL}	SET STEP, n = 2~16
SEQLD:TIME{n}{SP}{NR1}{; NL}	SETΔTIME = 0.02 ~ 999000ms, NIT: ms, n = 0~15
SEQLD:CC{n}{SP}{NR2}{; NL}	SET CURRENT, UNIT:A, n = 0~15
SEQLD:CP{n}{SP}{NR2}{; NL}	SET POWER, UNIT: W, n = 0~15

Communication interface programming query command summary

Query preset numeric command	Return
RISE{?}{; NL}	###.####
FALL{?}{; NL}	###.####
PERD:{HIGH LOW}{?}{; NL}	###.####
LDONV{?}{; NL}	###.####
LDOFFV{?}{; NL}	###.####
CC CURR:{HIGH LOW}{?}{; NL}	###.####
CP:{HIGH LOW}{?}{; NL}	###.####
CR RES:{HIGH LOW}{?}{; NL}	###.####
CV VOLT:{HIGH LOW}{?}{; NL}	###.####
TCONFIG{?}{; NL}	1: NORMAL 3: OPP 2: OCP 4: SHORT
OCP:START{?}{; NL}	###.####

OCP:STEP{?}; NL}	###.####
OCP:STOP{?}; NL}	###.####
VTH{?}; NL}	###.####
OPP:START{?}; NL}	###.####
OPP:STEP{?}; NL}	###.####
OPP:STOP{?}; NL}	###.####
STIME{?}; NL}	###.####
OCP{?}; NL}	###.####
OPP{?}; NL}	###.####
BATT:RAH{?}; NL}	Read BATT test result AH
BATT:RWH{?}; NL}	Read BATT test result WH
BATT:RTIME{?}; NL}	Read BATT test result TIME
BATT:RVOLT{?}; NL}	Read BATT test result VOLTAGE
BATT:CURR{?}; NL}	
PROT:TIME{?}; NL}	Read BMS Short/OCP protect time, Unit: ms
AVG{?}; NL}	
SEQLD:TOTSTEP{?}; NL}	
SEQLD:TIME{n}{?}; NL}	n = 0~15
SEQLD:CC{n}{?}; NL}	n = 0~15
SEQLD:CP{n}{?}; NL}	n = 0~15

Communication interface programming limit command summary

Limit command	Remark
IH IL{SP}{NR2}; NL}	
IH IL{?}; NL}	
WH WL{SP}{NR2}; NL}	
WH WL{?}; NL}	###.####
VH VL{SP}{NR2}; NL}	
VH VL{?}; NL}	###.####
SVH SVL{SP}{NR2}; NL}	
SVH SVL{?}; NL}	###.####
LIM:ADDCV:VOLTage{SP}{NR2}; NL}	
LIM:ADDCV:VOLTage{?}; NL}	###.####
LIM:ADDCV:CURR{SP}{NR2}; NL}	
LIM:ADDCV:CURR{?}; NL}	###.####
LIM:ADDCV:POW{SP}{NR2}; NL}	

LIM:ADDCV:POW{?}; NL}	###.####
LIM:ADDCV:{SP}{ON OFF}; NL}	

State command summary

State command	Remark
LOAD{SP}{ON OFF 1 0}{; NL}	
LOAD{?}{; NL}	0: OFF, 1: ON
MODE{SP}{CC CR CV CP}{; NL}	
MODE{?}{; NL}	0: CC, 1: CR, 2: CV, 3: CP
SHOR{SP}{ON OFF 1 0}{; NL}	
SHOR{?}{; NL}	0: OFF, 1: ON
PRES{SP}{ON OFF 1 0}{; NL}	
PRES{?}{; NL}	0: OFF, 1: ON
SENSe{SP}{ON OFF AUTO 1 0}{; NL}	
SENSe{?}{; NL}	0: OFF/AUTO, 1:ON
LEV{SP}{LOW HIGH 0 1}{; NL}	
LEV{?}{; NL}	0: LOW, 1: HIGH
DYN{SP}{ON OFF 1 0}{; NL}	
DYN{?}{; NL}	0: OFF, 1:ON
CLR{; NL}	
NG{?}{; NL}	0: GO, 1: NG
PROT{?}{; NL}	
CC{SP}{AUTO R2}{; NL}	
NGENABLE{SP}{ON OFF}{; NL}	
POLAR{SP}{POS NEG}{; NL}	
START{; NL}	
STOP{; NL}	
TESTING{?}{; NL}	0: TEST END, 1: TESTING
BATT:TEST{SP}{ON OFF}{; NL}	ON: Start test, OFF: Stop test
SEQLD:TYPE{SP}{CC CP}{; NL}	Set CC or CP mode
SEQLD:TRIG{SP}{ON}{; NL}	Trigger change CC/CP value
SEQLD:TEST{SP}{ON OFF}{; NL}	Set start or stop test

System command

System command summary

Command	Note	Return
RECALL{SP}{m}{; NL}	m=1~150, m: STATE	
STORE{SP}{m}{; NL}	m=1~150 m: STATE	
REMOTE{; NL}	RS232/USB/LAN command	
LOCAL{; NL}	RS232/USB/LAN command	
NAME{?}{; NL}		"XXXXX"
*RST{; NL}		

Measure command

Measure command summary

Command	Return
MEAS:CURR{?}{; NL}	###.####
MEAS:VOLT{?}{; NL}	###.####
MEAS:POW{?}{; NL}	###.####
MEAS:VC{?}{; NL}	###.####,###.####

Remark	<ol style="list-style-type: none"> 1. Current engineering unit: A 2. Voltage engineering unit: V 3. Resistance engineering unit: Ω 4. Period engineering unit: mS 5. Slew-rate engineering unit: A/μS 6. Power engineering unit: W
--------	---

Auto sequence command

Auto sequence command list

Auto sequence setting command	Note	Return
FILE{SP}{n}{; NL}	n = 1~9	1 ~ 9
FILE{?}{; NL}	n = 1~9	1 ~ 9
STEP{SP}{n}{; NL}	n = 1~16	1 ~ 16
STEP{?}{; NL}	n = 1~16	1 ~ 16
TOTSTEP{SP}{n}{; NL}	Total step n = 1~16	1 ~ 16
TOTSTEP{?}{; NL}	Total step n = 1~16	1 ~ 16
SB{SP}{m}{; NL}	m = 1~150, m: STATE	
SB{?}{; NL}	m = 1~150, m: STATE	
TIME{SP}{NR2}{; NL}	100 ~ 9999(ms)	100 ~ 9999(ms)
SAVE{; NL}	Save "File n" data	
REPEAT{SP}{n}{; NL}	n = 0~9999	0 ~ 9999
REPEAT{?}{; NL}	n = 0~9999	0 ~ 9999
RUN{SP}{F}{n}{; NL}	n = 1~9	AUTO REPLY "PASS" or FAIL: XX"(XX=NG STEP)

COMPLEX TYPE FORMAT

Communication interface programming setting command summary

Setting command summary	Remark
[PRESet:]RISE{SP}{NR2}{; NL}	A/us
[PRESet:]FALL{SP}{; NL}	A/us
[PRESet:]PERD:{HIGH LOW}{SP}{NR2}{; NL}	
[PRESet:]LDONv{SP}{NR2}{; NL}	
[PRESet:]LDOFfv{SP}{NR2}{; NL}	
[PRESet:]CC CURR:{HIGH LOW}{SP}{NR2}{; NL}	
[PRESet:]CP:{HIGH LOW}{SP}{NR2}{; NL}	
[PRESet:]CR RES:{HIGH LOW}{SP}{NR2}{; NL}	
[PRESet:]CV VOLT:{HIGH LOW}{SP}{NR2}{; NL}	
[PRESet:]TCONFIG{SP}{NORMAL OCP OPP SHORT}{; NL}	
[PRESet:]OCP:START{SP}{NR2}{; NL}	Set OCP start current (Istart), unit: A
[PRESet:]OCP:STEP{SP}{NR2}{; NL}	Set OCP step current (Istep), unit: A
[PRESet:]OCP:STOP{SP}{NR2}{; NL}	Set OCP stop current (Istop), unit: A
[PRESet:]VTH{SP}{NR2}{; NL}	
[PRESet:]OPP:START{SP}{NR2}{; NL}	
[PRESet:]OPP:STEP{SP}{NR2}{; NL}	
[PRESet:]OPP:STOP{SP}{NR2}{; NL}	
[PRESet:]STIME{SP}{NR2}{; NL}	
[PRESet:]BATT:UVP{SP}{NR2}{; NL}	unit: V
[PRESet:]BATT:TIME{SP}{n}{; NL}	0~99999, 0=OFF
[PRESet:]BATT:AH{SP}{n}{; NL}	0, 0.1~19999.9, 0=OFF
[PRESet:]BATT:WH{SP}{n}{; NL}	0, 0.1~19999.9, 0=OFF
[PRESet:]BATT:TEST{SP}{ON OFF}	TEST ON/OFF
[PRESet:]SURGE:SURI{NR2}{; NL}	
[PRESet:]SURGE:NORI{NR2}{; NL}	
[PRESet:]SURGE:TIME{NR2}{; NL}	Surge time: 10 ~ 1000ms

[PRESet:]SURGE:STEP{SP}{n}{; NL}	n=1~5
[PRESet:]SURGE{ON OFF}{; NL}	ON: Run surge, OFF: Stop
[PRESet:]BMS{SP}{ON OFF 1 0}{; NL}	Enable/disable BMS test function ON: enable, OFF: Disable
[PRESet:]BMS:STIME{SP}{NR2}{; NL}	Set BMS short time, Unit: ms, 0.05~10ms
[PRESet:]SHORT:ITH{SP}{NR2}{; NL}	Set BMS short ITH, Unit: A
[PRESet:]OCP:ITH{SP}{NR2}{; NL}	Set BMS OCP ITH, Unit: A
[PRESet:]OCP:TSTEP{SP}{NR2}{; NL}	SET BMS OCP Tstep, Unit: ms, 0.05 ~ 10ms/ 11~1000ms
[PRESet:]LIMit:ADDCV:VOLT{SP}{NR2}{; NL}	
[PRESet:]LIMit:ADDCV{SP}{ON OFF}{; NL}	
[PRESet:]AVG{SP}{n}{; NL}	
[PRESet:]TURBO{SP}{ON OFF}{; NL}	
[PRESet:]EXT:AIn{SP}{ON OFF}{; NL}	
[PRESet:]SEQLD:TOTSTEP{SP}{n}{; NL}	Set step, n = 2 ~ 16
[PRESet:]SEQLD:TIME{n}{SP}{NR1}{; NL}	Set ΔTIME = 0.02 ~ 999000ms, Unit: ms, n = 0 ~ 15
[PRESet:]SEQLD:CC{n}{SP}{NR2}{; NL}	Set current, Unit: A, n = 0~15
[PRESet:]SEQLD:CP{n}{SP}{NR2}{; NL}	Set power, Unit: W, n = 0~15

Communication Interface programming query command summary

Query command summary	Return
[PRESet:]RISE{?}{; NL}	###.####
[PRESet:]FALL{?}{; NL}	###.####
[PRESet:]PERD:{HIGH LOW}{?}{; NL}	###.####
[PRESet:]LDONv{?}{; NL}	###.####
[PRESet:]LDOfv{?}{; NL}	###.####
[PRESet:]CC CURR:{HIGH LOW}{?}{; NL}	###.####
[PRESet:]CP:{HIGH LOW}{?}{; NL}	###.####

[PRESet:]CR RES:{HIGH LOW}{?}; NL}	###.####
[PRESet:]CV VOLT:{HIGH LOW}{?}; NL}	###.####
[PRESet:]TCONFIG{?}; NL}	1: NORMAL, 2: OCP 3: OPP, 4: SHORT
[PRESet:]OCP:START{?}; NL}	###.####
[PRESet:]OCP:STEP{?}; NL}	###.####
[PRESet:]OCP:STOP{?}; NL}	###.####
[PRESet:]VTH{?}; NL}	###.####
[PRESet:]OPP:START{?}; NL}	###.####
[PRESet:]OPP:STEP{?}; NL}	###.####
[PRESet:]OPP:STOP{?}; NL}	###.####
[PRESet:]STIME{?}; NL}	###.####
[PRESet:]OCP{?}	###.####
[PRESet:]OPP{?}	###.####
[PRESet:]BATT:RAH{?}; NL}	Read BATT test result AH
[PRESet:]BATT:RWH{?}; NL}	Read BATT test result WH
[PRESet:]BATT:RTIME{?}; NL}	Read BATT test result time
[PRESet:]BATT:RVOLT{?}; NL}	Read BATT test result voltage
[PRESet:]PROT:TIME{?}; NL}	Read BMS short/OCP protect time, Unit: ms
[PRESet:]AVG{?}; NL}	
[PRESet:]SEQLD:TOTSTEP{?}; NL}	
[PRESet:]SEQLD:TIME{n}{?}; NL}	n = 0 ~ 15
[PRESet:]SEQLD:CC{n}{?}; NL}	n = 0 ~ 15
[PRESet:]SEQLD:CP{n}{?}; NL}	n = 0 ~ 15

Communication Interface programming limit command summary

Limit command	Return
[LIMit:]IH IL{SP}{NR2}; NL}	
[LIMit:]IH IL{?}; NL}	
[LIMit:]WH WL{SP}{NR2}; NL}	
[LIMit:]WH WL{?}; NL}	###.####
[LIMit:]VH VL{SP}{NR2}; NL}	
[LIMit:]VH VL{?}; NL}	###.####
[LIMit:]SVH SVL{SP}{NR2}; NL}	
[LIMit:]SVH SVL{?}; NL}	###.####

[LIMit:]ADDCV:VOLTage{SP}{NR2}{; NL}	
[LIMit:]ADDCV:VOLTage{?}{; NL}	###.####
[LIMit:]ADDCV:CURR{SP}{NR2}{; NL}	
[LIMit:]ADDCV:CURR{?}{; NL}	###.####
[LIMit:]ADDCV:POW{SP}{NR2}{; NL}	
[LIMit:]ADDCV:POW{?}{; NL}	###.####
[LIMit:]ADDCV:{SP}{ON OFF}{; NL}	

State command summary

State command	Remark
[STATe:]LOAD{SP}{ON OFF}{; NL}	
[STATe:]LOAD{?}{; NL}	0: OFF, 1: ON
[STATe:]MODE{SP}{CC CR CV CP}{;NL}	
[STATe:]MODE{?}{; NL}	0: CC, 1: CR, 2: CV, 3: CP
[STATe:]SHOR{SP}{ON OFF}{; NL}	
[STATe:]SHOR{?}{; NL}	0: OFF, 1: ON
[STATe:]PRES{SP}{ON OFF}{; NL}	
[STATe:]PRES{?}{; NL}	0: OFF, 1: ON
[STATe:]SENSe{SP}{ON OFF AUTO}{; NL}	
[STATe:]SENSe{?}{; NL}	0: OFF/AUTO, 1: ON
[STATe:]LEV{SP}{LOW HIGH}{; NL}	
[STATe:]LEV{?}{; NL}	0: LOW, 1: HIGH
[STATe:]DYN{SP}{ON OFF} {; NL}	
[STATe:]DYN{?}{; NL}	0: OFF, 1: ON
[STATe:]CLR{; NL}	
[STATe:]NG{?}{; NL}	0: GO, 1: NG
[STATe:]PROT{?}{; NL}	
[STATe:]CC{SP}{AUTO R2}{; NL}	
[STATe:]NGENABLE{SP}{ON OFF}{; NL}	
[STATe:]POLAR{SP}{POS NEG}{; NL}	
[STATe:]START{; NL}	
[STATe:]STOP{; NL}	
[STATe:]TESTING{?}{; NL}	0: TEST END, 1:TESTING
[STATe:]BATT:TEST{SP}{ON OFF}{; NL}	ON: Start test, OFF: Stop test

System command summary

Command	Note	Return
[SYStem:]RECall{SP}{m}{; NL}	m=1~150, m: State	
[SYStem:]STORe{SP}{m}{; NL}	m=1~150, m: State	
[SYStem:]REMOtE{; NL}	RS232/USB/LAN command	
[SYStem:]LOCAL{; NL}	RS232/USB/LAN command	
[SYStem:]NAME?{; NL}		"XXXXXX"
[SYStem:]*RST{; NL}		

Measure command summary

Command	Return
MEASure:CURRent{?}{; NL}	###.####
MEASure:VOLTage{?}{; NL}	###.####
MEASure:POWer{?}{; NL}	###.####
MEASure:VC{?}{; NL}	###.####,###.####

Remark	1. Current engineering unit: A
	2. Voltage engineering unit: V
	3. Resistance engineering unit: Ω
	4. Period engineering unit: mS
	5. Slew-rate engineering unit: A/ μ S
	6. Power engineering unit: W

Auto sequence command

Auto sequence command	Note	Return
FILE{SP}{n}{; NL}	n = 1 ~ 9	1 ~ 9
FILE{?}{; NL}	n = 1 ~ 9	1 ~ 9
STEP{SP}{n}{; NL}	n = 1 ~ 16	1 ~ 16
STEP{?}{; NL}	n = 1 ~ 16	1 ~ 16
TOTSTEP{SP}{n}{; NL}	Total step, n = 1 ~ 16	1 ~ 16
TOTSTEP{?}{; NL}	Total step, n = 1 ~ 16	1 ~ 16
SB{SP}{m}{; NL}	m = 1 ~ 150, m: STATE	
SB{?}{; NL}	m = 1 ~ 150, m: STATE	
TIME{SP}{NR2}{; NL}	100 ~ 9999 (ms)	100 ~ 9999 (ms)

SAVE{; NL}	Save "File n" data	
REPEAT{SP}{n}{; NL}	n = 0 ~ 9999	0 ~ 9999
REPEAT{?}{; NL}	n = 0 ~ 9999	0 ~ 9999
RUN{SP}{F}{n}{; NL}	n=1~9	Auto reply "PASS" or "FAIL: XX" (XX=NG STEP)

Command Syntax

The description of abbreviation

Command Tree	SP: Space, the ASCII code is 20 Hexadecimal. ;:Semicolon, Program line terminator, the ASCII code is 0A Hexadecimal. NL:New line, Program line terminator, the ASCII code is 0A Hexadecimal. NR2:Digits with decimal point. It can be accepted in the range and format of ###.#####. For Example: 30.12345, 5.0 The description of GPIB programming command syntax.
--------------	---

Communication Interface programming command syntax description

{ }	The contents of the { } symbol must be used as a part or data of the GPIB command, it cannot be omitted.
[]	The contents of the [] symbol indicates the command can be used or not. It depends on the testing application.

This symbol means option. For example “LOW | HIGH” means it can only use LOW or HIGH as the command, it can choose only one as the setting command.

Terminator: You have to send the program line terminator character after send the GPIB command, the available command terminator characters which can be accepted in PEL-5000G series mainframe is listed in table below

LF
LF WITH EOI
CR , LF
CR , LF WITH EOI

Semicolon “;”:The semicolon “;” is a back-up command, the semicolon allows you to combine command statement on one line to create command message.

Command List

Preset Commands	132
RISE	132
FALL	132
PERI or PERD	133
LDON _v	133
LDOF _v	134
CURR:HIGH LOW	134
CP:{HIGH LOW}	135
CR RES:{HIGH LOW}	135
CV:{HIGH LOW}	135
TCONFIG	136
OCP:START	137
OCP:STEP	137
OCP:STOP	137
OCP	137
VTH	138
OPP:START	138
OPP:STEP	138
OPP:STOP	138
OPP	139
STIME	139
BATT:UVP	139
BATT:TIME	139
BATT:AH	140
BATT:WH	140
BATT:TEST	140
BATT:RTIME	140
BATT:RAH	140
BATT:RWH	141
BATT:RVOLT	141
BATT:CC	141
BATT:CP	141
SURGE:SURI	142
SURGE:NORI	142
SURGE:TIME	142
SURGE:STEP	142
SURGE:ON OFF	143
BMS:ON OFF 1 0	143

BMS:STIME.....	143
SHORT:ITH.....	143
OCP:ITH.....	144
OCP:TSTEP.....	144
AVG.....	144
TURBO{ON OFF}.....	144
EXT:AIN{ON OFF}.....	145
SEQLD:TOTSTEP.....	145
SEQLD:TIME.....	145
SEQLD:CC.....	146
SEQLD:CP.....	146
Limit Commands.....	147
[LIMit:]CURREnt:{HIGH LOW} or IH IL.....	147
[LIMit:]POWEr:{HIGH LOW} or WH WL.....	147
[LIMit:]VOLtagE:{HIGH LOW} or VH VL.....	147
[LIMit:]SVH SVL.....	148
[LIMit:]ADDCV:VOLtagE.....	148
[LIMit:]ADDCV:CURR.....	149
[LIMit:]ADDCV:POW.....	149
[LIMit:]ADDCV:VOLtagE{SP}{ON OFF}.....	149
State Commands.....	150
[STATe:]LOAD.....	150
[STATe:]MODE.....	150
[STATe:]SHORt.....	150
[STATe:]PRESet.....	151
[STATe:]SENSe.....	151
[STATe:]LEVel or LEV{SP}{HIGH LOW}.....	152
[STATe:] DYNamic.....	152
[STATe:]CLR.....	152
[STATe:]NG?.....	153
[STATe:]PROTEct?.....	153
[STATe:]CCR{AUTO R2}.....	154
[STATe:]NGEABLE{ON OFF}.....	154
[STATe:]POLAR{POS NEG}.....	154
[STATe:]START.....	154
[STATe:]STOP.....	155
[STATe:]TESTING?.....	155
System Commands.....	156
[SYStem:]RECall.....	156
[SYStem:]STORe.....	156

[SYStem:]NAME?	156
[SYStem:]REMOTE	157
[SYStem:]LOCAL	157
Measure Commands	158
MEASure:CURRent?	158
MEASure:VOLTage?	158
MEASure:POWer?	158
Auto Sequence Commands	159
FILE	159
STEP	159
TOTSTEP	159
SB	159
TIME	160
SAVE	160
REPEAT	160
RUN	161

Preset Commands

Preset commands are used to set and read the default of load

	Set →
	→ Query
RISE	
Description	<p>Set and read the RISE SLEW-RATE.</p> <ul style="list-style-type: none"> • The definition of RISE SLEW-RATE is load level change or dynamic load can be programmed of RISE and FALL are completely independent. • The value of RISE has to be included the number of the decimal point, otherwise the command will not be available. • The least significant number is the 3th behind the decimal point. • PEL-5000G series will set to the maximum value of the model automatically when the set RISE is over the specification of Load. • The unit is A/uS.
Syntax	[PRESet:]RISE{SP}{NR2}{;NL}
Query Syntax	[PRESet:]RISE?{;NL}

	Set →
	→ Query
FALL	
Description	<p>Set and read the linear current. Set and read the FALL SLEW-RATE</p> <ul style="list-style-type: none"> • The definition of FALL SLEW-RATE is load level change or dynamic load can be programmed of RISE and FALL are completely independent. • PEL-5000G series will set to the maximum value of the model automatically when the FALL which has been set is over the specification of Load.

- The unit is A/uS.

Syntax [PRESet:]FALL{SP}{;|NL}

Query Syntax [PRESet:]FALL?{;|NL}

PERI or PERD

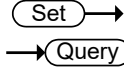

Description Set and read the TLOW and Thigh of DYNAMIC when loading.

- A period of loading waveform of DYNAMIC is combined by TLOW and THIGH.
- The value of TLOW and THIGH have to be included the number of the decimal point, otherwise the command will not be available.
- The least significant number is the 5th behind the decimal point.
- PEL-5000G series will set the value of TLOW or THIGH automatically when the value which has been set is over the maximum of the Load.
- The unit is mS.

Syntax [PRESet:]PERI|PERD:HIGH|LOW{SP}{NR2}{;|NL}

Query Syntax [PRESet:]PERI|PERD:HIGH|LOW?{;|NL}

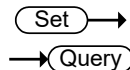

LDONv



Description Set and read the voltage of LOAD ON. This command is for setting the load voltage value of LOAD ON.

Syntax [PRESet:]LDONv{SP}{NR2}{;|NL}

Query Syntax [PRESet:]LDONv?{;|NL}

		
		
<hr/>		
LDOFv		
Description	Set and read the voltage of LOAD OFF. This command is for setting the load voltage value of LOAD OFF.	
Syntax	[PRESet:]LDOFv{SP}{NR2}{; NL}	
Query Syntax	[PRESet:]LDOFv?{; NL}	

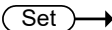
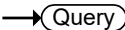
		
		
<hr/>		
CURR:HIGH LOW		
Description	<p>Set and read the current of HIGH LOW. This command is for setting the required Load current. And this command must be followed the next notices:</p> <ul style="list-style-type: none"> • The required value of current must be included the number of the decimal point, otherwise the command will not be available. • The least significant number is the 5th behind the decimal point. • PEL-5000G series will set the maximum value of current of the load automatically when the value which has been set is over the maximum of the load. • The value of LOW has to be smaller than HIGH. • The unit is A 	
Syntax	[PRESet:]CC CURR:HIGH LOW{SP}{NR2}{; NL}	
Query Syntax	[PRESet:]CC CURR:HIGH LOW?{; NL}	

CP:{HIGH|LOW}



Description Set and read the value of watt. This command is for setting the required value of watt, and the unit is W

Syntax [PRESet:]CP:{HIGH|LOW}{SP}{NR2}{;|NL}

Query Syntax [PRESet:]CP:{HIGH|LOW}?{;|NL}

CR|RES:{HIGH|LOW}



Description Set and read the value of resistance. This command is used for setting the required value of load resistance. And this command must be followed the next notices:

- The required value of resistance must be included the number of the decimal point, otherwise the command will not be available.
- The least significant number is the 3rd behind the decimal point.
- PEL-5000G series will set to the maximum value of the model automatically when the value of Resistance which has been set is over the specification of load.
- The Resistance value which has been set of LOW has to be smaller than HIGH.
- The unit is Ω .

Syntax [PRESet:]CR|RES:{HIGH|LOW}{SP}{NR2}{;|NL}

Query Syntax [PRESet:]CR|RES:{HIGH|LOW}?{;|NL}

CV:{HIGH|LOW}





Description Set and read the value of load voltage. This command is used for setting the required load

voltage. And this command must be followed the next notices:

- The required value of resistance must be included the number of the decimal point, otherwise the command will not be available.
- The least significant number is the 5th behind the decimal point.
- PEL-5000G series will set to the maximum value of the model automatically when the value of voltage which has been set is over the specification of load.
- The voltage value which has been set of LOW has to be smaller than HIGH.
- The unit is voltage (V)

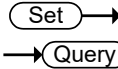
Syntax	[PRESet:]CV:{HIGH LOW}{SP}{NR2}{; NL}
Query Syntax	[PRESet:]CV:{HIGH LOW}?{; NL}















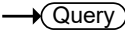

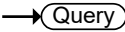
TCONFIG

Description Set and read the function of dynamic test. There are four options of this command. Those are NORMAL mode, OCP test, OPP test and SHORT test.

Syntax	[PRESet:] TONFIG {NORMAL OCP OVP OPP SHORT}{; NL}
Query Syntax	[PRESet:] TONFIG?{; NL}

Return Parameter	<NR2>	
	1	NORMAL
	2	OCP
	3	OPP
	4	SHORT

		 
<hr/>		
OCP:START		
<hr/>		
Description	Set and read the initial value of OCP test. This command is used for setting the required initial value (I-START) of OCP test.	
Syntax	[PRESet:]OCP:START{SP}{NR2}{: NL}	
Query Syntax	[PRESet:]OCP:START?{: NL}	
<hr/>		
		 
<hr/>		
OCP:STEP		
<hr/>		
Description	Set and read the increasing value of OCP test. This command is used for setting the increasing value (I-STEP) of OCP test.	
Syntax	[PRESet:]OCP:STEP{SP}{NR2}{: NL}	
Query Syntax	[PRESet:]OCP:STEP?{: NL}	
<hr/>		
		 
<hr/>		
OCP:STOP		
<hr/>		
Description	Set and read the maximum value of OCP test. This command is used for setting the maximum value (I-STOP) of OCP test.	
Syntax	[PRESet:]OCP:STOP{SP}{NR2}{: NL}	
Query Syntax	[PRESet:]OCP:STOP?{: NL}	
<hr/>		
		 
<hr/>		
OCP		
<hr/>		
Description	Read OCP testing current. This command is used for reading OCP current.	
Query Syntax	OCP?	
<hr/>		

		
VTH		
<hr/>		
Description	Set and read the value of the threshold voltage. This command is used for setting the threshold voltage. That is the OCP/OPP of this load model when the output voltage of appliance is lower or equaled to the VTH	
Syntax	[PRESet:]VTH{SP}{NR2}{; NL}	
Query Syntax	[PRESet:]VTH?{; NL}	
<hr/>		
		
OPP:START		
<hr/>		
Description	Set and read the initial value of OPP test. This command is used for setting the required initial value (P-START) of OPP test.	
Syntax	[PRESet:]OPP:START{SP}{NR2}{; NL}	
Query Syntax	[PRESet:]OPP:START?{; NL}	
<hr/>		
		
OPP:STEP		
<hr/>		
Description	Set and read the increasing value of OPP test. This command is used for setting the increasing value (P-STEP) of OPP Test.	
Syntax	[PRESet:]OPP:STEP{SP}{NR2}{; NL}	
Query Syntax	[PRESet:]OPP:STEP?{; NL}	
<hr/>		
		
OPP:STOP		
<hr/>		
Description	Set and read the maximum value of OPP test. This command is used for setting the maximum value (P-STOP) of OPP test	

Syntax [PRESet:]OPP:STOP{SP}{NR2}{;|NL}

Query Syntax [PRESet:]OPP:STOP?{;|NL}

OPP Set
→ Query

Description Read OPP testing watt. This command is used for reading OPP watt.

Query Syntax OPP?

STIME Set →
→ Query

Description Set and read time of the short-circuit test. This command is used for setting time of the short-circuit test. If time set to 0, it means that have no the time limit and continue to be short -circuited. The unit is milli-second (ms)

Syntax [PRESet:]STIME{SP}{NR2}{;|NL}

Query Syntax [PRESet:]STIME?{;|NL}

BATT:UVP Set →

Description Set under voltage protect. This command is to set battery discharge test mode Disch CC or Disch CP under voltage protect voltage, unit is voltage (V).

Syntax [PRESet:] BATT:UVP {SP}{NR2}{;|NL}

BATT:TIME Set →

Description Set battery discharge test mode time. This command is to set battery discharge test mode Disch CC or Disch CP discharge test time, n=1~99999, unit is second(s).

Syntax [PRESet:]BATT:TIME{SP}{n}{;|NL}

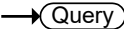
	
BATT:AH	
<hr/>	
Description	Set and read BATT Stop AH. This command is used to set and read BATT Stop AH.
Syntax	[PRESet:]BATT:AH{SP}{NR2}{; NL}
Query Syntax	[PRESet:]BATT:AH?{; NL}

	
BATT:WH	
<hr/>	
Description	Set and read BATT STOP WH. This command is to set and read BATT STOP WH.
Syntax	[PRESet:]BATT:WH{SP}{NR2}{; NL}
Query Syntax	[PRESet:]BATT:WH?{; NL}

BATT:TEST	
<hr/>	
Description	Set BATT TESTS. This command is to set BATT TEST, ON: start the test, OFF: stop the test.
Syntax	[PRESet:]BATT:TEST{SP}{NR2}{; NL}

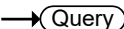
BATT:RTIME	 
<hr/>	
Description	Read BATT RTIME. This command is to read BATT RESULT TIME.
Query Syntax	[PRESet:]BATT:RTIME?{; NL}

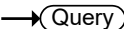
BATT:RAH	 
<hr/>	
Description	Read BATT RAH. This command is used to read the battery result AH.

Query Syntax [PRESet:]BATT:RAH?{;|NL}

Set

BATT:RWH

→ Query

Description Read BATT RWH. This command is used to read the battery result WH.

Query Syntax [PRESet:]BATT:RWH?{;|NL}

Set

BATT:RVOLT

→ Query

Description Read BATT RVOLT. This command is used to read the battery result VOLT.

Query Syntax [PRESet:]BATT:RVOLT?{;|NL}

Set →

BATT:CC

→ Query

Description Set or read the current for the Batt test. The unit is "A".

Syntax [PRESet:]BATT: CC{SP}{NR2}{;|NL}

Set →

BATT:CP

→ Query

Description Set and read the Watt for the Batt test. The unit is "W".

Syntax [PRESet:]BATT: CP{SP}{NR2}{;|NL}

SURGE:SURI

Set →
→ Query

Description Set and read surge current mode loading current value. This command is used to set and read surge current mode testing loading value XXX.XXX (A) SURGE CURRENT.

Syntax [PRESet:]SURGE:SURI{SP}{NR2}{;|NL}

Query Syntax [PRESet:]SURGE:SURI?{;|NL}

SURGE:NORI

Set →
→ Query

Description Set and read surge mode normal current test loading current value. This command is used to set and read normal current testing mode loading current value XXX.XXX (A) NORMAL CURRENT.

Syntax [PRESet:]SURGE:NORI{SP}{NR2}{;|NL}

Query Syntax [PRESet:]SURGE:NORI?{;|NL}

SURGE:TIME

Set →
→ Query

Description Set and read surge mode current testing time. This command is used to set and read surge mode testing time, SURGE TIME:10~1000ms

Syntax [PRESet:]SURGE:TIME{SP}{NR2}{;|NL}

Query Syntax [PRESet:]SURGE:TIME?{;|NL}

SURGE:STEP

Set →
→ Query

Description Set and read surge mode diminishing current setting value. This command is used to set and read surge mode diminishing current setting value, n=1~5

Syntax [PRESet:]SURGE:STEP{SP}{NR2}{:};|NL}

Query Syntax [PRESet:]SURGE:STEP?{:};|NL}

SURGE:ON|OFF

Set →

→ Query

Description Set and read surge mode ON or OFF. This command is used to set and read surge mode ON or OFF, ON: Run surge, OFF: Stop surge.

Syntax [PRESet:]SURGE:{ON|OFF}{:};|NL}

Query Syntax [PRESet:]SURGE:{ON|OFF}?{:};|NL}

BMS:ON|OFF|1|0

Set →

Description Set BMS ON or OFF. This command is used to enable or disable BMS test function. ON: Enable, OFF: Disable.

Syntax [PRESet:]BMS{SP}{ON|OFF|1|0}{:};|NL}

BMS:STIME

Set →

Description Set BMS Short time. This command is used to set BMS short time. Range is 0.05~10ms and unit is ms.

Syntax [PRESet:]BMS:STIME{SP}{NR2}{:};|NL}

SHORT:ITH

Set →

Description Set BMS Short ITH. This command is used to set BMS short ITH. Unit is A.

Syntax [PRESet:]SHORT:ITH{SP}{NR2}{:};|NL}

OCP:ITH

Set →

Description Set BMS OCP ITH. This command is used to set BMS OCP ITH. Unit is A.

Syntax [PRESet:]OCP:ITH{SP}{NR2}{;|NL}

OCP:TSTEP

Set →

Description Set BMS OCP TSTEP. This command is used to set the range of BMS OCP TSTEP 0.05~10ms / 11~1000ms. Unit is ms.

Syntax [PRESet:]OCP:TSTEP{SP}{NR2}{;|NL}

AVG

Set →

→ Query

Description Set and read voltage value/current value/watt value average times. This command is used to set Vmeter/Ameter/Wmeter setting measure average times, MEAS AVG 1~64 setting, initial value 1.

Syntax [PRESet:]AVG{SP}{NR2}{;|NL}

Query Syntax [PRESet:]AVG?{;|NL}

TURBO{ON|OFF}

Set →

Description Set TURBO On or Off. This command is used to set turbo on or off.

Syntax [PRESet:]TURBO{SP}{ON|OFF}{;|NL}

EXT:AIN{ON|OFF}

Set →

Description External Analog input ON of OFF. This command is used to set external analog input ON or OFF.

Syntax [PRESet:]EXT:AIN {SP}{ON|OFF}{:|NL}

SEQLD:TOTSTEP

Set →

→ Query

Description Set and read the total test levels of SEQ MODE, n=2~16

Syntax SEQLD:TOTSTEP{SP}{n}{:|NL}

Query Syntax SEQLD:TOTSTEP{?}{:|NL}

SEQLD:TIME

Set →

→ Query

Description Set and read the test time of all levels of SEQ MODE. This command is to set and read the test time of each level of SEQ MODE, n = 0 ~ 15, time input range is 0.02~999000, the unit is ms. There are 3 time range: r0 = 0.02 ~ 1ms, resolution is 10us. Timing r0 cannot be set in the first Step (ΔT_0), r1 = 2 ~ 65535ms resolution is 1ms, r2 = 66 ~ 999s resolution is 1Sec.

Syntax SEQLD:TIME{n}{SP}{NR2}{:|NL}

Query Syntax SEQLD:TIME{?}{:|NL}

		Set →
		→ Query
SEQLD:CC		
Description	Set and read the test current value of each level of SEQ CC MODE. This command is to set and read the test current of each level of SEQ CC MODE, n = 0 ~ 15, the unit is ampere (A).	
Syntax	SEQLD:CC{n}{SP}{NR2}{; NL}	
Query Syntax	SEQLD:CC{n}{?}{; NL}	

		Set →
		→ Query
SEQLD:CP		
Description	Set and read the test power value of each level of SEQ CP MODE. This command is to set and read the test power of each level of SEQ CP MODE, n = 0 ~ 15, the unit is watts (W), if it be set to Range 1, all CP values cannot exceed the power value of Range 1.	
Syntax	SEQLD:CP{n}{SP}{NR2}{; NL}	
Query Syntax	SEQLD:CP{n}{?}{; NL}	

Limit Commands

[LIMit:]CURRent:{HIGH|LOW} or IH|IL





Description	This command is to set the upper/lower limit value of threshold current. When load sink current is lower than this lower limit value or higher than the upper limit value, NG indicating light will come on to indicate “NO GOOD”.
-------------	--

Syntax	[LIMit:]CURRent:{HIGH LOW}{SP}{NR2 }{; NL} [IH IL]{SP}{NR2 }{; NL}
--------	---

Query Syntax	[LIMit:]CURRent:{HIGH LOW}?{; NL} [IH IL]?{; NL}
--------------	---

[LIMit:]POWer:{HIGH|LOW} or WH|WL



Description	This command is to set the upper/lower limit value of threshold power (WATT). When power (WATT) is lower than this lower limit value or higher than the upper limit value, NG indicating light will come on to indicate “NO GOOD”.
-------------	--

Syntax	[LIMit:]POWer:{HIGH LOW}{SP}{NR2 }{; NL} [WH WL]{SP}{NR2 }{; NL}
--------	---

Query Syntax	[LIMit:]POWer:{HIGH LOW}?{; NL} [WH WL]?{; NL}
--------------	---

[LIMit:]VOLtage:{HIGH|LOW} or VH|VL

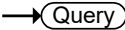

Description	This command is to set the upper/lower limit value of threshold voltage. When input voltage is lower than the lower limit value or higher than the upper limit value, NG indicating light will
-------------	--

come on to indicate “NO GOOD”.

Syntax	[LIMit]:VOLtage:{HIGH LOW}{SP}{NR2 }{; NL} [VH VL]{SP}{NR2}{; NL}
Query Syntax	[LIMit]:VOLtage:{HIGH LOW}?{; NL} [VH VL]?{; NL}

[LIMit:]SVH|SVL

Set →

→ Query

Description This command is to set the upper/lower limit value of short current. When short current is lower than the lower limit value or higher than the upper limit value, NG indicating light will come on to indicate “NO GOOD”.

Syntax	[LIMit:]{SVH SVL}{SP}{NR2 }{; NL}
Query Syntax	[LIMit:]{SVH SVL}?{; NL}

[LIMit:]ADDCV:VOLtage



Set →

→ Query

Description Set and read CC + CURRENT LIMIT or CP+CV mode of constant voltage setting. This command is used for set and read constant voltage setting. When set to CC + CURRENT LIMIT, the of load like constant current status, until EUT voltage equal setting constant voltage, into a constant voltage mode.

This command is used for setting and read constant voltage setting. When set to CP+CV, the of load like constant power status, until EUT Voltage equal setting constant voltage, into a constant voltage mode.

Syntax	[LIMit:]ADDCV:VOLtage{SP}{NR2 }{; NL}
Query Syntax	[LIMit:]ADDCV:VOLtage{SP}?{; NL}

		
		
<hr/>		
[LIMit:]ADDCV:CURR		
Description	Set and read the Constant current value of CC + CURRENT LIMIT mode. When in CC + CURRENT LIMIT mode, the load will be loaded with a Constant current until the voltage of the object under test is equal to the set Constant voltage value, then it will switch to the Constant voltage mode. This command is used to set and read its Constant current setting value.	
Syntax	LIMit:ADDCV:CURR{SP}{NR2}{; NL}	
Query Syntax	LIMit:ADDCV:CURR{SP}?{; NL}	

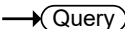
		
		
<hr/>		
[LIMit:]ADDCV:POW		
Description	Set and read the Constant current value of CP+CV mode. When in CP+CV mode, the load will be loaded in a Constant power mode until the voltage of the object under test is equal to the set Constant voltage value, then it will switch to the Constant voltage mode. This command is used to set and read its Constant power setting value.	
Syntax	[LIMit:]ADDCV:VOLtage{SP}{NR2}{; NL}	
Query Syntax	[LIMit:]ADDCV:VOLtage{SP}?{; NL}	

[LIMit:]ADDCV:VOLtage{SP}{ON OFF}		
Description	Start and stop CC + CURRENT LIMIT or CP+CV test mode. At that time in constant current mode or constant power mode to perform CC + CV or CP + CV mode.	
Syntax	[LIMit:]ADDCV:VOLtage{SP}{ON OFF}{; NL}	

State Commands

State commands are used to set and read the status of load

		Set →
		→ Query
[STATe:]LOAD		
Description	Set and read the status of sink current or not. This command is used for setting the status of sink current. When setting is set to ON, the load is going to sink current from appliance. When setting is set to OFF, the load would not act.	
Syntax	[STATe:]LOAD{SP}{ON OFF}{; NL}	
Query Syntax	[STATe:]LOAD?{; NL}	
Parameter	0	ON
	1	OFF

		Set →
		→ Query
[STATe:]MODE		
Description	Set and read the mode of load. Load is acting under these four modes as the following table. When reading the load operation mode, return value 0 1 2 3 are meant to be CC CR CV CP	
Syntax	[STATe:]MODE{SP}{CC CR CV CP}{; NL}	
Query Syntax	[STATe:]MODE?{; NL}	
Module for each series	Mode (value)	CC CR CV CP
		0 1 2 3
	PEL-5000G	V V V V

		Set →
		→ Query
[STATe:]SHORT		
Description	This command is for setting the load to make a short-circuit test. While setting for the ON, the V+, V- pin of load like short-circuit status.	

Syntax	[STATe:]SHORT{SP}{ON OFF}{; NL}
Query Syntax	[STATe:]SHORT?{; NL}

[STATe:]PRESet

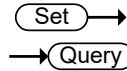

Description	<p>Set and read the left or right digit multi-function meter to display the programming load level. This command is for selecting the left 5 digit LCD display to show current setting or DWM.</p> <p>Pres ON: Select the LCD display to show current setting.</p> <p>Pres OFF: Select the LCD display to show "DWM"</p>
-------------	--

Syntax	[STATe:]PRESet{SP}{ON OFF}{; NL}
Query Syntax	[STATe:]PRESet?{; NL}

Parameter	0	OFF
	1	ON

[STATe:]SENSe

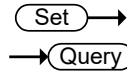

Description	<p>Set and read load voltage. This command is for setting the load voltage and read whether it is carried by VSENSE or input connector. When setting is ON, the voltage is gotten from VSENSE, and when setting is OFF, the voltage is gotten from input connector. For PEL-5000G series, the optional are ON and AUTO. So, if setting is AUTO, it means the voltage is gotten and read from VSENSE. But if no voltage is inputted from VSENSE, the voltage will be inputted from input connector.</p>
-------------	--

Syntax	[STATe:]SENSe{SP}{ON OFF AUTO}{; NL}
Query Syntax	[STATe:]SENSe?{; NL}

(Set) →

[STATE:]LEVel or LEV{SP}{HIGH|LOW } → (Query)

Description	Set and read the LOW and HIGH of load. LEV LOW is a low level value of current on CC mode. It is a low level value of resistance on CR mode. It is a low level value of voltage on CV mode. It is a low level value of power on CP mode.				
Syntax	[STATE:]LEVel{SP}{HIGH LOW }{; NL} [STATE:]LEV{SP}{HIGH LOW}{; NL}				
Query Syntax	[STATE:]LEVel?{; NL} [STATE:]LEV?{; NL}				
Parameter	<table border="1"> <tr> <td>0</td> <td>LOW/A</td> </tr> <tr> <td>1</td> <td>HIGH/B</td> </tr> </table>	0	LOW/A	1	HIGH/B
0	LOW/A				
1	HIGH/B				

(Set) →

[STATE:] DYNamic	
Description	Set and read whether the status of load is dynamic or static <ol style="list-style-type: none"> 1. DYN ON stands for a DYNAMIC Load. 2. DYN OFF stands for a STATIC Load.
Syntax	[STATE:]DYNamic{SP}{ON OFF}{; NL}
Query Syntax	[STATE:]DYNamic?{; NL}

(Set) →

[STATE:]CLR	
Description	Clear the error flag of PEL-5000G series during the period of working. This command is for clearing the contents in the register of PROT and ERR. After implementation, the contents of these two registers will be "0".
Syntax	[STATE:]CLR{; NL}

[STATe:]NG? Set
→ Query

Description Query if there is NG flag in this PEL-5000G series. The command “NG?” is used to show the NG status. When “0” is set, the LCD of NG (NO GOOD) will be put out. When “1” is set, the LCD will be lit.

Query Syntax [STATe:]NG?{;|NL}

Return Parameter	1	GO
	0	NG

[STATe:]PROTect? Set
→ Query

Description Query if there is protection flag has been set in this PEL-5000G series.

- PROT? means that the status of protection of PEL-5000G. “1” means OPP occurred. “4” means OVP. “8” means OCP. The table below shows the corresponding number of protection status.
- Use command CLR to clear the register of PROT status to be “0”

Query Syntax [STATe:]PROTect?{;|NL}

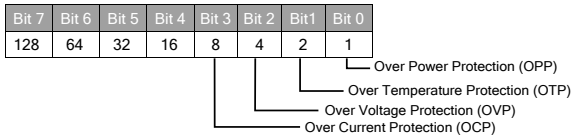

Register of PROT status	BIT ID	BIT VALUE	REMARK
	bit 0	0 = Off, 1 = Triggered	Over Power Protection (OPP)
	bit 1	0 = Off, 1 = Triggered	Over Temperature Protection (OTP)
	bit 2	0 = Off, 1 = Triggered	Over Voltage Protection (OVP)
	bit 3	0 = Off, 1 = Triggered	Over Current Protection (OCP)

[STATe:]CCR{AUTO|R2}



Description Set the CC mode range to be forced to switch to Range II. It will switch the range position automatically when setting to AUTO and set when implementing RANGE II when setting to R2

Syntax [STATe:]CCR{AUTO|R2}{;|NL}

[STATe:]NGEABLE{ON|OFF}



Description Set the GO/NG check function enable or disable. To set the function of NG judgment open when POWER ON. When setting for POWER OFF, the function of NG judgment will not be implemented.

Syntax [STATe:]NGEABLE{ON|OFF}{;|NL}

[STATe:]POLAR{POS|NEG}



Description Set for the display of the voltage meter shows the pole is contrary or not. If it shows POS that means the pole is not contrary. If the pole is contrary, it will show NEG.

Syntax [STATe:]POLAR {POS|NEG}{;|NL}

[STATe:]START



Description Set to implement the test for load, and according to TEST CONFIG (TCONFIG), the load will start to test the items and parameters which are required

Syntax [STATe:]START{;|NL}

[STATe:]STOP

Set →

Description Set to stop the test for load

Syntax [STATe:]STOP{;|NL}

[STATe:]TESTING?

Set
→ Query

Description Query to whether the PEL-5000G series is in the
test execution state. (0: Test end, 1: During testing)

Query Syntax [STATe:]TESTING{?}{;|NL}

System Commands

System commands are used to set and read the status of PEL-5000G series

[SYStem:]RECall

Set →

Description Recall the status of loading which has been saved in the memory. This command is for recalling the status of load which has been saved in the memory. m(STATE)=1~150.

Syntax [SYStem:]RECall{SP}m{;|NL}

Example RECALL 2
Recall the status of loading which has been saved in the 2nd of the memory

[SYStem:]STORE

Set →

Description Save the status of loading to the memory. This command is for saving the status of loading to the memory. m(STATE)=1~150

Syntax [SYStem:]STORE{SP}m{;|NL}

Example STORE 2
Save the status of loading which has been saved in the 2nd of memory.

[SYStem:]NAME?

Set
→ Query

Description Read the model number of load. This command is for reading the model number of load. If no module is operating, the display will be lit "NULL", or it will be lit the model number as

shown in following table.

Query Syntax [SYStem:]NAME?{;|NL}

Model

PEL-5004G-150-400 PEL-5004G-600-280 PEL-5004G-1200-160

PEL-5005G-150-500 PEL-5005G-600-350 PEL-5005G-1200-200

PEL-5006G-150-600 PEL-5006G-600-420 PEL-5006G-1200-240

[SYStem:]REMOTE

Set →

Description Use this command to enter remote status (only for RS232). This command is for controlling the RS232.

Syntax [SYStem:]REMOTE{;|NL}

[SYStem:]LOCAL

Set →

Description Use the command to exit remote status (only for RS 232). This command is for finishing the RS232

Syntax [SYStem:]LOCAL{;|NL}

Measure Commands







Measure the actual current and voltage value of Load

		Set
MEASure:CURRent?		→ Query
Description	Read the current which is loading from load. Read the five digits of current meters, and the unit is Ampere (A)	
Query Syntax	MEASure:CURRent?{; NL}	

		Set
MEASure:VOLTage?		→ Query
Description	Read the voltage which is loading from load. Read the five digits of current meters, and the unit is Voltage (V)	
Query Syntax	MEASure:VOLTage?{; NL}	

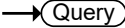
		Set
MEASure:POWer?		→ Query
Description	Read the power which is loading from load. Read the five digits of current meters, and the unit is Watt (W)	
Query Syntax	MEASure:POWer?{; NL}	

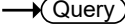
Auto Sequence Commands

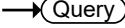
		 
<hr/>		
FILE		
Description	Set file numbers of Auto Sequence. Reads the automatic test number setting of the AUTO Sequence function and the set automatic test number.	
	The setting range is 1-9, and the number is the automatic test number.	
Syntax	FILE{SP}{n}{; NL}	
Query Syntax	FILE{?}{; NL}	
<hr/>		
		 
<hr/>		
STEP		
Description	Set step numbers of sequence step. The n is 1~16	
Syntax	STEP{SP}{n}{; NL}	
Query Syntax	STEP {?}{; NL}	
<hr/>		
		 
<hr/>		
TOTSTEP		
Description	Set total step numbers of sequence step. The n is 1~16	
Syntax	TOTSTEP{SP}{n}{; NL}	
Query Syntax	TOTSTEP {?}{; NL}	
<hr/>		
		 
<hr/>		
SB		
Description	Set and read the memory bank. Set the step execution content to the step with the automatic test number Set by the "STEP" command.	
<hr/>		

The step execution contents are various setting states (up to 150 types) saved in the PEL-5000G series memory. The setting range is 1: Various setting states 1 – 150: Various setting states 150.

Syntax SB{SP}{m,n}{;|NL}

Query Syntax SB{?}{;|NL}

TIME

Set →

Description The setting range is 100-9999, and the unit is “ms”. Set the step execution time of the automatic test number set by the “STEP” command, and read the set step execution time.

Syntax TIME{SP}{NR2}{;|NL}

SAVE

Set →

Description Save auto sequence edit data. Saves the settings of the automatic test number set by the “FILE” command.

Syntax SAVE{;|NL}

REPEAT

Set →

→ Query

Description Set repeat time for the sequence step. Read the execution repeat count setting of the automatic test number set by the “FILE” command and the set repeat count. Setting range: 0-9999

Syntax REPEAT{SP}{n}{;|NL}

Query Syntax REPEAT{?}{;|NL}

RUN

Description	Run the sequence file number. Specify an automatic test number and run the automatic test against that number. Specified range: 1 to 9. When the automatic test is finished, you will receive an auto reply.
-------------	---

Syntax	<code>RUN{SP}{F}{n}{; NL}</code>
--------	----------------------------------

AAPPLICATION

This chapter details the basic operating modes along with some common applications in which the PEL-5000G series Electronic Load is used.

Local sense connections	164
Remote sense connections	165
Constant Current mode application	166
Constant Voltage mode application.....	169
Constant Resistance mode application	171
Constant Power mode application.....	173
Applications with current limiting or power limiting function CV mode operation (charging device)	175
CV + Current Limit mode of operation application	177
CV + Power Limit mode of operation application	179
Constant current source operating.....	181
Zero-Volt loading application.....	182
Parallel operation	183
Power Supply OCP testing	184
Power Supply OPP testing	186
SHORT testing.....	188
Battery discharge test	190
Disch CC/ Disch CP measure discharge capacity	190
CV + Current Limit	190
CV + Power Limit	190
Abnormal testing of power supply	192
BMS Protective device	195
Model 9923 current waveform generator.....	204
9923 Current Waveform generator application software.....	205

Typical applications.....	206
Stand-alone application (no need for a computer connection).....	211
Parallel applications.....	211
9923 Installation method	212
SEQUENCE LOAD (remote only)	213

Local sense connections

Background

Local sensing is used in applications where the lead lengths are relatively short, or where load regulation is not critical. When connected in local sense mode the 5 digit voltage meter of the PEL-5000G series electronic load measures the voltage at its DC input terminals. The connecting leads between the DUT and the electronic load should be bundled or tie wrapped together to minimize inductance.

The diagram below illustrates a typical set up with the electronic load connected to the DC power supply.

Local voltage sense connections

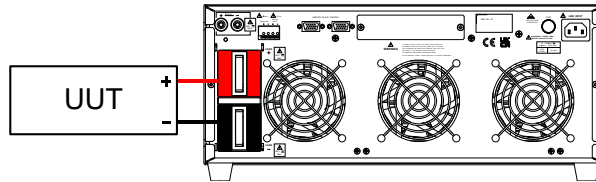

Remote sense connections

Background Remote sensing compensates for the voltage drop in applications that require long lead lengths. It is useful under low voltage high current conditions. The remote voltage sense terminals (V_{s+}) and (V_{s-}) of the load are connected to (+) and (-) output of the DC Source. Be sure to observe the correct polarity or damage may occur. The power and sense cables should be bundled or tie wrapped together to minimize inductance.

The diagram below illustrates a typical set up with the electronic load connected for remote sense operation.

If V-sense is set to "ON" and the sense terminals are connected to the DUT the load will check and compensate for all voltage drops. The maximum voltage sense compensation is the same as the rating of the PEL-5000G series.

Example V_{max} of PEL-5004G-150-400, PEL-5005G-150-500, and PEL-5006G-150-600 is 150Vdc so maximum V_{sense} is also 150Vdc.

V_{max} of PEL-5004G-600-280, PEL-5005G-600-350, and PEL-5006G-600-420 is 600Vdc so maximum V_{sense} is also 600Vdc.

V_{max} of PEL-5004G-1200-160, PEL-5005G-1200-200G, and PEL-5006G-1200-240G is 1200Vdc so maximum V_{sense} is also 1200Vdc.

Remote voltage sense connections

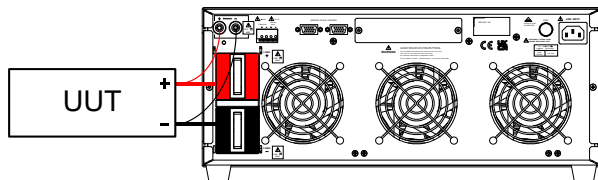

Constant Current mode application

Background The Constant Current (CC) mode is ideal for testing the Load Regulation, Cross Regulation, Output Voltage and Dynamic Regulation of the power supply under test. The CC mode can also be used to test the Discharge Characteristics and the Life Cycle of cells and battery packs. In CC operation the PEL-5000G series can operate as a static load with switchable high and low current levels. It is also possible to operate the load dynamically enabling the user to adjust sink current with time.

Static mode Major application areas include:

- Voltage source testing
- Power supply load regulation testing
- Battery discharge testing

Constant current mode application

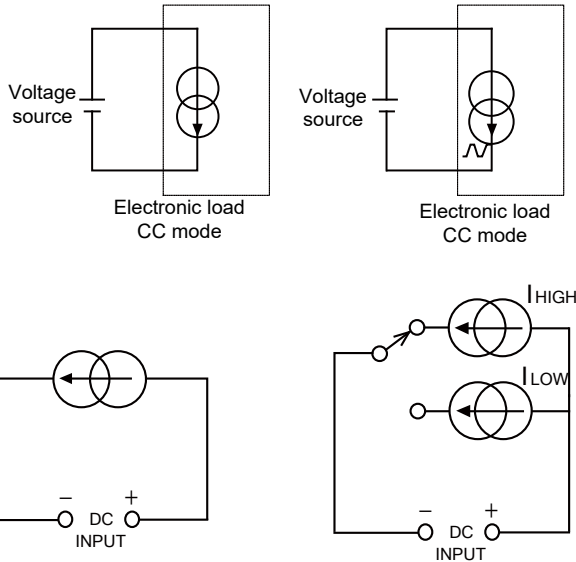

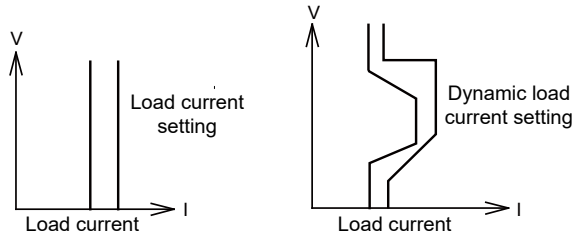

Dynamic mode The built-in pulse generators allow the user to recreate real world loads that vary with time.

Major application areas include:

- Power supply load transient response testing
- Power recovery time testing
- Battery Pulse load simulation
- Power component testing
- Two levels of current can be set and the rate of change between the 2 current levels can be adjusted in relation to time. The current rise (slew) rate and the current fall (slew) rate can be adjusted independently from each other and are further defined below.
- Rise slew rate = $|I_{low} - I_{high}| / T_a$ (A/us)
- Fall slew rate = $(I_{high} - I_{low}) / T_b$ (A/us)
- Rise time(T_a) = $(I_{low} - I_{high}) / \text{Rise slew rate}$
- Fall time(T_b) = $(I_{high} - I_{low}) / \text{Fall slew rate}$
- Please see page 168 for more information on slew rates.
- The time the waveform is high (T_{high}) and the time the waveform is low (T_{low}) can also be adjusted. The diagram below shows the 6 adjustable parameters that define the dynamic waveform.
-

Analogue programming input

The analogue programming input can also be used in CC mode. The analogue programming input allows a complex dynamic waveform to be set up on an external oscillator. The PEL-5000G series load will track and load according to the external signal as long as it is within its dynamic capability. The input signal can be the range of 0-10V (dc+ac). The 10V is proportional to the full current capability of the load.

Dynamic load current with independent programmed Rise/Fall slew rate

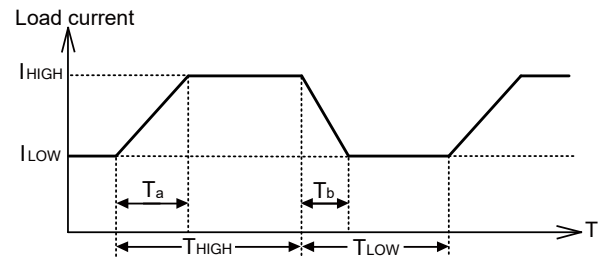

Constant Voltage mode application

Background	<p>In Constant Voltage (CV) operation the load will attempt to sink as much current as required in order to reach the set voltage value. CV operation is useful in checking the load regulation of dc current sources. The CV mode is also ideal for characterizing the current limit of dc power supplies. These application areas are explained a little more below.</p>
Current source testing	<p>A common application for a dc current source is as a battery charger. Most battery chargers are designed to automatically adjust their charging current according to the battery voltage. In CV mode the electronic load will sink the current that is needed to reach the desired voltage. The CV mode is therefore ideal for checking the charge current at a particular voltage level.</p> <p>If the battery charger is tested at a number of different voltage levels in CV mode a current curve can be recorded. Thus the battery charger's load regulation can be checked during development, production and batch testing</p>
Power supply current limit characterization	<p>The current limit is a necessary function for power supplies. The fold back current limit curve is very common for fixed output switching power supplies. The constant current limit curve is more popular for adjustable laboratory power supplies.</p> <p>It is very difficult or impossible to find the current limit curve by CC or CR mode. However it becomes simple by using CV mode. The user sets the CV voltage and Records the output current. Plotting the current measurements against the voltage settings result in the output current limit curve of a power supply</p>

Constant Voltage mode application

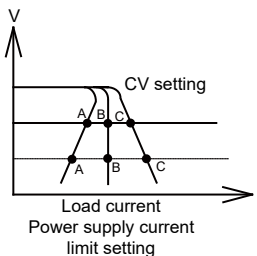
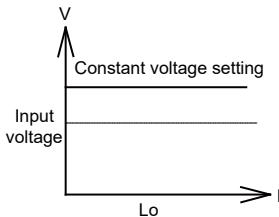
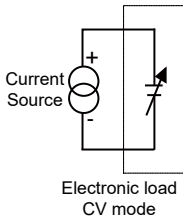
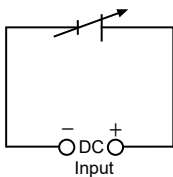

Constant Resistance mode application

Background	Operating in Constant Resistance mode is useful for testing both voltage and current sources. The CR mode is particularly suited for the “soft start” of power supplies. This is explained in more detail below.
Power supply power up sequence	In constant current mode the demand at initial “Load ON” of the preset current value is almost instantaneous. This might cause the Device under Test (DUT) problems meeting the relatively high current demand at initial switch on.
Example	<p>A 5V/50A output power supply may not be able to deliver 50A over its entire start-up range of 0-5 volts. In many cases the power supply’s short circuit or over current protection circuit cause the power supply to shut down. This is because the power supply is trying to deliver the 50A at a voltage level that is too low.</p> <p>The answer to this problem is not to use CC mode but to use CR mode instead. This is because in CR mode the current and voltage ramp up together providing a “soft start” when compared to standard CC mode.</p> <p>However please note that with the PEL-5000G series of Electronic Loads an adjustable current ramp can be set. This feature is found within the dynamic settings as RISE slew rate. Even in static mode the PEL-5000G Series load will regulate its current demand at “Load ON” in line with the adjusted RISE slew rate. The FALL slew rate also in the dynamic settings allows the current ramp down to be controlled at “Load OFF”.</p>

Constant
Resistance mode
Application

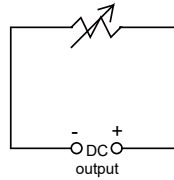
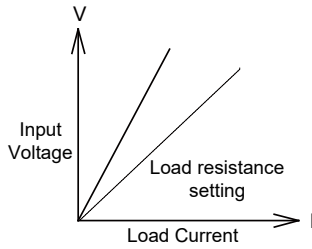
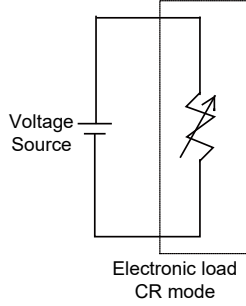
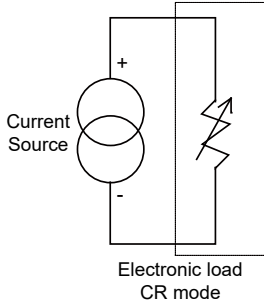

Constant Power mode application

Background

Battery Evaluation

Primary or secondary batteries are the power source for a wide range of portable electronics products, such as notebook computers, video cameras and mobile phones. To ensure long usage times and customer satisfaction the battery pack should be able to provide a constant power for the longest time possible.

It can be measured that the output voltage of a battery will drop over time (Fig a). The rate of voltage decay depends on a number of factors including duty cycle, chemistry type, battery age and ambient temperature.

So to keep the device powered for the longest possible time the battery must be able to provide a stable power output regardless of output voltage (Fig c). In order to maintain a constant power the output current will need to increase over time to compensate for the reducing voltage (Fig b).

Operating the PEL-5000G series electronic load in CP mode is ideal for testing the characteristics of a battery. This is because as the battery voltage drops the load current will automatically increase in order to keep the CP setting. By logging sink values against time the test engineer can also measure the battery's energy capacity at various discharge rates.

The PEL-5000G series also features an adjustable Load OFF setting. This allows a voltage level to be set so that the electronic load automatically stops sinking power upon reaching this preset voltage. This can be used to ensure the battery is not subjected to a damaging deep discharge.

Along with static operation the load can also be operated dynamically in CP mode. The dynamic functions allow the ramp, fall and plateau times to be adjusted between 2 levels of power. This capability means that “real world” loads can be more accurately simulated. For example the dynamic mode could be used to test the performance of a battery that is required to provide power pulses to transmit data from a radio frequency terminal.

Constant power mode application

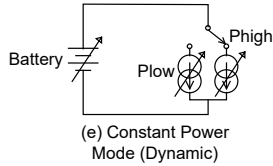
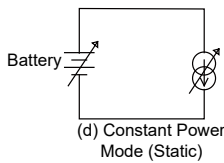
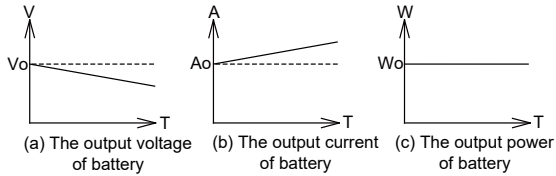

Applications with current limiting or power limiting function CV mode operation (charging device)

Background	Operating in the current-limiting CV mode, the PEL-5000G series can limit current or power when operating at a Constant voltage load. It is especially suitable for charging piles, Constant current sources and other power product testing applications.
Operation method	<ul style="list-style-type: none">• Connect the DUT to the LOAD INPUT terminal• Switch the electronic load to CC Mode or CP Mode first, and press the Preset key to set the current limit point or power limit point.• Press the Limit key, and “Add CV” will appear on the LCD display. At this time, after setting the CV value to be set, press START KEY to start the test.• If you need to modify the current limit or power limit during the test, you can change the current limit or power limit after pressing the Preset button again.• If you need to change the CV test point during the test, press the Limit button again, and “Add CV” will appear on the LCD screen again. At this time, the CV setting value can be changed.• Finally, press STOP KEY to stop the test.
Remote control CV + current limit or power limit	
For example	<ul style="list-style-type: none">• REMOTE (Set up remote control)• MODE CC or CP (Set to CC or CP mode)• CC HIGH 20 or CP HIGH 2000 (Set current limit to 20A or limit power 2000W)• LIM ADDCV VOLT 50 (Set the Constant

voltage to 50V)

- LIM ADDCV ON (Start testing CV+ current limit or power limit mode)
- MEAS: CURR? (Read the current value of the electronic load)
- MEAS: VOLT? (Read the voltage value of the electronic load)
- LIM ADDCV CURR 25 (Modify the current limit to 25A)
- LIM ADDCV POW 2500 (Modify the power limit point to 2500W)
- LIM ADDCV VOLT 40 (Modify the Constant voltage to 40V)
- LIM ADDCV OFF (Stop testing CV+ current limit or power limit mode)

CV + Current Limit mode of operation application

Background

When operating in CV + Current Limit mode, PEL-5000G series at the same time as a Constant Current and Constant Voltage Load, as shown in Fig below.

When operating at Constant Current (CC) load, PEL-5000G series electronic load to Voltage source (VM) Constant Current load (I) and keep Constant Voltage.

When operating at Constant Voltage Load on, the VM is greater than V, Input current changes its input voltage is keep fixed.

When the VM voltage is less than equal to the set voltage CV, the load does not sink current.

Operation Way:

1. Load input terminals are connected to the DUT.
2. Change to CC mode and setting CC current setting.
3. Press Limit key to setting the CV voltage and the display will show "Add.CV".
4. Press Start key to start up the CV + Current Limit test, and press "STOP" key to stop CV + Current Limit test.

CV + Current Limit mode operation application

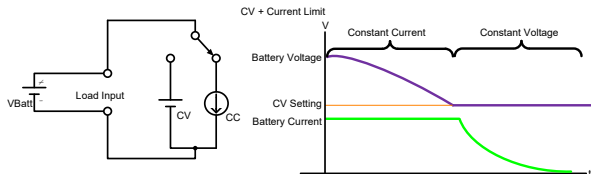

Remote Control CV + Current Limit

REMOTE	(Set Remote Control)
MODE CC	(Setting CC mode)
CC: HIGH 20	(Setting load on current 20A)
LIM: ADDCV:VOLT 50	(Setting constant Voltage is 50V)
LIM: ADDCV ON	(start test CV + Current Limit mode)
MEAS: CURR?	(Read current value)
MEAS: VOLT?	(Read voltage value)
LIM: ADDCV OFF	(Stop test CV + Current Limit mode)

CV + Power Limit mode of operation application

Background When operating in CV + Power Limit mode, PEL-5000G series at the same time as a Constant Power and constant Voltage Load, as shown in Fig below.

When operating at Constant Power (CP) load, PEL-5000G series electronic load provides specified power, independent Constant Voltage source (VM) is output voltage.

When operating at Constant Voltage Load on, the VM is greater than V, Input power changes its input voltage is keep fixed.

When the VM voltage is less than equal to the set voltage CV, the load does not sink current.

Operation Way:

1. Load input terminals are connected to the DUT
2. Change to CP mode and setting CP power setting.
3. Press Limit key to setting the CV voltage and the display will show “Add.CV”.
4. Press START key to start up the CV + Power Limit test, and press “Stop” key to stop CV + Power Limit test.

CV + Power Limit mode operation application

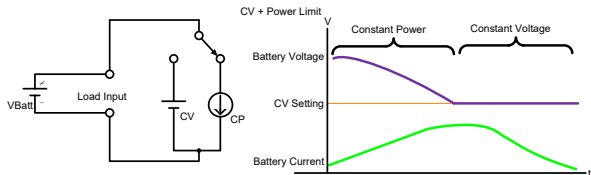

Remote Control CV + Power Limit

REMOTE	(Set Remote Control)
MODE CP	(Setting CP mode)
CP: HIGH 100	(Setting load on current 100W)
LIM: ADDCV:VOLT 50	(Setting constant Voltage is 50V)
LIM: ADDCV ON	(start test CV + Power Limit mode)
MEAS: POW?	(Read power value)
MEAS: VOLT?	(Read voltage value)
LIM: ADDCV OFF	(Stop test CV + Power Limit mode)

Constant current source operating

Background PEL-5000G high-power electronic load can be used as a constant current source when used in series with a constant voltage source for charging the battery or other applications as shown in Fig below.

constant current source connection

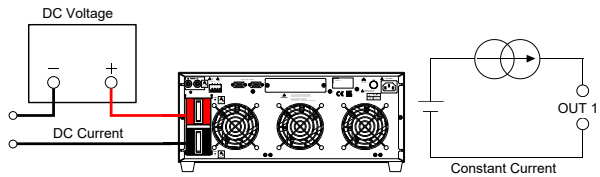

Zero-Volt loading application

Background

As shown in Fig below, the electronic load can be connected in series with a DC voltage source which output voltage greater than 10V. so that the device under test that are connected to the electronic load can be operated down to a Zero-Volt condition, the DC voltage source provides the minimum 10V operating voltage required by the Electronic load. This application is suitable for low voltage Battery cell with high discharge current testing

Zero-Volt loading connection

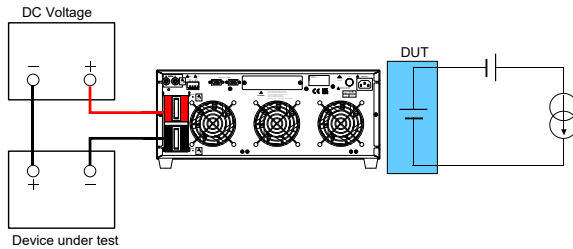

Parallel operation

Background

It is possible to operate load in parallel if the power and/or current capability of a single PEL-5000G series load is not sufficient.

The positive and negative outputs of the power supply are connected individually to each load module as shown in the figure below. The setting is made at each individual load module. The total load current is the sum of the load currents being taken by each load.

While in static mode the load modules can be set to operate in CC, CR or CP. When using multiple loads to sink power from a single DC Source it is not permissible to operate in dynamic mode.



Note

- The electronic load only may carry on the parallel operation under the fixed electric current Pattern.
- The electronic load do not use under series connection.

PEL-5000G series load parallel operation

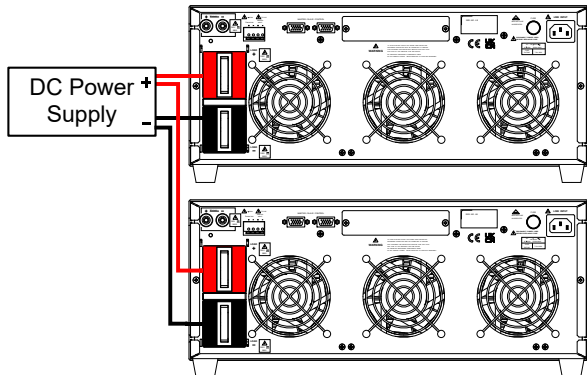

Power Supply OCP testing

- OCP Manual control
1. Press Limit key function to setting I_Hi & I_Lo.
 2. Setting OCP test, press OCP key to the next step.



3. Setting start load current 0A, press OCP key to the next step.



4. Setting step load current 0.05A, press OCP key to the next step.



5. Setting stop load current 5A, press OCP key to the next step.



6. Setting OCP VTH 6.000V, press OCP key to the next step.



7. Press Start/Stop key.
-

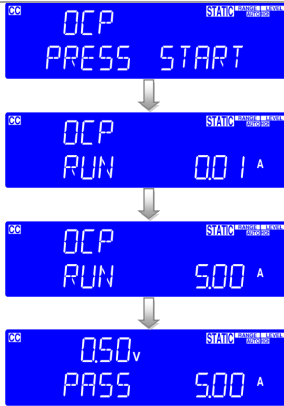

8. The UUT's output voltage drop-out lower than the threshold voltage (V_{th} setting), and the OCP trip point is between I_{Hi} and I_{Lo} limitation, then middle 5 digits LCD display will shows "PASS", otherwise shows "FAIL".



Remote control OCP example

REMOTE	(Set Remote)
TCONFIG OCP	(Set OCP test)
OCP:START 0.1	(Set start load current 0.1A)
OCP:STEP 0.01	(Set step load current 0.01A)
OCP:STOP 2	(Set stop load current 2A)
VTH 3.0	(Set OCP VTH 3.0V)
IL 0	(Set current low limit 0A)
IH 2	(Set current high limit 2A)
NGENABLE ON	(Set NG Enable ON)
START	(Start OCP testing)
TESTING?	(Ask Testing? 1: Testing, 0: Testing End)
NG?	(Ask PASS/FAIL?, 0: PASS, 1: FAIL)
OCP?	(Ask OCP current value)
STOP	(Stop OCP testing)

Power Supply OPP testing

OCV Manual control 1. Press Limit key function to setting W_Hi & W_Lo.

2. Setting OPP test, press OPP key to the next step.



3. Setting start load current 0W, press OPP key to the next step.



4. Setting step load current 0.5W, press OPP key to the next step.



5. Setting stop load current 100W, press OPP key to the next step.



6. Setting OPP VTH 6.000V, press OPP key to the next step.



7. Press Start/Stop key.
-

OPP
PRESS START

OPP
RUN 00W

OPP
RUN 1000W

0.50V
PASS 1000W

8. The UUT's output voltage drop-out lower than the threshold voltage (V_{th} setting), and the OPP trip point is between W_{Hi} and W_{Lo} limitation, then right 5 digits LCD display will shows "PASS", otherwise shows "FAIL".

5.000V
FAIL 1000W

Remote control OPP example

REMOTE	(Set Remote)
TCONFIG OPP	(Set OPP test)
OPP:START 3	(Set start load watt 3W)
OPP:STEP 1	(Set step load watt 1W)
OPP:STOP 5	(Set stop load watt 5W)
VTH 3.0	(Set OPP VTH 3.0V)
WL 0	(Set watt low limit 0W)
WH 5	(Set watt high limit 5W)
NGENABLE ON	(Set NG Enable ON)
START	(Start OPP testing)
TESTING?	(Ask Testing? 1: Testing, 0: Testing End)
NG?	(Ask PASS/FAIL?, 0: PASS, 1: FAIL)
OPP?	(Ask OPP watt value)
STOP	(Stop OPP testing)

SHORT testing

OCP Manual control

1. Setting SHORT test, press Short key to the next step.



2. Press UP key, setting Short time to 10000ms. Press Short key to the next Step.



3. Press down key, setting V-Hi voltage to 1.00V. Press Short key to the next Step.



4. Press down key, setting V-Lo voltage to 0V, press Short key to the next step.



5. Press Start/Stop key.

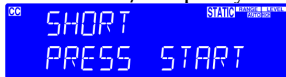

6. Short test is finished, the UUT's drop voltage is between V_Hi and V_Lo limitation, then middle 5 digits LCD display will show "PASS".



7. The UUT's not drop voltage is between V_Hi and V_Lo limitation, LCD display will show "FAIL".



Remote control SHORT example

REMOTE	(Set Remote)
TCONFIG SHORT	(Set SHORT test)
STIME 1	(Set short time 1ms)
START	(Start SHORT testing)
TESTING?	(Ask Testing? 1: Testing, 0: Testing End)
STOP	(Stop SHORT test)

Battery discharge test

There are 4 types battery discharge for the battery discharge application.

Disch CC/ Disch CP measure discharge capacity

User option mode CC or CP mode, firstly, Setting UVP (under voltage protect = stop discharge voltage), testing LOAD ON, when battery voltage less than UVP LOAD OFF Display total discharge capacity AH/WH.

Please refer to the page 64 battery discharge test item operating.

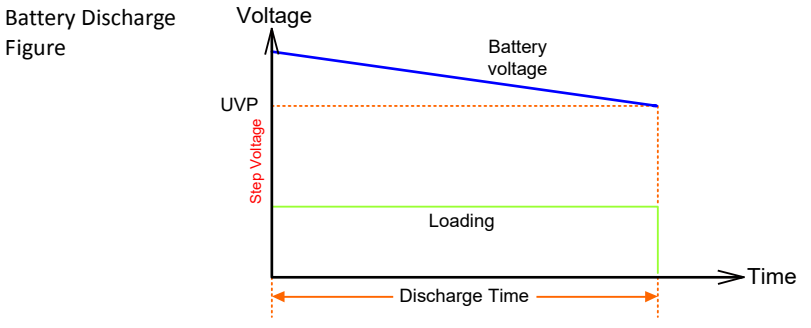

CV + Current Limit

Please refer to the page 177 CV + Current Limit mode of operation application.

CV + Power Limit

Please refer to the page 179 CV + Power Limit mode of operation application

Operation method: Disch CC/ Disch CP can be operated manually and REMOTE, manual operation instructions:

Disch CC/ Disch CP: Setting BATT: CC or BATT: CP, setting BATT:

UVP, setting stop discharge time BATT: TIME, setting stop discharge capacity BATT: AH or BATT: WH, then "BATT:TEST ON" command start testing, when battery voltage less than UVP value then LOAD OFF, on behalf of the end of the test, When it ends LOAD remote will show "OK,XXXXX", XXXXX representative total discharge capacity: AH/ WH.

Example	When Disch CC	When Disch CP
	BATT: CC 2.34	BATT: CP 2.34
	BATT: UVP 12.0	BATT: UVP 12.0
	BATT: TIME 6000	BATT: TIME 6000
	BATT: AH 999	BATT: WH 999
	BATT: TEST ON	BATT: TEST ON

Abnormal testing of power supply

Including AC/ DC, DC/ DC power supply, adapter/ charger these products are not only to supply a stable voltage or current, but also need to be able to protect the abnormal situation in order to ensure safety, there will not be overheating or high temperature due to high current, and even cause a fire and other hazards.

Short, over current, over power are abnormal condition, and these anomalies are typically 125% to 150% of the normal rating, or even 200%, therefore, in the test to test these abnormal conditions, you must choose to meet the maximum current value and the maximum power value of the electronic load to perform the test.



Message displayed on the PEL-5006G-150-600's screen

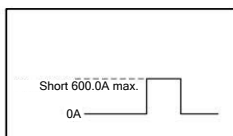
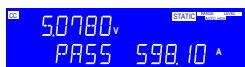

PEL-5006G-150-600 Turbo mode OFF
Short test setting

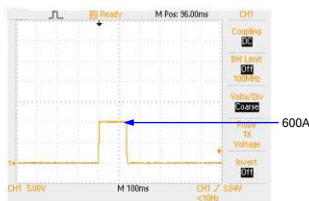

PEL-5006G-150-600 Turbo mode OFF
Short real test waveform

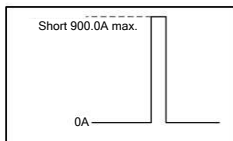
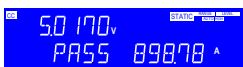

PEL-5006G-150-600 Turbo mode ON
Short test setting

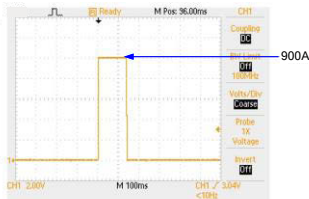

PEL-5006G-150-600 Turbo mode ON
Short real test waveform

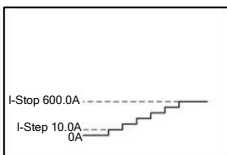

PEL-5006G-150-600 Turbo mode OFF
Setting OCP Istep 10A, Istop 600.0A

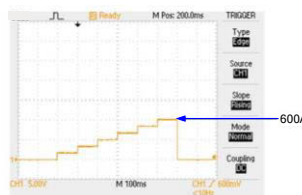

PEL-5006G-150-600 Turbo mode OFF
OCP Istep 10A, Istop 600.0A real test waveform

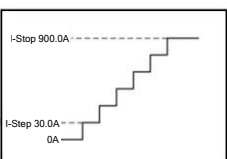
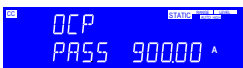

PEL-5006G-150-600 Turbo mode ON
Setting OCP Istep 30A, Istop 900.0A

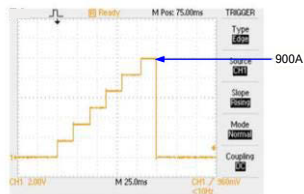

PEL-5006G-150-600 Turbo mode ON
OCP Istep 30A, Istop 900.0A real test waveform

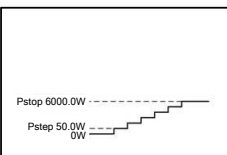

PEL-5006G-150-600 Turbo mode OFF
Setting OPP Pstep 50W, Pstop 6000.0W

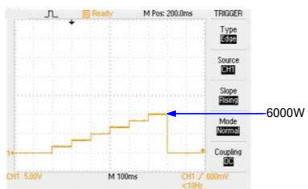

PEL-5006G-150-600 Turbo mode OFF
OPP Pstep 50W, Pstop 6000.0W real test waveform

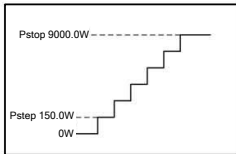
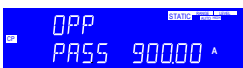

PEL-5006G-150-600 Turbo mode ON
Setting OPP Pstep 150W, Pstop 9000.0W

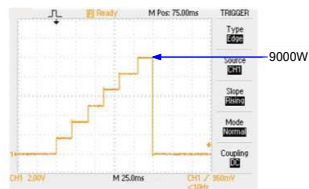

PEL-5006G-150-600 Turbo mode ON
OPP Pstep 150W, Pstop 9000.0W real test waveform

The power supply products must respond to the corresponding protection function, however, the abnormal situation is quite short time, for the test of these abnormal conditions, GW Instek's PEL-5000G series electronic load can raise the electronic load current and power in the new Turbo mode. For example, PEL-5006G-150-600 150V/ 600A/ 6000W in the new turbo mode, can increase to 900A and 9000W electronic load within 2 sec., so that when verifying the power products in the abnormal test conditions, PEL-5000G series electronic load are with greater test verification Capability, besides, PEL-5000G series built-in measurement circuit can also measure the actual trip current value and protection response time in the short-circuit abnormal conditions.

BMS Protective device

Lithium batteries are widely used in a variety of electronic products and electric vehicles and other devices. In order to protect the lithium battery from catching fire, exploding or any other dangerous condition, the lithium battery must be designed with a battery management system (BMS) protection circuit.

The BMS ensures the charging voltage does not exceed the maximum safe value of the lithium battery (over voltage protection or OVP) during charge cycles. It also monitors discharge to ensure battery does short-circuit or exceed its rated current (over current protection or OCP). Finally, internal battery and cell temperatures are monitored for over or under temperature protection (OTP/UTP).



Battery BMS Board



Turbo mode ON
BMS ON
Short function test

Displayed message
on the PEL-5006G-
150-600's screen



The PEL-5000G series BMS test function for lithium batteries includes short circuit and over current protection modes, which provide a quick, easy and accurate test solution. For BMS short-circuit protection, there is about 1.5 times more current available for OCP current testing that needs immediate (μs level) protection action function, use PEL-5006G-150-600 up to 900A current load, in the process of high current pull to BMS rated short circuit current, it can verify BMS short circuit protection can do correct action.

In addition, the PEL-5000G series electronic load can also detect the

actual operating current value and operating time of the BMS short circuit protection action, that is, the actual operating current value and operating time when the BMS internal MOSFET switch is turned off.

For BMS overcurrent protection, it is between normal operating current and short-circuit current protection, generally higher than 125% of OCP current, it needs fast (about several hundred mS level) protection action.

PEL-5000G series BMS overcurrent (overcurrent during charging and overcurrent during discharge) protection test system with electronic load pull, then confirm whether BMS overcurrent protection is active, when BMS overcurrent protection is not active, increase load current (I Step). Then, confirm whether the OCP of the BMS is active, and continue the process until the BMS OCP action occurs. Therefore, the BMS OCP test can be scanned by gradually increasing the load current to obtain the current point and action reaction time of the BMS overcurrent protection.

- BMS short circuit, overcharge current, over discharge current protection principle the BMS circuit protection principle is as shown in the figure below. It is to protect the battery by turning off the MOSFET (loop current = 0A).

In the BMS, the MOSFET switch is bidirectional. In the normal status, the two switches are ON. Since the two MOSFET switches have the $R_{ds\ ON}$ resistance, current flow will cause a Voltage drop. Battery BMS is used this feature to detect charge and discharge currents.

The MOSFET switching status shown in the figure below is the over-discharge current status. The IC's 3rd pin control MOSFET is ON, this time the discharge switch is OFF (controlled by IC pin 1).

When the BMS detects a short circuit, over discharge current or low battery voltage, it will turn off the discharge switch to protect the battery.

When the BMS detects an overcharge current or a battery overvoltage, it will turn off the charge switch to protect the

battery.

When the battery is accidentally short-circuited or over-current, when the voltage on the second pin of the IC (the voltage division of the MOSFET's threshold voltage on-resistance) is greater than the over-current detection voltage, the discharge terminal of the first pin of the IC outputs a low level, the discharging MOSFET is turned off, and stops Discharge.

Figure A

BMS internal architecture

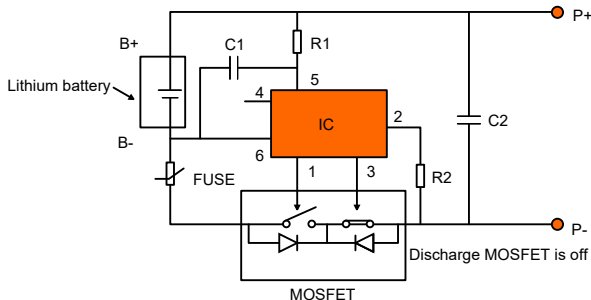

- Short-circuit protection (SHORT) test method:
Power supply (PS) & LOAD connection is shown in figure A, load test procedure is shown in figure C.

In the short-circuit protection test mode, the electronic load will load the maximum current value of the model (for example, 600A for PEL-5006G-150-600 or 900A for Turbo ON). At the same time, the timer is started to calculate the actual time flowing through the BMS.



Note

This time refers to the time between the set threshold current I_{th} to the BMS action MOSEFT switch OFF, that is, the time lower than the set threshold current I_{th} .

in addition, the electronic load will measure the actual maximum short circuit current value, Figure D is 4000 mAh mobile power uses the PEL-5006G-150-600 BMS test oscilloscope current waveform (Figure D left figure) and the electronic load power meter to show the short circuit maximum actual current and short circuit protection reaction time (Figure D right figure).

Figure B

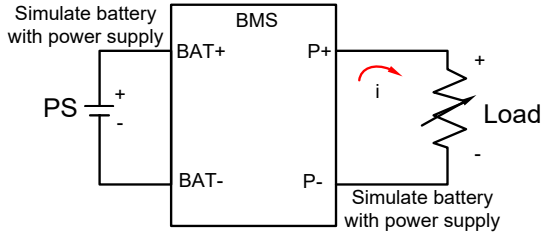

SHORT Protection Test Procedure

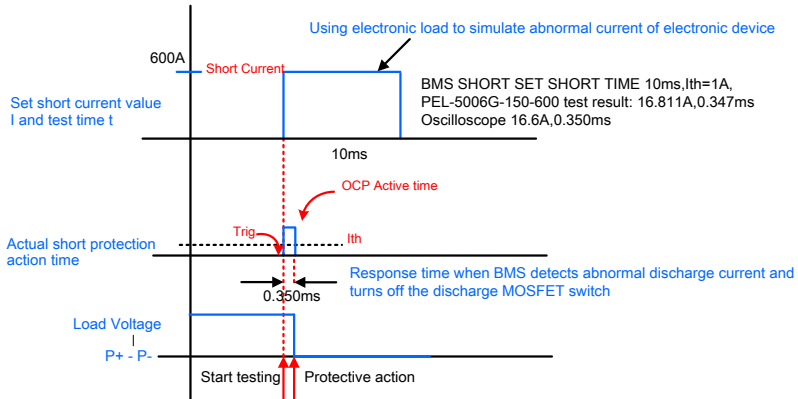
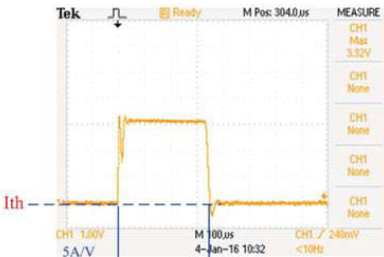

Figure C PEL-5006G-150-600 short-circuit current test procedure



BMS SHORT: SET SHORT TIME 10ms, Ith = 1A, PEL-5006G-150-600 test result: 16.811A, 0.347ms Oscilloscope: 16.6A, 0.350ms

Short-circuit protection time is about 0.350ms

Figure D 4000mAh Power Bank Actual Short Circuit Test Waveform

- Overcharge Current Protection (OCCP) test method:
The test method is divided into single pulse and continuous step pulse. Single pulse can be used for rapid test. It can be used for a

large number of fast tests suitable for the production line. Continuous step pulse can be used to scan the actual over current protection point. Suitable for research and development that needs accurate point. The power supply (PS) & LOAD connection and test procedures are shown in Figure E.

In the single-pulse overcurrent protection test mode, the electronic load will be pulled to the set current value (for example, PEL-5006G-150-600 is the current value between 0~600A or 900A when Turbo is ON), at this time, the electronic load measures the actual maximum overcurrent protection value and the overcurrent response time value. Figure F is the PEL-5006G-150-600 single pulse current BMS overcharge current test program diagram, Figure G is the actual test result, the left picture is the oscilloscope Current waveform when BMS overcharge current protection. The figure on the right shows the actual test overcharge current value and protection reaction time of the PEL-5006G-150-600 BMS.

- The overcurrent protection test mode of continuous STEP pulse is similar to the single pulse mode. In addition to the initial current setting, the continuous STEP pulse mode increases the time of each STEP, the current increased by each STEP and the current value of the final STEP. Figure H is the PEL-5006G-150-600 single pulse current BMS overcharge current test program diagram. Figure I is the actual test result, the left picture is the oscilloscope current waveform diagram when BMS overcharge current protection, the right picture is the actual test overcharge current value of PEL-5006G-150-600 BMS and protect the reaction time.
- In continuous STEP pulse mode, the maximum overcurrent protection value and overcurrent action reaction time value measured by the electronic load are the Measurement results under each STEP. For example, if ISTART is set to 1.000A, OCT TSTEP is 500ms, OCP ISTEP is 0.1A, OCP ISTOP is 5.000A, the measurement process is the electronic load sinks current 1.000A and test whether the battery BMS operates at 500ms. If it is, it will measure the action current value and the action reaction time. If the battery BMS is no action under 1.000A; the electronic load will increase to 1.100A according to ISTEP setting and test whether it

operates at 500ms. If it is, it will measure the operating voltage value and action time at 1.100A, if the battery BMS is no action at 1.100A. The load Current is increased to 1.200A in the above manner until the final test voltage value of the battery BMS test is 5.000A.

Refer to the actual operation example of PEL-5000G series

Figure E
Equivalent
simulation of BMS
charging

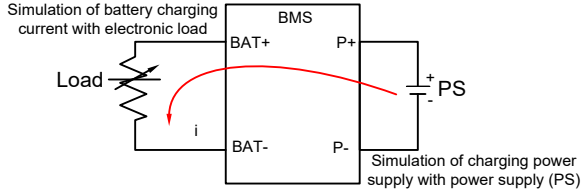

- Single Pulse: Used during quick test

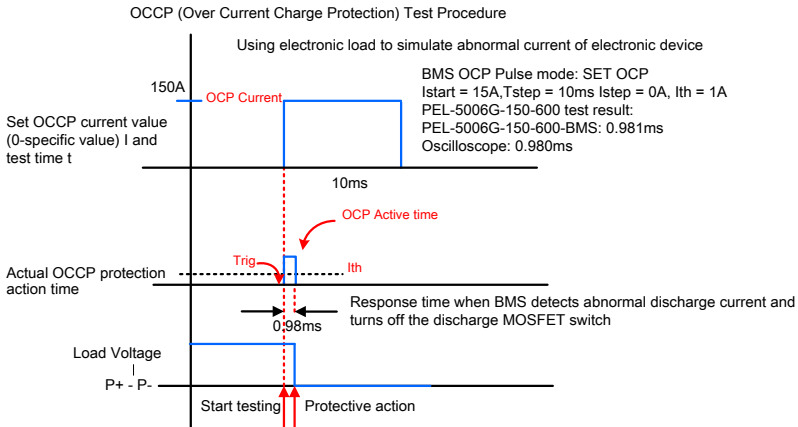

Figure F PEL-5006G-150-600 BMS overcharge flow test program diagram (single pulse)



BMS OCP Pulse mode: SET OCP
 Istart = 15A, Tstep = 10ms, Istep = 0A,
 Ith = 1A
 PEL-5006G-150-600 test result:
 PEL-5006G-150-600 BMS: 0.981ms
 Oscilloscope: 0.980ms

Over current protection time is about 0.98ms

Figure G PEL-5006G-150-600 BMS overcharge flow test program diagram (single pulse)

- **Continuous Step Pulse:** Use when scanning the actual overcurrent protection point during charging.

OCCP (Over Current Charge Protection) Test Procedure

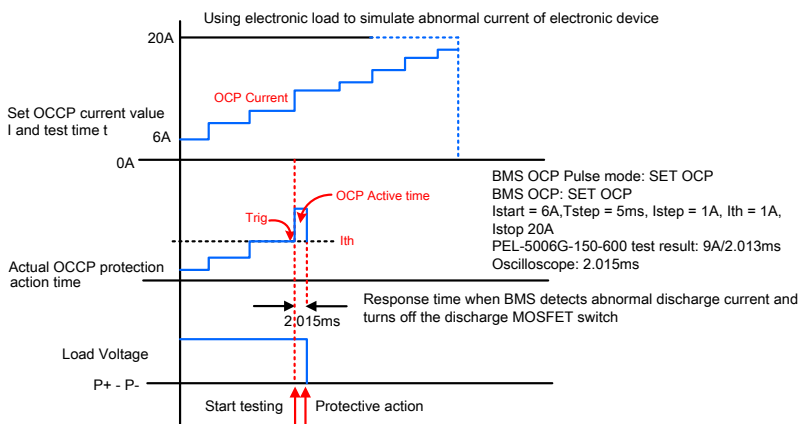
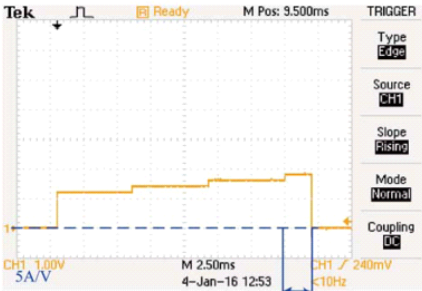

Figure H PEL-5006G-150-600 overcharge flow test program diagram (continuous STEP pulse)



BMS OCP Pulse mode:
 BMS OCP: SET OCP
 Istart = 6A, Tstep = 5ms, Istep = 1A, Ith = 1A,
 Istep = 20A
 PEL-5006G-150-600 test result: 9A/2.013ms
 Oscilloscope: 2.015ms

IA

Over current protection time is about 2.015ms

Figure I PEL-5006G-150-600 BMS overcharge flow test program diagram (single pulse)

- Over current discharge protection (OCDP) test method: Power supply (PS) & LOAD connection and test procedures are shown in Figure J.

Figure J
 Equivalent simulation of BMS discharge

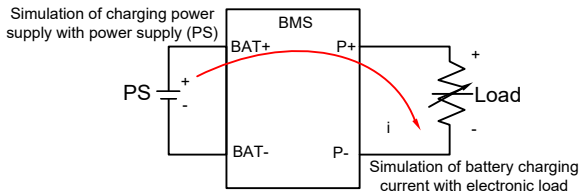

- Single Pulse: Used during quick test OCDP (Over Current Discharge Protection) Test Procedure. The PEL-5006G-150-600 single pulse current BMS over discharge current test procedure is similar to the BMS overcharge current test. The PEL-5006G-150-600 BMS function can actually test the overcharge current value and the protection reaction time.
- Continuous Step Pulse: Used when the actual overcurrent protection point during scan discharge OCDP (Over Current Discharge Protection) test procedure. The PEL-5006G-150-600 continuous pulse current BMS over discharge current test procedure is similar to the BMS overcharge current test. The PEL-5006G-150-600 BMS function can actually test the overcharge current value and reaction time.
- The function and actual action response of the battery BMS have

been explained in detail. The battery BMS can immediately provide protection and disconnection measures for the abnormal voltage, current, temperature and other conditions of the battery to avoid the occurrence of danger, because the battery BMS is a safety measure that must be 100% full-featured test verification that security can be ensure, although the test and verification for the battery BMS can use the oscilloscope to measure the current value and action response time of the BMS action, it is undoubted that the oscilloscope can be tested in detail during the development stage, but in a mass production stage, there is a need for rapid and complete testing that there is a limit on capacity production . For this difficulty, GW Instek integrates the BMS test into the PEL-5000G series electronic load. In addition to the functions of the normal PEL-5000G series, the set test current required for battery BMS testing is increased. Both the current action value and the action response timer are integrated into the PEL-5000G BMS function, allowing a large number of quick tests to verify that the battery BMS becomes a reliable, accurate and fast method.

To test BMS over-current protection, the PEL-5006G-150-600 load starts to sink current (I start), then checks whether the BMS over-current protection is active. If the BMS over-current protection is not active, the load starts to increase the load current (I Step) and checks whether the BMS OCP is responds. This process continues until the BMS OCP activates. Thus, the BMS OCP test can determine both OCP function current trip level and response time.

Model 9923 current waveform generator

The 9923 programmable DC load current waveform generator is designed to simulate the actual discharge current waveforms that occur when discharging batteries.

The use of batteries to power a multitude of portable devices such as mobile phones, tablets, laptops, etc. as well as mobility products like electric bicycles, scooters and cars has become widespread.

During actual operation in these applications, the battery output current changes dynamically with the operation of the product. In order to assess battery life, capacity and any time related characteristics that may occur during use, it is important to test the batteries using actual battery load current waveforms under both general and worst case conditions.

To implement these irregular load current waveforms on an electronic DC load, there are two methods that can be used:

The first method relies on the use of a digital storage oscilloscope and a current measuring device such as a current probe or shunt to capture the actual battery discharge current waveform under real world conditions. Once captured, the next step is to take this waveform data and transfer it to an arbitrary waveform generator.

1. Use the arbitrary waveform generator to edit the load current waveforms manually as needed.
2. The output of the arbitrary waveform generator is then sent to the analog input of the DC load.

The second method is to use the new 9923 load current generator which can be installed on a wide range of GW's DC electronic loads. The generator output is connected to the DC load's analog input using the provided BNC cable and eliminates the need for a separate arbitrary generator. Use either manual waveform data editing or import and oscilloscope waveform to generate simulated load current waveform on the DC load.

The 9923 load current waveform plug-in generator can be installed on a wide selection of DC loads, including high power electronic loads such as the PEL-5000G series.

PC application software is provided with the 9923 generator to allow waveform editing, oscilloscope waveform download and other programming functions.

The DC Load Current Waveform Generator supports up to 2048 steps per timing sequence output voltage and the ability to cycle this waveform up to 9999 times. With the included 9923 application software, the user can generate the desired load current waveform. The output of the Generator is connected to the ANALOG INPUT terminal of the electronic load cause it to sink the specified current waveform. Refer to the he current sink example shown in Figure 1. The 9923 technical specification is as shown below. A generator output voltage of 10V is equal to the maximum current value of the electronic load used. An output of 5V is equal to 1/2 the maximum current specification of the load, and so on.

Figure 1
Load Current
Waveform

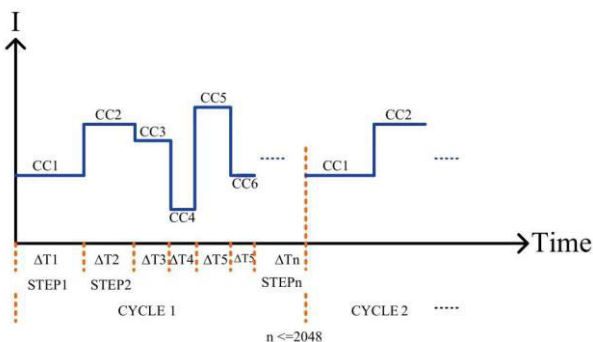

9923 Current Waveform generator application software

The included 9923 Load Current Waveform Generator Application Software may be used to edit waveforms that provide the user with a variety of real load conditions on his electronic load. Up to 2048 steps in each timing sequence can be edited.

The timing sequence programmed can be cycled up to 9999 times. The minimum available time for each timing step is 50us and the maximum length of a sequence is about 130,000 seconds or about 36 hours. Using the electronic load's measurement function, the voltage, current and power status when sinking current can be monitored.

In addition to manually editing the required current waveform, the user can also use an oscilloscope to capture and store the actual current waveform using a comma separated value file (*.csv). The 9923 application software can read this current waveform file and then download it to the 9923 Load Current Waveform Generator for Electronic load simulation use.

Typical applications

1. Simulation of Battery discharge in real-world applications (Loads may be notebook computers, electric vehicles, electric scooter etc.) to simulate a variety of dynamic load sink current waveforms and to provide a number of dynamic current load level simulations.
2. Testing of power supply load modulation.
3. Simulation of fuel cell life cycle testing.
 - a. Use the self-editing load current waveform to simulate the method of reproduction:

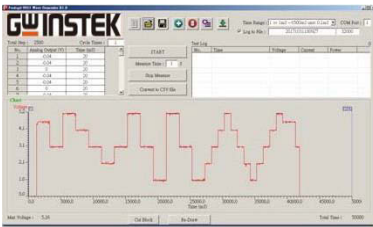

Edit by 9923 application software

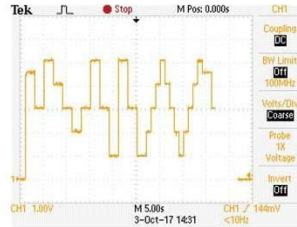

Regeneration the load current waveform

- b. Use the oscilloscope's load current waveform (*.csv), after it has been processed by the 9923 application software, then download to the 9923 to simulate current:

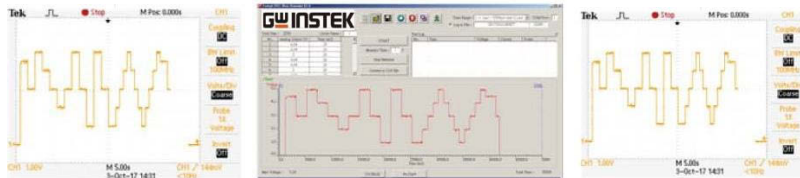

Actual load current waveform

Edit by 9923 application software

Regeneration the load current waveform

- c. Time Range: Select to use the time specification
User can set Time Range 0~3 or use the oscilloscope to store the actual current waveform (*.CSV), by means of the 9923 application software to read the actual current waveform file (*.CSV) and then download to 9923 Current Waveform Generator to proceed with Electronic load simulation.

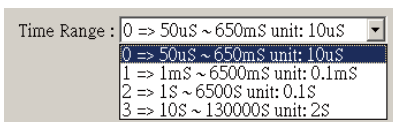



- d. COM Port: Set RS-232 connection COM Port.

- e.  New File: Open a new file.

- f.  Open old File:

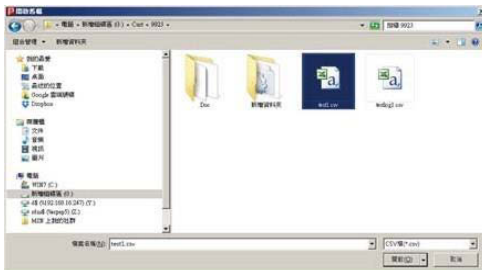

Load the existing test step file, or load the oscilloscope CSV format file using the 9923 application software to read the actual current waveform file (*.csv) and then download it to 9923 Current Waveform Generator to proceed Electronic load simulation.

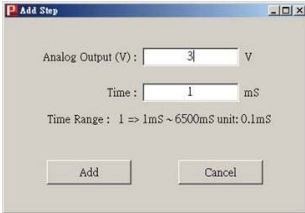

- g.  Save to File: Save the test step setting values to the specified file.
- h.  Addition: Add a test step after the last test step, maximum up to 2048 test steps. The program will display and error message if there are more than 2048.



1. Analog Output (V): Set the analog output voltage.
2. Time: Set the output voltage time, the unit changes according to Time Range.
3. Add: Make sure to add a new one.
4. Cancel: Cancel setting.

- i.  Delete: Delete a test step.
- j.  Insert : Insert a test step after the currently selected test step, maximum up to 2048 test steps.

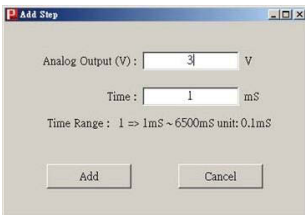

1. Analog Output (V): Set the analog output voltage.
2. Time: Set the load time, the unit changes according to Time Range.
3. Insert: Make sure to insert a new one.
4. Cancel: Cancel setting.

- k.  Download to Load : Download test step to 9923.
- l. Test Step List: Show all test step setting data.
- Double-click to edit the column, press [Enter] to set. If [Enter] is not pressed, the program will not make changes.
 - When the modification is complete, the timing diagram will change and will automatically move to the next step to provide the changes.

- When pressing [Enter] in the last step, the program will automatically go to the next channel to allow more changes.
- m. Cycle Times: Set the number of cycles, maximum up to 9999 times
- n. Log to File: Select whether to save file only and not appear in the list.



Check the Log to file box and the program will automatically generate the serial number YYYYMMDDhhmmss. The user can also change this field manually. This field will be used to create a log to file name, followed by a 0001 count number. The test log file will be stored in the TestLog folder.

- o. Test Step List: Show all test steps setting data.
- Double-click to edit the column, press [Enter] to set. If [Enter] is not pressed, the program will not make changes.
 - When the modification is complete, the timing diagram will change and will automatically move to the next step.
 - When pressing [Enter] in the last step, the program will automatically go to the next channel to allow more changes.
- p. Start: Start the test.

First, the PC must be connected to the 9923 to perform an interface connection detection. If the system does not use the 9923 card or has already started and has not restarted LOAD, the system will prompt alert [Please check 9923 card is installed in the Load, then restart the Load.], Press OK to exit the start function, as shown below.

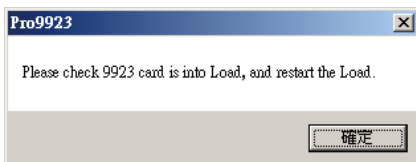

The next step will compare the test steps. 9923 software will not download to the 9923 EEROM if the test steps are the same. The 9923 software will prompt the user whether to download to 9923 if the test steps are not the same. In that case, the system will show a prompt [Have modify. Do you want to download LOAD?], as shown below.



After starting the test, if you set the Measure Time to a value greater than 0, the program measure the voltage, current, power and other information, and recorded in the Test Log according to the time interval set.

- q. Stop: Stop measuring
- r. Chart: Display timing diagram.
- s. ReDraw: Redraw timing diagram.
- t. Cut Block: Delete the data outside the block
- u. Users can adjust the position of Ux and Dx to reduce the amount of data.

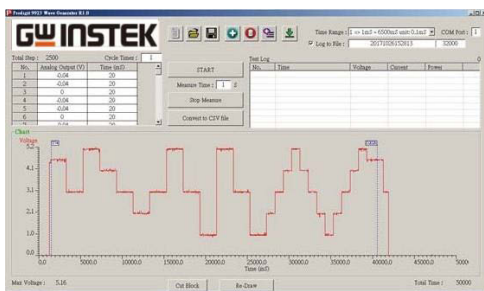

Stand-alone application (no need for a computer connection)

The 9923 supports stand-alone operation as well. In this case, the user need only download the waveform data to the 9923 EEPROM. If there is no need for the application software to record the voltage, current and other information, the computer connection can be removed. The user only has to Press the Start button on the 9923 rear panel itself. The analog output will begin to load according to the edited voltage level and feed the analog input of the timing output voltage signal to the electronic load. Users can also use the Start key terminal connection (External Start key) to connect an appropriate length remote external button if more convenient.

9923 panel diagram

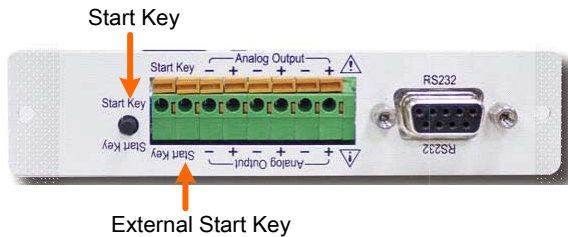

Parallel applications

The 9923 can be applied to multiple parallel loads as needed. Because the 9923 current waveform generator uses the analog input function to control the load current, when the load power or load current is insufficient, you can obtain higher power and current using multiple loads. 9923 supports parallel operation of up to three electronic loads. The 9923 rear panel provides 3 sets of Analog outputs (internal paralleled).

The 9923 Current Waveform Generator Application Software scales corresponding waveform voltage level as the sum of the current of the parallel loads. For example, when 3 sets of PEL-5004G-120-160 1200V/ 160A/ 4000W are required to test 200A; each PEL-5004G-120-160 must allocate 200A current analog input.

This requires $16A / V$, $66.666/16 = 4.166V$. Thus, the 9923 application software voltage must be edited to $4.166V$ and then through the following diagram connected in parallel with three PEL-500G-1200-160.

Each PEL-500G-120-160 will be seen an input voltage level equivalent to a $66.666A$ load current, resulting in a total of $200A$.

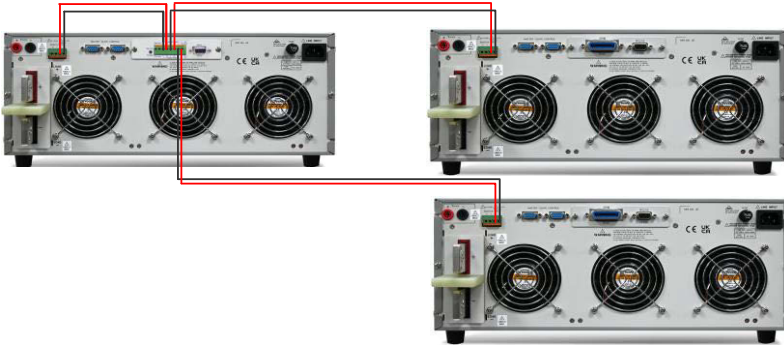

9923 Installation method

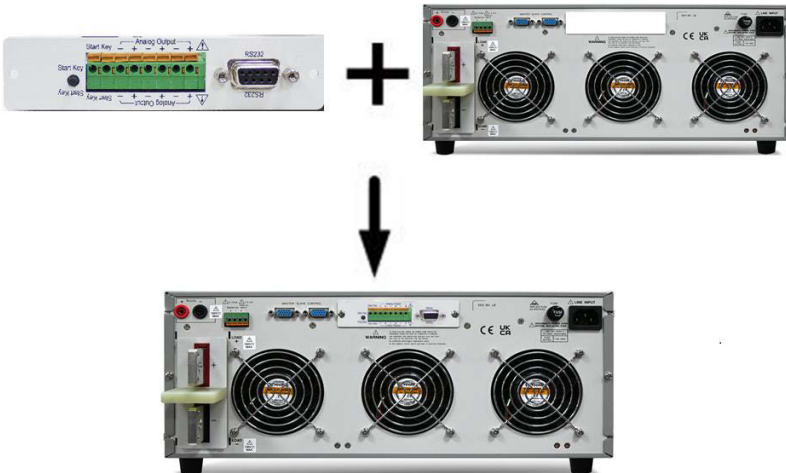

SEQUENCE LOAD (remote only)

SEQUENCE LOAD function, the time sequence can be 2~16 STEP, each STEP must set the load value and time, after starting the test, it will be executed repeatedly according to the set value until the voltage is less than VTH (threshold voltage) value, or received Stop the command to stop the test. During the test, the load value can be modified, and the time is fixed. Apply the TRIG command to trigger and change of the load value. The SEQUENCE LOAD function is only for REMOTE operation. The action mode is shown in Figure 1, the parameters are STEP n=2~16, CC0/CP0, $\Delta T0$, CC1/CP1, $\Delta T1$, ... CC15/CV15, $\Delta T15$, VTH, Time = 10us ~ 999000ms (Time r0: 20us~1000us resolution=10us, this range cannot be set in the first Step, r1: 2 ~ 65535ms, resolution = 1ms, r2: 66 ~ 999Sec resolution = 1Sec).

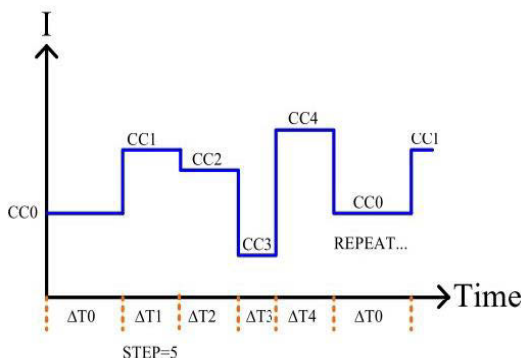

REMOTE SEQUENCE LOAD TEST command

Sequence Load test set command	Note
SEQLD:TYPE{SP}{CC CP}{; NL}	SET CC or CP MODE
SEQLD:TOTSTEP{SP}{n}{; NL}	SET STEP, n=2~16
SEQLD:TIME{n}{SP}{NR1}{; NL}	SET Δ TIME= 0.02~999000ms, n = 0~15
SEQLD:CC{n}{SP}{NR2}{; NL}	SET CURRENT, UNIT: A, n = 0~15

SEQLD:CP{n}{SP}{NR2}{; NL}	SET POWER, UNIT: W, n = 0~15
SEQLD:TRIG{SP}{ON}{; NL}	TRIGGER CHANGE CC/CP VALUE
SEQLD:TEST{SP}{ON OFF}{; NL}	SET START or STOP TEST

PEL-5006G-150-600 (150V/600A, 6KW) Operation example

REMOTE	(Set remote control)
RISE 24	(Set rise slope24A/uS)
FALL 24	(Set fall slope24A/uS)
SEQLD:TYPE CC	(Set CC SEQ MODE)
SEQLD:CC0 30	(Set CC0=30A)
SEQLD:CC?	(Read CC0 value)
SEQLD:TIME0 1000	(Set TIME0=1000mS)
SEQLD:TIME0?	(Read TIME0 value)
SEQLD:CC1 60	(Set CC1=60A)
SEQLD:TIME1 2000	(Set TIME1=2000mS)
SEQLD:CC2 15	(Set CC2=15A)
SEQLD:TIME2 500	(Set TIME2=500mS)
SEQLD:TOTSTEP 3	(Set 3 STEP)
SEQLD:TOTSTEP?	(Read STEP setting)
VTH 1	(Set VTH=1V)
SEQLD:TEST ON	(execute SEQ MODE test)

Actual waveform: (CH1 = Imonitor 60A/V, CH2 = Vin)

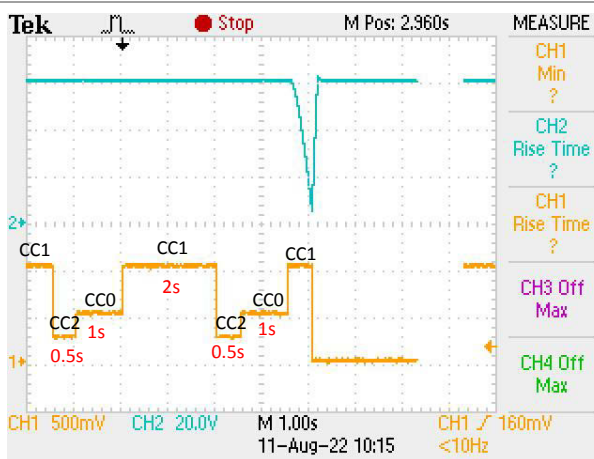

APPENDIX

PEL-5000G Default Settings	217
Replacing the Fuse	220
PEL-5000G Dimensions	221
Terminal Dimensions	222
PEL-5000G series Specifications	223
PEL-5004G-150-400, PEL-5005G-150-500	223
PEL-5006G-150-600, PEL-5004G-600-280	226
PEL-5005G-600-350, PEL-5006G-600-420	229
PEL-5004G-1200-160	233
PEL-5005G-1200-200, PEL-5006G-1200-240	236
Certificate Of Compliance	240
GIPIB programming Example	241
PEL-5000G series USB Instruction	245
PEL-5000G series LAN Instruction	247

PEL-5000G Default Settings

The following default settings are the factory configuration settings for the load.

Model	PEL-5004G-150-400	PEL-5005G-150-500	PEL-5006G-150-600
Item	Initial value		
CC L+Preset	0.000 A	0.000 A	0.000 A
CC H+Preset	0.000 A	0.000 A	0.000 A
CR H+Preset	22500.0Ω	18000.0Ω	15000.0Ω
CR L+Preset	22500.0Ω	18000.0Ω	15000.0Ω
CV H+Preset	150.00 V	150.00 V	150.00 V
CV L+Preset	150.00 V	150.00 V	150.00 V
CP L+Preset	0.00 W	0.0W	0.0W
CP H+Preset	0.00 W	0.0W	0.0W
Model	PEL-5004G-600-280	PEL-5005G-600-350	PEL-5006G-600-420
Item	Initial value		
CC L+Preset	0.000 A	0.000 A	0.000 A
CC H+Preset	0.000 A	0.000 A	0.000 A
CR H+Preset	128568 Ω	102854 Ω	85712 Ω
CR L+Preset	128568 Ω	102854 Ω	85712 Ω
CV H+Preset	600.00 V	600.00 V	600.00 V
CV L+Preset	600.00 V	600.00 V	600.00 V
CP L+Preset	0.00 W	0.0 W	0.0 W
CP H+Preset	0.00 W	0.0 W	0.0 W
Model	PEL-5004G-1200-160	PEL-5005G-1200-200	PEL-5006G-1200-240
Item	Initial value		
CC L+Preset	0.000 A	0.000 A	0.000 A
CC H+Preset	0.000 A	0.000 A	0.000 A
CR H+Preset	450000 Ω	360000 Ω	22500 Ω
CR L+Preset	450000 Ω	360000 Ω	22500 Ω
CV H+Preset	1200.00 V	1200.0 V	1200.0 V
CV L+Preset	1200.00 V	1200.0 V	1200.0 V
CP L+Preset	0.00 W	0.0 W	0.0 W
CP H+Preset	0.00 W	0.0 W	0.0 W
Model	PEL-5004G-150-400	PEL-5005G-150-500	PEL-5006G-150-600
Item	Initial value for Limit		
V_Hi	150.00 V	150.00 V	150.00 V
V_Lo	0.00 V	0.00 V	0.00 V
I_Hi	400.00 A	500.00 A	600.0 A
I_Lo	0.00 A	0.00 A	0.00 A
W_Hi	4000.0 W	5000.0 W	6000.0 W

W_Lo	0.0 W	0.0 W	0.0 W
Model	PEL-5004G-600-280	PEL-5005G-600-350	PEL-5006G-600-420

Item	Initial value for Limit		
V_Hi	600.00 V	600.00 V	600.00 V
V_Lo	0.00 V	0.00 V	0.00 V
I_Hi	280.00 A	350.00 A	420.00 A
I_Lo	0.00 A	0.00 A	0.00 A
W_Hi	4000.0 W	5000.0 W	6000.0 W
W_Lo	0.0 W	0.0 W	0.0 W
Model	PEL-5004G-1200-160	PEL-5005G-1200-200	PEL-5006G-1200-240

Item	Initial value for Limit		
V_Hi	1200.00 V	1200.00 V	1200.00 V
V_Lo	0.00 V	0.00 V	0.00 V
I_Hi	160.00 A	200.00 A	240.00 A
I_Lo	0.00 A	0.00 A	0.00 A
W_Hi	4000 W	5000.0 W	6000.0 W
W_Lo	0.0 W	0.0 W	0.0 W

Model	PEL-5004G-150-400	PEL-5005G-150-500	PEL-5006G-150-600
-------	-------------------	-------------------	-------------------

Item	Initial value for DYN		
T HI	2.000 mS	2.000 mS	2.000 mS
T LO	2.000 mS	2.000 mS	2.000 mS
RISE	0.2560A/uS	0.320A/uS	0.3840A/uS
FALL	0.2560A/uS	0.320A/uS	0.3840A/uS

Model	PEL-5004G-600-280	PEL-5005G-600-350	PEL-5006G-600-420
-------	-------------------	-------------------	-------------------

Item	Initial value for DYN		
T HI	2.000 mS	2.000 mS	2.000 mS
T LO	2.000 mS	2.000 mS	2.000 mS
RISE	0.1792A/uS	0.2240A/uS	0.2688A/uS
FALL	0.1792A/uS	0.2240A/uS	0.2688A/uS

Model	PEL-5004G-1200-160	PEL-5005G-1200-200	PEL-5006G-1200-240
-------	--------------------	--------------------	--------------------

Item	Initial value for DYN		
T HI	2.000 mS	2.000 mS	2.000 mS
T LO	2.000 mS	2.000 mS	2.000 mS
RISE	0.1024A/uS	0.1280A/uS	0.1536A/uS
FALL	0.1024A/uS	0.1280A/uS	0.1536A/uS

Model	PEL-5004G-150-400	PEL-5005G-150-500	PEL-5006G-150-600
-------	-------------------	-------------------	-------------------

Item	Initial value for CONFIG		
SENSE	Auto	Auto	Auto
LD-ON	2.50 V	2.50 V	2.50 V
LD-OFF	1.00 V	1.00 V	1.00 V
+LOAD	+LOAD	+LOAD	+LOAD

Model	PEL-5004G-600-280	PEL-5005G-600-350	PEL-5006G-600-420
Item	Initial value for CONFIG		

SENSE	Auto	Auto	Auto
LD-ON	4.0 V	4.0 V	4.0 V
LD-OFF	0.5 V	0.5 V	0.5 V
+LOAD	+LOAD	+LOAD	+LOAD

Model	PEL-5004G-1200-160	PEL-5005G-1200-200	PEL-5006G-1200-240
Item	Initial value for CONFIG		

SENSE	Auto	Auto	Auto
LD-ON	10.0 V	10.0 V	10.0 V
LD-OFF	5.00 V	5.00 V	5.00 V
+LOAD	+LOAD	+LOAD	+LOAD

Model	All model
Item	Initial value
SHORT	Disable
OPP	Disable
OCP	Disable

Replacing the Fuse

Background

Check the rating of the line fuse and replace it with the correct fuse if necessary. 100V~230V, PEL-5000G series use T5A/250V (5*20mm), The AC line fuse is located left, the AC line receptacles is shown as figure below. Change an appropriate specifications fuse and then reinstall fuse holder and connect the power cord.

PEL-5000G series fuse holder



PEL-5000G Dimensions

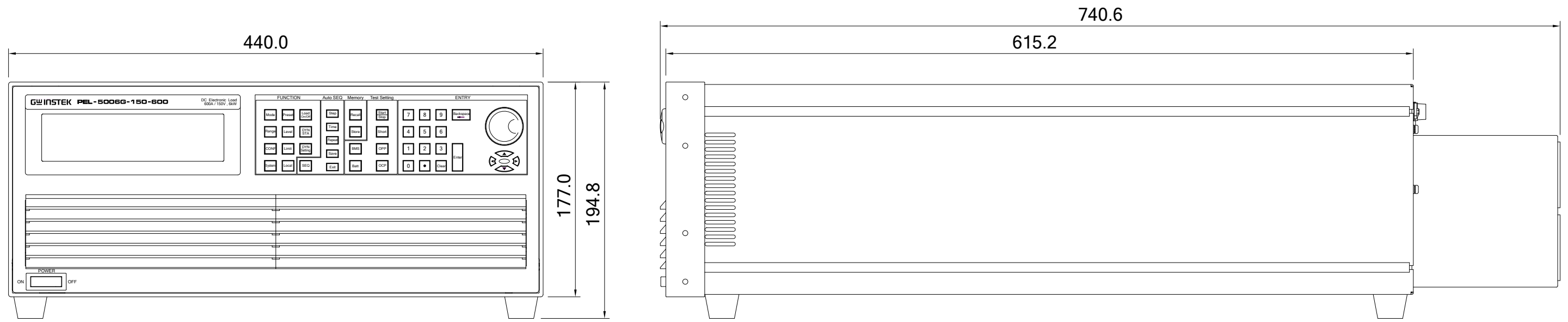

Terminal Dimensions

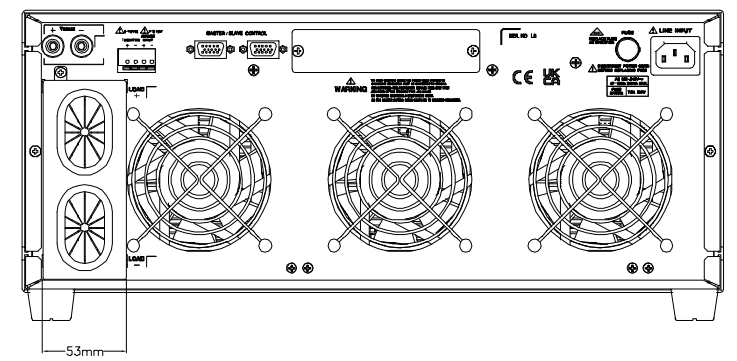
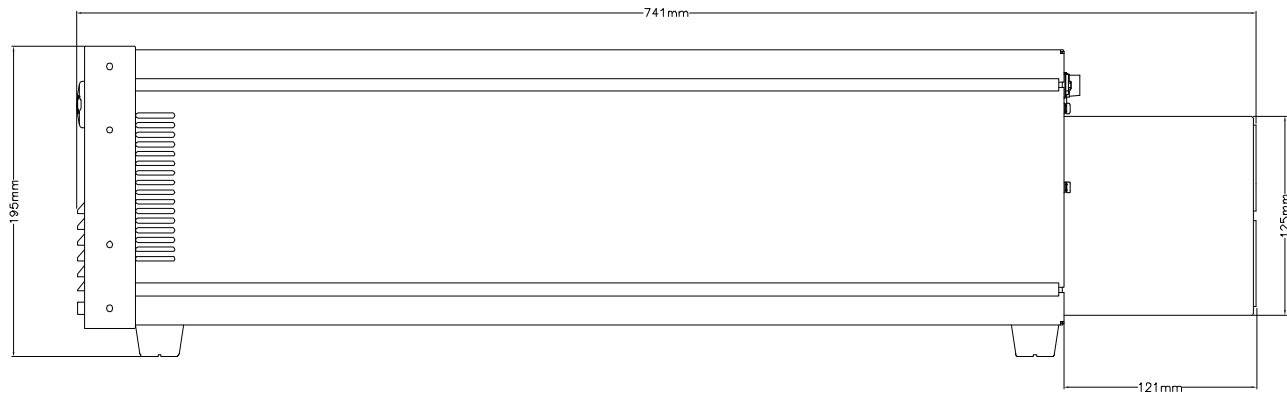
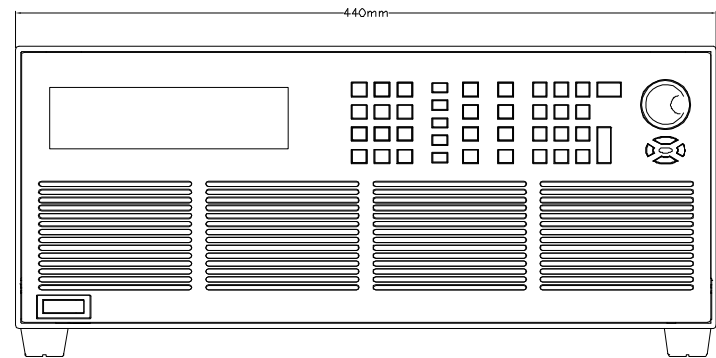
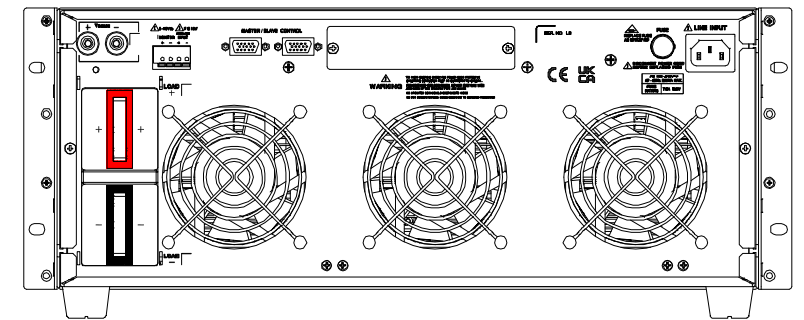
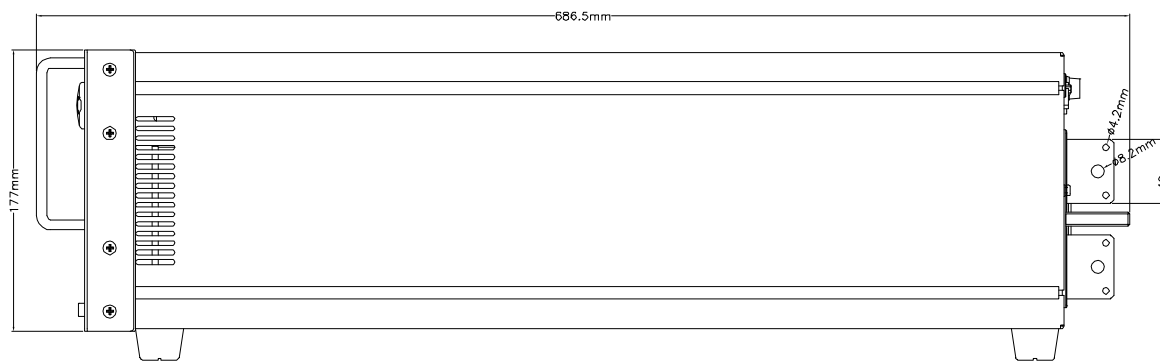
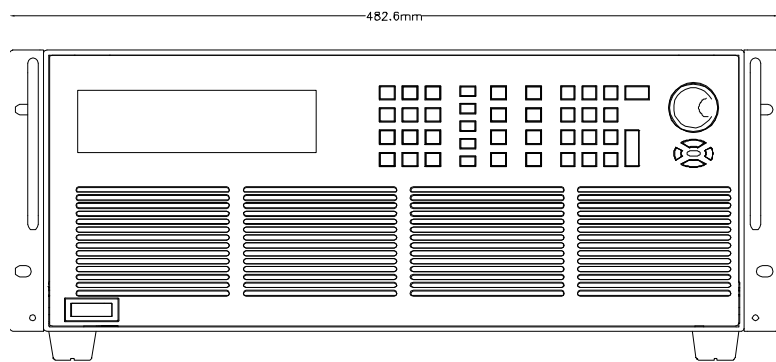

PEL-5000G series Specifications

The specifications apply when the PEL-5000G is powered on for at least 30 minutes. Note that the high frequency and high voltage options are listed as separate specifications.

PEL-5004G-150-400, PEL-5005G-150-500

Model	PEL-5004G-150-400		PEL-5005G-150-500	
Power*1	0 – 4kW	0 – 6kW max.*1	0 – 5kW	0 – 7.5kW max.*1
Current	0 – 400A	0 – 600A max.*1	0 – 500A	0 – 750A max.*1
Voltage	0 – 150V			
Min. Operating Voltage	0.7V@400A		0.7V@500A	
Protections				
Over Power Protection (OPP)	105%			
Over Current Protection (OCP)	104%			
Over Voltage Protection (OVP)	105%			
Over Temp Protection (OTP)	90°C±5°C			
Constant Current Mode				
Range*2	0 – 40A	0 – 400A	0 – 50A	0 – 500A
Resolution	0.64mA	6.4mA	0.80mA	8.0mA
Accuracy*3	± 0.05% of (Setting + Range)			
Constant Resistance Mode				
Range	0.375Ω – 22.5kΩ	0.0018Ω – 0.375Ω	0.3Ω – 18kΩ	0.0015Ω – 0.3Ω
Resolution	44μS	6.25μΩ	56μS	5μΩ
Accuracy	± 0.1%(Vin/Setting) ± 0.1% I.F.S.	± 0.1% of (Setting + Range) ± 0.1% I.F.S.	± 0.1%(Vin/Setting) ± 0.1% I.F.S.	± 0.1% of (Setting + Range) ± 0.1% I.F.S.
Constant Voltage Mode				
Range	0 – 150V			
Resolution	2.5mV			
Accuracy	± 0.05% of (Setting + Range)			
Constant Power Mode				
Range	0 – 400W	400 – 4kW	0 – 500W	500 – 5kW
Resolution	6.4mW	64mW	8mW	80mW
Accuracy*4	± 0.2% of (Setting + Range)			
Constant Voltage Mode + Current Limit Mode				
Range	150V	400A	150V	500A
Resolution	2.5mV	6.4mA	2.5mV	8mA
Accuracy*4	± 0.05% of (Setting + Range)	± 1.0% of (Setting + Range)	± 0.05% of (Setting + Range)	± 1.0% of (Setting + Range)
Constant Voltage Mode + Power Limit Mode				
Range	150V	4kW	150V	5kW

Resolution	2.5mV	64mW	2.5mV	80mW
Accuracy*4	± 0.05% of (Setting + Range)	± 1.0% of (Setting + Range)	± 0.05% of (Setting + Range)	± 1.0% of (Setting + Range)
Turbo mode*5	OFF	ON	OFF	ON
Short/OCP/OPP test function				
Max. Current	400A	600A	500A	750A
Max. Power	4000W	6000W	5000W	7500W
Test Accuracy*6	± 1.0% of (Reading + Range)			
Short Time	100 – 10000mS Continuous	100 – 2000mS	100 – 10000mS Continuous	100 – 2000mS
Setting Accuracy	±5mS			
Short V Hi	Setting range: 0.00V – 150.00V/ Resolution: 0.0025V			
Short V Lo	Setting range: 0.00V – 150.00V/ Resolution: 0.0025V			
OCP Time(Tstep)	100ms	20ms	100ms	20ms
Setting Accuracy	±5mS			
OCP ISTAR/ ISTEP/ISTOP	Setting range : 0.00A – 400.00A Resolution: 6.4mA	Setting range : 0.00A – 600.00A Resolution: 9.6mA	Setting range : 0.00A – 500.00A Resolution: 8.0mA	Setting range : 0.00A – 750.00A Resolution: 12mA
OCP VTH	Setting range: 0.00V - 150.00V/ Resolution: 0.0025 V			
OPP Time(Tstep)	100ms	20ms	100ms	20ms
Setting Accuracy	±5mS			
OPP PSTAR/ PSTEP/PSTOP	Setting range : 0.00W – 4000.0W Resolution: 64.0mW	Setting range : 0.00W – 6000.0W Resolution: 96.0mW	Setting range : 0.00W – 5000.0W Resolution: 80.0mW	Setting range : 0.00W – 7500.0W Resolution: 120mW
OPP VTH	Setting range: 0.00V - 150.00V/ Resolution:0.0025V			
Batt test Mode				
Mode CC	Setting range: 0.00A – 400.00A/ Resolution: 6.4mA		Setting range: 0.00A – 500.00A/ Resolution: 8.0mA	
Mode CP	Setting range: 0.00W – 4000.0W/ Resolution: 64.0mW		Setting range: 0.00W - 5000.0W/ Resolution: 80.0mW	
STOP Voltage(UVP)	Setting range: 0.00V – 150.00V/ Resolution: 0.0025V			
STOP TIME	Setting range: OFF, 1 – 9999s/ Resolution: 1s			
STOP CAP.AH	Setting range: OFF, 0.1 – 1999,9AH/ Resolution: 0.1AH			
STOP CAP.WH	Setting range: OFF, 0.1 – 1999,9WH/ Resolution: 0.1WH			
BMS Test Mode*7 Turbo mode				
Max. Current	400A	600A	500A	750A
Meas. Accuracy*6	±3.0% of (Reading + Range)			
Short test Time	0.05ms – 10ms. Resolution: 0.01ms			
Meas. Accuracy	±0.02mS			
Setting Accuracy	±0.05mS			
Short ITH	Setting range: 0.19A – 200.00A / Resolution: 6.4mA	Setting range: 0.28A – 300.00A/ Resolution: 9.6mA	Setting range: 0.24A – 250.00A / Resolution: 8.0mA	Setting range: 0.36A – 375.00A/ Resolution: 12mA
OCP ISTAR	Setting range: 0.64A – 400.00A / Resolution: 6.4mA	Setting range: 0.96A – 600.00A / Resolution: 9.6mA	Setting range: 0.80A – 500.00A / Resolution: 8.0mA	Setting range: 1.20A – 750.00A / Resolution: 12mA

OCP TSTEP	0.05 – 10ms, 11 – 1000ms	0.05 – 10ms,	0.05 – 10ms, 11 – 1000ms	0.05 – 10ms,
Meas. Accuracy	±0.1ms/±0.5ms	±0.5ms	±0.1ms/±0.5ms	±0.5ms
OCP ISTEP	Setting range: 0.00A – 400.00A / Resolution: 6.4mA	Setting range: 6.00A – 600.00A / Resolution: 9.6mA	Setting range: 0.00A – 500.00A / Resolution: 8.0mA	Setting range: 7.50A – 750.00A / Resolution: 12mA
OCP ISTOP	Setting range: 0.64A – 400.00A / Resolution: 6.4mA	Setting range: 0.96A – 600.00A / Resolution: 9.6mA	Setting range: 0.80A – 500.00A / Resolution: 8.0mA	Setting range: 1.20A – 750.00A / Resolution: 12mA
OCP ITH	Setting range: 0.19A – 200.00A / Resolution: 6.4mA	Setting range: 0.28A – 300.00A / Resolution: 9.6mA	Setting range: 0.24A – 250.00A / Resolution: 8.0mA	Setting range: 0.36A – 375.00A / Resolution: 12mA
Surge Test Mode				
Surge current	0 – 600A		0 – 750A	
Normal current	0 – 300A		0 – 375A	
Surge time	10 – 2000ms			
Surge step	1 – 5			
SEQ Load Mode (Remote only)				
Load mode	CC/ CP			
Setting STEP	2 – 16			
Timing	20 – 1000µs / 2 – 65535ms / 66 – 999Sec			
Resolution	10µs / 1ms / 1Sec			
Dynamic Mode				
Timing				
Thigh & Tlow	0.010 – 9.999 / 99.99 / 999.9 / 9999ms			
Resolution	0.001 / 0.01 / 0.1 / 1mS			
Accuracy	1µS / 10µS / 100µS / 1mS + 50ppm			
Slew rate	0.0256 – 1.600A/µS	0.2560 – 16.000A/µS	0.0320 – 2.000A/µS	0.3200 – 20.000A/µS
Resolution	0.0064A/µS	0.064A/µS	0.008A/µS	0.08A/µS
Min. Rise Time	25µS (typical)			
Accuracy	±(5% of Setting)±10µs			
Current				
Range	0 – 40A	40 – 400A	0 – 50A	50 – 500A
Resolution	0.64mA	6.4mA	0.8mA	8mA
Conf key parameter				
LDon voltage	Setting range: 0.25V – 62.50V / Resolution: 0.25V			
LDoFF voltage	Setting range: 0.000V – 62.250V / Resolution: 0.0025V			
Average time	0 – 64			
CV res. speed	1 – 4 (Fastest)			
Measurement				
Voltage Read Back				
Range (5 Digital)	0 – 15V	15 – 150V	0 – 15V	15 – 150V
Resolution	0.25mV	2.5mV	0.25mV	2.5mV
Accuracy	± 0.025% of (Reading + Range)			
Current Read Back				
Range (5 Digital)	0 – 40A	40 – 400A	0 – 50A	50 – 500A
Resolution	0.64mA	6.4mA	0.8mA	8mA

Accuracy $\pm 0.05\%$ of (Reading + Range)

Power Read Back

Range (5 Digital) 4kW 5kW

Resolution 0.01W 0.01W

Accuracy^{*4} $\pm 0.06\%$ of (Reading + Range)

General

Typical Short Resistance 1.8m Ω 1.5m Ω

Maximum Short Current 400A 500A

Load ON Voltage 0.25 – 62.5V

Load OFF Voltage 0 – 62.25V

Power Consumption 550VA

Dimension(H x W x D) 177mm x 440mm x 745mm

Weight 28kg

Temperature^{*8} 0 – 40°C

Safety & EMC CE

PEL-5006G-150-600, PEL-5004G-600-280

Model	PEL-5006G-150-600		PEL-5004G-600-280	
Power ^{*1}	0 – 6kW	0 – 9kW max. ^{*1}	0 – 4kW	0 – 6kW max. ^{*1}
Current	0 – 600A	0 – 900A max. ^{*1}	0 – 280A	0 – 420A max. ^{*1}
Voltage	0 – 150V		0 – 600V	
Min. Operating Voltage	0.7V@600A		10V@280A	
Protections				
Over Power Protection(OPP)	105%			
Over Current Protection(OCP)	104%			
Over Voltage Protection(OVP)	105%			
Over Temp Protection(OTP)	90°C \pm 5°C			
Constant Current Mode				
Range ^{*2}	0 – 60A	0 – 600A	0 – 28A	0 – 280A
Resolution	0.96mA	9.6mA	0.448mA	4.48mA
Accuracy ^{*3}	$\pm 0.05\%$ of (Setting + Range)			
Constant Resistance Mode				
Range	0.25 Ω – 15k Ω	0.0012 Ω – 0.25 Ω	2.1435 Ω – 128610 Ω	0.0357 Ω – 2.1435 Ω
Resolution	67 μ S	4.167 μ S	8 μ S	35.73 μ S
Accuracy	$\pm 0.1\%$ (Vin/Setting) $\pm 0.1\%$ IF.S	$\pm 0.1\%$ of (Setting + Range) $\pm 0.1\%$ IF.S	$\pm 0.1\%$ (Vin/Setting) $\pm 0.1\%$ IF.S	$\pm 0.1\%$ of (Setting + Range) $\pm 0.1\%$ IF.S
Constant Voltage Mode				
Range	0 – 150V		0 – 600V	
Resolution	2.5mV		10mV	
Accuracy	$\pm 0.05\%$ of (Setting + Range)			
Constant Power Mode				
Range	0 – 600W	600 – 6kW	0 – 400W	400 – 4kW
Resolution	9.6mW	96mW	6.4mW	64mW

Accuracy*4	± 0.2% of (Setting + Range)		± 0.2% of (Setting + Range)	
Constant Voltage Mode + Current Limit Mode				
Range	150V	600A	600V	280A
Resolution	2.5mV	9.6mA	10mV	4.48mA
Accuracy*4	± 0.05% of (Setting + Range)	± 1.0% of (Setting + Range)	± 0.05% of (Setting + Range)	± 1.0% of (Setting + Range)
Constant Voltage Mode + Power Limit Mode				
Range	150V	6kW	600V	4kW
Resolution	2.5mV	96mW	10mV	64mW
Accuracy*4	± 0.05% of (Setting + Range)	± 1.0% of (Setting + Range)	± 0.05% of (Setting + Range)	± 1.0% of (Setting + Range)
Turbo mode*5	OFF	ON	OFF	ON
Short/OCP/OPP test function				
Max. Current	600A	900A	280A	420A
Max. Power	6000W	9000W	4000W	6000W
Test Accuracy*6	± 1.0% of (Reading + Range)			
Short Time	100 – 10000ms Continuous	100 – 2000ms	100 – 10000ms Continuous	100 – 2000ms
Setting Accuracy	±5mS			
Short V Hi	Setting range: 0.00V - 150.00V / Resolution: 0.0025V		Setting range: 0.00V - 600.00V / Resolution: 0.01V	
Short V Lo	Setting range: 0.00V - 150.00V / Resolution: 0.0025V		Setting range: 0.00V - 600.00V / Resolution: 0.01V	
OCP Time(Tstep)	100ms	20ms	100ms	20ms
Setting Accuracy	±5mS			
OCP ISTAR/ ISTEP/ISTOP	Setting range: 0.00A – 600.00A Resolution: 9.60mA	Setting range: 0.00A – 900.00A Resolution: 14.4mA	Setting range: 0.00A – 280.00A Resolution: 4.48mA	Setting range: 0.00A – 420.00A Resolution: 6.72mA
OCP VTH	Setting range: 0.00V - 150.00V/ Resolution: 0.0025 V		Setting range: 0.00V - 600.00V / Resolution: 0.01 V	
OPP Time(Tstep)	100ms	20ms	100ms	20ms
Setting Accuracy	±5mS			
OPP PSTAR/ PSTEP/PSTOP	Setting range: 0.00W – 6000.0W Resolution: 96mW	Setting range: 0.00W – 9000.0W Resolution: 144mW	Setting range: 0.00W – 4000.0W Resolution: 64mW	Setting range: 0.00W – 6000.0W Resolution: 96mW
OPP VTH	Setting range: 0.00V – 150.00V/ Resolution:0.0025V		Setting range: 0.00V – 600.00V/ Resolution:0.01V	
Batt test Mode				
Mode CC	Setting range: 0.00A – 600.00A/ Resolution: 9.6mA		Setting range: 0.00A – 280.00A/ Resolution: 4.48mA	
Mode CP	Setting range: 0.00W – 6000.0W/ Resolution: 96mW		Setting range: 0.00W – 4000.0W/ Resolution: 64mW	
STOP Voltage(UVP)	Setting range: 0.00V – 150.00V/ Resolution: 0.0025V		Setting range: 0.00V – 600.00V/ Resolution: 0.01V	
STOP TIME	Setting range: OFF, 1 – 99999s/ Resolution: 1s			
STOP CAP.AH	Setting range: OFF, 0.1 – 1999,9AH/ Resolution: 0.1AH			
STOP CAP.WH	Setting range: OFF, 0.1 – 1999,9WH/ Resolution: 0.1WH			

BMS Test Mode ^{*7} Turbo mode				
Max. Current	600A	900A	280A	420A
Meas. Accuracy ^{*6}	±3.0% of (Reading + Range)			
Short Time	0.05ms~10ms. Resolution: 0.01ms			
Meas. Accuracy	±0.02mS			
Setting Accuracy	±0.05mS			
Short ITH	Setting range:	Setting range:	Setting range:	Setting range:
	0.28A – 300.00A Resolution: 9.6mA	0.43A – 450.00A Resolution: 14.4mA	0.13A – 140.00A / Resolution: 4.48mA	0.20A – 210.00A/ Resolution: 6.72mA
OCP ISTAR	Setting range:	Setting range:	Setting range:	Setting range:
	0.96A – 600.00A / Resolution: 9.6mA	1.44A – 900.00A / Resolution: 14.4mA	0.44A – 280.00A / Resolution: 4.48mA	0.67A – 420.00A / Resolution: 6.72mA
OCP TSTEP	0.05 – 10ms, 11 – 1000ms	0.05 – 10ms,	0.05 – 10ms, 11 – 1000ms	0.05 – 10ms,
Meas. Accuracy	±0.1ms/±0.5ms	±0.5ms	±0.1ms/±0.5ms	±0.5ms
OCP ISTEP	Setting range:	Setting range:	Setting range:	Setting range:
	0.00A – 600.00A / Resolution: 9.6mA	9.00A – 900.00A / Resolution: 14.4mA	0.00A – 280.00A / Resolution: 4.48mA	4.20A – 420.00A / Resolution: 6.72mA
OCP ISTOP	Setting range:	Setting range:	Setting range:	Setting range:
	0.96A – 600.00A / Resolution: 9.6mA	1.44A – 900.00A / Resolution: 14.4mA	0.44A – 280.00A / Resolution: 4.48mA	0.67A – 420.00A / Resolution: 6.72mA
OCP ITH	Setting range:	Setting range:	Setting range:	Setting range:
	0.28A – 300.00A / Resolution: 9.6mA	0.43A – 450.00A / Resolution: 14.4mA	0.13A – 140.00A / Resolution: 4.48mA	0.20A – 210.00A / Resolution: 6.72mA
Surge Test Mode				
Surge current	0 – 900A		0 – 420A	
Normal current	0 – 450A		0 – 210A	
Surge time	10 – 2000ms			
Surge step	1 – 5			
SEQ Load Mode (remote only)				
Load mode	CC/ CP			
Setting STEP	2 – 16			
Timing	20 – 1000us/ 2 – 65535ms/ 66 – 999Sec			
Resolution	10us/ 1ms/ 1Sec			
Dynamic Mode				
Timing				
Thigh & Tlow	0.010 – 9.999/ 99.99/ 999.9/ 9999mS			
Resolution	0.001/ 0.01/ 0.1/ 1mS			
Accuracy	1μS/ 10μS/ 100μS/ 1mS + 50ppm			
Slew rate	0.0384 – 2.400A/μS 0.3840 – 24.000A/μS 0.01792 – 1.120A/μS 0.1792 – 11.200A/μS			
Resolution	0.0096A/μS	0.096A/μS	0.00448A/μS	0.0448A/μS
Min. Rise Time	25μS(typical)			
Accuracy	±(5% of Setting)±10μs			
Current				
Range	0 – 60A	60 – 600A	0 – 28A	28 – 280A
Resolution	0.96mA	9.6mA	0.45mA	4.48mA

Conf key parameter				
LDon voltage	Setting range: 0.25V – 62.50V/ Resolution: 0.25V		Setting range: 0.4V – 100.0V/ Resolution: 0.4V	
LDoFF voltage	Setting range: 0.000V – 62.250V/ Resolution: 0.0025V		Setting range: 0.000V – 99.60V / Resolution: 0.01V	
Average time	0 – 64			
CV res. speed	1 – 4 (Fastest)			
Measurement				
Voltage Read Back				
Range (5 Digital)	0 – 15V	15 – 150V	0 – 60V	60 – 600V
Resolution	0.25mV	2.5mV	1.00mV	10.0mV
Accuracy	± 0.025% of (Reading + Range)			
Current Read Back				
Range (5 Digital)	0 – 60A	60 – 600A	0 – 28A	28 – 280A
Resolution	0.96mA	9.6mA	0.448mA	4.48mA
Accuracy	± 0.05% of (Reading + Range)			
Power Read Back				
Range (5 Digital)	6kW		4kW	
Resolution	0.01W			
Accuracy ^{*4}	± 0.06% of (Reading + Range)			
General				
Typical Short Resistance	1.2mΩ		35.73mΩ	
Maximum Short Current	600A		280A	
Load ON Voltage	0.25 – 62.5V		0.4 – 100V	
Load OFF Voltage	0 – 62.25V		0 – 99.6V	
Power Consumption	550VA			
Dimension(H x W x D)	177mm x 440mm x 745mm			
Weight	28kg		29kg	
Temperature ^{*8}	0 – 40°C			
Safety & EMC	CE			

PEL-5005G-600-350, PEL-5006G-600-420

Model	PEL-5006G-600-350		PEL-5004G-600-420	
Power ^{*1}	0 – 5kW	0 – 7.5kW max. ^{*1}	0 – 6kW	0 – 9kW max. ^{*1}
Current	0 – 350A	0 – 525A max. ^{*1}	0 – 420A	0 – 630A max. ^{*1}
Voltage	0 – 600V			
Min. Operating Voltage	10V@350A		10V@420A	
Protections				
Over Power Protection(OPP)	105%			
Over Current Protection(OCP)	104%			
Over Voltage Protection(OVP)	105%			
Over Temp Protection(OTP)	90°C±5°C			

Constant Current Mode				
Range ^{*2}	0 – 35A	0 – 350A	0 – 42A	0 – 420A
Resolution	0.56mA	5.6mA	0.672mA	6.72mA
Accuracy ^{*3}	± 0.05% of (Setting + Range)			
Constant Resistance Mode				
Range	1.7148Ω – 102888Ω	0.0285Ω – 1.7148Ω	1.4290Ω – 85740Ω	0.0238Ω – 1.4290Ω
Resolution	10μS	28.584μΩ	12μS	23.82μΩ
Accuracy	± 0.1% (Vin/Setting) ± 0.1% IF.S	± 0.1% of (Setting + Range) ± 0.1% IF.S	± 0.1% (Vin/Setting) ± 0.1% IF.S	± 0.1% of (Setting + Range) ± 0.1% IF.S
Constant Voltage Mode				
Range	0 – 600V			
Resolution	0mV			
Accuracy	± 0.05% of (Setting + Range)			
Constant Power Mode				
Range	0 – 500W	500 – 5kW	0 – 600W	600 – 6kW
Resolution	8mW	80mW	9.6mW	96mW
Accuracy ^{*4}	± 0.2% of (Setting + Range)			
Constant Voltage + Current Limit Mode				
Range	600V	350A	600V	420A
Resolution	10mV	5.6mA	10mV	6.72mA
Accuracy ^{*4}	± 0.05% of (Setting + Range)	± 1.0% of (Setting + Range)	± 0.05% of (Setting + Range)	± 1.0% of (Setting + Range)
Constant Voltage Mode + Power Limit Mode				
Range	600V	5kW	600V	6kW
Resolution	10mV	80mW	10mV	96mW
Accuracy ^{*4}	± 0.05% of (Setting + Range)	± 1.0% of (Setting + Range)	± 0.05% of (Setting + Range)	± 1.0% of (Setting + Range)
Turbo mode ^{*5}	OFF	ON	OFF	ON
Short/OCP/OPP test function				
Max. Current	350A	525A	420A	630A
Max. Power	5000W	7500W	6000W	9000W
Test Accuracy ^{*6}	± 1.0% of (Reading + Range)			
Short Time	100 – 10000ms Continuous	100 – 2000ms	100 – 10000ms Continuous	100 – 2000ms
Setting Accuracy	±5mS			
Short V Hi	Setting range: 0.00V – 600.00V/ Resolution: 0.01V			
Short V Lo	Setting range: 0.00V – 600.00V/ Resolution: 0.01V			
OCP Time(Tstep)	100ms	20ms	100ms	20ms
Setting Accuracy	±5mS			
OCP ISTAR/ ISTEP/ISTOP	Setting range: 0.00A – 350.00A Resolution: 5.6mA	Setting range: 0.00A – 525.00A Resolution: 8.4mA	Setting range: 0.00A – 420.00A Resolution: 6.72mA	Setting range: 0.00A – 630.00A Resolution: 10.08mA
OCP VTH	Setting range: 0.00V – 600.00V/ Resolution: 0.01 V			
OPP Time(Tstep)	100ms	20ms	100ms	20ms
Setting Accuracy	±5mS			

OPP PSTAR/ PSTEP/PSTO	Setting range: 0.00W – 5000.0W Resolution: 80mW	Setting range: 0.00W – 7500.0W Resolution: 120mW	Setting range: 0.00W – 6000.0W Resolution: 96mW	Setting range: 0.00W – 9000.0W Resolution: 144mW
OPP VTH	Setting range: 0.00V - 6000V/ Resolution:0.01V			
Batt test Mode				
Mode CC	Setting range: 0.00A – 350.00A/ Resolution: 5.6mA		Setting range: 0.00A – 420.00A/ Resolution: 6.72mA	
Mode CP	Setting range: 0.00W – 5000.0W/ Resolution: 80mW		Setting range: 0.00W – 6000.0W/ Resolution: 96mW	
STOP Voltage(UVP)	Setting range: 0.00V – 600.00V/ Resolution: 0.01V			
STOP TIME	Setting range: OFF, 1 – 99999s/ Resolution: 1s			
STOP CAP.AH	Setting range: OFF, 0.1 – 1999, 9AH / Resolution: 0.1AH			
STOP CAP.WH	Setting range: OFF, 0.1 – 1999, 9WH / Resolution: 0.1WH			
BMS Test Mode*7 Turbo mode				
Max. Current	350A	525A	420A	630A
Meas. Accuracy*6	±3.0% of (Reading + Range)			
Short test Time	0.05ms – 10ms. Resolution: 0.01ms			
Meas. Accuracy	±0.02mS			
Setting Accuracy	±0.05mS			
Short ITH	Setting range: 0.16A – 175.0A / Resolution: 5.6mA	Setting range: 0.25A –262.5A/ Resolution: 8.4mA	Setting range: 0.20A –210.0A / Resolution: 6.72mA	Setting range: 0.30A – 315.0A/ Resolution: 10.08mA
OCP ISTAR	Setting range: 0.56A – 350.00A / Resolution: 5.6mA	Setting range: 0.84A – 525.00A / Resolution: 8.4mA	Setting range: 0.67A – 420.00A / Resolution: 6.72mA	Setting range: 1.00A – 630.00A / Resolution: 10.08A
OCP TSTEP	0.05 – 10ms, 11 – 1000ms	0.05 – 10ms,	0.05 – 10ms, 11 – 1000ms	0.05 – 10ms,
Meas. Accuracy	±0.1ms/±0.5ms	±0.5ms	±0.1ms/±0.5ms	±0.5ms
OCP ISTEP	Setting range: 0.00A – 350.0A / Resolution: 5.6mA	Setting range: 5.25A – 525.0A/ Resolution: 8.4mA	Setting range: 0.00A – 420.0A / Resolution: 6.72mA	Setting range: 6.30A – 630.0A/ Resolution: 10.08mA
OCP ISTOP	Setting range: 0.56A – 350.00A / Resolution: 5.6mA	Setting range: 0.84A – 525.00A / Resolution: 8.4mA	Setting range: 0.67A – 420.00A / Resolution: 6.72mA	Setting range: 1.00A – 630.00A / Resolution: 10.08mA
OCP ITH	Setting range: 0.16A – 175.0A / Resolution: 5.6mA	Setting range: 0.25A –262.5A/ Resolution: 8.4mA	Setting range: 0.20A –210.0A / Resolution: 6.72mA	Setting range: 0.30A – 315.0A/ Resolution: 10.08mA
Surge Test Mode				
Surge current	0 – 525A		0 – 630A	
Normal current	0 – 262.5A		0 – 315A	
Surge time	10 – 2000ms			
Surge step	1 – 5			
SEQ Load Mode (remote only)				
Load mode	CC/ CP			
Setting STEP	2 – 16			

Timing	20 – 1000us / 2 – 65535ms / 66 – 999Sec			
Resolution	10μs / 1ms / 1Sec			
Dynamic Mode				
Timing				
Thigh & Tlow	0.010 – 9.999 / 99.99 / 999.9 / 9999mS			
Resolution	0.001 / 0.01 / 0.1 / 1mS			
Accuracy	1μS / 10μS / 100μS / 1mS + 50ppm			
Slew rate	0.0224 – 1.400A/μS 0.2240 – 14.00A/μS 0.02688 – 1.680A/μS 0.2688 – 16.800A/μS			
Resolution	0.0056A/μS 0.056A/μS 0.00672A/μS 0.0672A/μS			
Min. Rise Time	25μS (typical)			
Accuracy	± (5% of Setting) ± 10μs			
Current				
Range	0 – 5A	35 – 350A	0 – 42A	42 – 420A
Resolution	0.56mA	5.6mA	0.67mA	6.72mA
Conf key parameter				
LDon voltage	Setting range: 0.4V – 100.0V / Resolution: 0.4V			
LDoFF voltage	Setting range: 0.000V – 99.60V / Resolution: 0.01V			
Average time	0 – 64			
CV res. speed	1 – 4 (Fastest)			
Measurement				
Voltage Read Back				
Range (5 Digital)	0 – 60V	60 – 600V	0 – 60V	60 – 600V
Resolution	1.00mV	10.0mV	1.00mV	10.0mV
Accuracy	± 0.025% of (Reading + Range)			
Current Read Back				
Range (5 Digital)	0 – 35A	35 – 350A	0 – 42A	42 – 420A
Resolution	0.56mA	5.6mA	0.672mA	6.72mA
Accuracy	± 0.05% of (Reading + Range)			
Power Read Back				
Range (5 Digital)	5kW		6kW	
Resolution	0.01W			
Accuracy ^{*4}	± 0.06% of (Reading + Range)			
General				
Typical Short Resistance	28.584mΩ		23.82mΩ	
Maximum Short Current	350A		420A	
Load ON Voltage	0.4 – 100V			
Load OFF Voltage	0 – 99.60V			
Power Consumption	550VA			
Dimension (H x W x D)	177mm x 440mm x 745mm			
Weight	29kg			
Temperature ^{*8}	0 – 40°C			
Safety & EMC	CE			

PEL-5004G-1200-160

Model	PEL-5004G-1200-160	
Power ^{*1}	0 – 4kW	0 – 6kW max. ^{*1}
Current	0 – 160A	0 – 240A max. ^{*1}
Voltage	0 – 1200V	
Min. Operating Voltage	15V@100A	
Protections		
Over Power Protection(OPP)	105%	
Over Current Protection(OCP)	104%	
Over Voltage Protection(OVP)	105%	
Over Temp Protection(OTP)	90°C±5°C	
Constant Current Mode		
Range ^{*2}	0 – 16A	0 – 160A
Resolution	0.256mA	2.56mA
Accuracy ^{*3}	± 0.05% of (Setting + Range)	
Constant Resistance Mode		
Range	7.5Ω – 450kΩ	0.0937Ω – 7.5Ω
Resolution	2.2μS	125μΩ
Accuracy	± 0.1% (Vin/Setting) ±0.1% IF.S	± 0.1% of (Setting + Range) ±0.1% IF.S
Constant Voltage Mode		
Range	0 – 1200V	
Resolution	20mV	
Accuracy	± 0.05% of (Setting + Range)	
Constant Power Mode		
Range	0–400W	400 – 4kW
Resolution	6.4mW	64mW
Accuracy ^{*4}	± 0.2% of (Setting + Range)	
Constant Voltage Mode + Current Limit Mode		
Range	1200V	160A
Resolution	20mV	2.56mA
Accuracy ^{*4}	± 0.05% of (Setting + Range)	± 1.0% of (Setting + Range)
Constant Voltage Mode + Power Limit Mode		
Range	1200V	4kW
Resolution	20mV	64mW
Accuracy ^{*4}	± 0.05% of (Setting + Range)	± 1.0% of (Setting + Range)
Turbo mode ^{*5}	OFF	ON
Short/OCP/OPP test function		
Max. Current	160A	240A
Max. Power	4000W	6000W
Test Accuracy ^{*6}	± 1.0% of (Reading + Range)	
Short Time	100 – 10000ms	100 – 2000ms
	Continuous	
Setting. Accuracy	±5mS	

Short V Hi	Setting range: 0.25V – 1200.00V/ Resolution: 0.02V	
Short V Lo	Setting range: 0.00V – 1200.00V/ Resolution: 0.02V	
OCP Time(Tstep)	100ms	20ms
Setting Accuracy	±5mS	
OCP ISTAR/ ISTEP/ISTOP	Setting range: 0.00A – 160.00A Resolution: 2.56mA	Setting range: 0.00A - 240.00A Resolution: 3.84mA
OCP VTH	Setting range: 0.00V – 1200.00V / Resolution: 0.02V	
OPP Time(Tstep)	100ms	20ms
Setting Accuracy	±5mS	
OPP PSTAR/ PSTEP/PSTOP	Setting range: 0.00W – 4000.0W Resolution: 64mW	Setting range: 0.00W – 6000.0W Resolution: 96mW
OPP VTH	Setting range: 0.00V – 1200.00V / Resolution: 0.02V	
Batt test		
Mode CC	Setting range: 0.00A – 160.00A Resolution: 2.56mA	
Mode CP	Setting range: 0.00W – 4000.0W Resolution: 64mW	
STOP Voltage(UVP)	Setting range: 0.00V – 1200.00V/ Resolution: 0.02V	
STOP TIME	Setting range: OFF, 1 – 99999s/ Resolution: 1s	
STOP CAP.AH	Setting range: OFF, 0.1 – 1999,9AH/ Resolution: 0.1AH	
STOP CAP.WH	Setting range: OFF, 0.1 – 1999,9WH/ Resolution: 0.1WH	
BMS Test Mode^{*7} Turbo mode		
Max. Current	160A	240A
Meas. Accuracy ^{*6}	±3.0% of (Reading + Range)	
Short test Time	0.05 – 10ms. Resolution: 0.01ms	
Meas. Accuracy	±0.02mS	
Setting Accuracy	±0.05mS	
Short ITH	Setting range: 0.07A – 80.00A Resolution: 2.56mA	Setting range: 0.11A – 120.00A Resolution: 3.84mA
OCP ISTAR	Setting range: 0.25A – 160.00A Resolution: 2.56mA	Setting range: 0.38A – 240.00A Resolution: 3.84A
OCP TSTEP)	0.05 – 10ms 11 – 1000ms	0.05 – 10ms
Meas. Accuracy	±0.1ms/±0.5ms	
OCP ISTEP	Setting range: 0.00A – 160.00A Resolution: 2.56mA	Setting range: 2.40A – 240.00A Resolution: 3.84mA
OCP ISTOP	Setting range: 0.25A – 160.00A Resolution: 2.56mA	Setting range: 0.38A – 240.00A Resolution: 3.84mA
OCP ITH	Setting range: 0.07A – 80.00A Resolution: 2.56mA	Setting range: 0.11A – 120.00A Resolution: 3.84mA
Surge Test Mode		
Surge current	0 – 240A	
Normal current	0 – 120A	
Surge time	10 – 2000ms	
Surge step	1 – 5	
SEQ Load Mode (remote only)		
Load mode	CC/ CP	
Setting STEP	2 – 16	
Timing	20 – 1000us/ 2 – 65535ms/ 66 – 999Sec	

Resolution	10 μ s / 1ms / 1Sec	
Dynamic Mode		
Timing		
Thigh & Tlow	0.010 – 9.999 / 99.99 / 999.9 / 9999mS	
Resolution	0.001 / 0.01 / 0.1 / 1mS	
Accuracy	1 μ S / 10 μ S / 100 μ S / 1mS + 50ppm	
Slew rate	0.01024 – 0.640A/ μ S	0.1024 – 6.400A/ μ S
Resolution	0.00256A/ μ S	0.0256A/ μ S
Min. Rise Time	25 μ S(typical)	
Accuracy	\pm (5% of Setting) \pm 10 μ S	
Current		
Range	0 – 16A	16 – 160A
Resolution	0.26mA	2.56mA
Conf key parameter		
LDon voltage	Setting range: 1.0V – 250.0V / Resolution: 1.0V	
LDoFF voltage	Setting range: 0.000V – 249.0V / Resolution: 0.02V	
Average time	0 – 64	
CV res. speed	1 – 4 (Fastest)	
Measurement		
Voltage Read Back		
Range (5 Digital)	0 – 120V	120 – 1200V
Resolution	2.00mV	20.0mV
Accuracy	\pm 0.025% of (Reading + Range)	
Current Read Back		
Range (5 Digital)	0 – 16A	16 – 160A
Resolution	0.256mA	2.56mA
Accuracy	\pm 0.05% of (Reading + Range)	
Power Read Back		
Range (5 Digital)	4kW	
Resolution	0.01W	
Accuracy ^{*4}	\pm 0.06% of (Reading + Range)	
General		
Typical Short Resistance	93.75m Ω	
Maximum Short Current	160A	
Load ON Voltage	1 – 250V	
Load OFF Voltage	0 – 250V	
Power Consumption	550VA	
Dimension(H x W x D)	177mm x 440mm x 745mm	
Weight	29kg	
Temperature ^{*8}	0 – 40°C	
Safety & EMC	CE	

PEL-5005G-1200-200, PEL-5006G-1200-240

Model	PEL-5005G-1200-200		PEL-5006G-1200-240	
Power ^{*1}	0 – 5kW	0 – 7.5kW max. ^{*1}	0 – 6kW	0 – 9kW max. ^{*1}
Current	0 – 200A	0 – 300A max. ^{*1}	0 – 240A	0 – 360A max. ^{*1}
Voltage	0 – 1200V			
Min. Operating Voltage	15V@200A		15V@240A	
Protections				
Over Power Protection(OPP)	105%			
Over Current Protection(OCP)	104%			
Over Voltage Protection(OVP)	105%			
Over Temp Protection(OTP)	90°C±5°C			
Constant Current Mode				
Range ^{*2}	0 – 20A	0 – 200A	0 – 24A	0 – 240A
Resolution	0.32mA	3.2mA	0.384mA	3.84mA
Accuracy ^{*3}	± 0.05% of (Setting + Range)			
Constant Resistance Mode				
Range	6Ω – 360kΩ	0.075Ω – 6Ω	5Ω – 300kΩ	0.0625Ω – 5Ω
Resolution	2.8μS	100μΩ	3.3μS	83.34μΩ
Accuracy	± 0.1% (Vin/Setting) ±0.1% I.F.S	± 0.1% of (Setting + Range) ±0.1% I.F.S	± 0.1% (Vin/Setting) ±0.1% I.F.S	± 0.1% of (Setting + Range) ±0.1% I.F.S
Constant Voltage Mode				
Range	0 – 1200V			
Resolution	20mV			
Accuracy	± 0.05% of (Setting + Range)			
Constant Power Mode				
Range	0 – 500W	500 – 5kW	0 – 600W	600 – 6kW
Resolution	8mW	80mW	9.6mW	96mW
Accuracy ^{*4}	± 0.2% of (Setting + Range)			
CConstant Voltage Mode + Current Limit Mode				
Range	1200V	200A	1200V	240A
Resolution	20mV	3.2mA	20mV	3.84mA
Accuracy ^{*4}	± 0.05% of (Setting + Range)	± 1.0% of (Setting + Range)	± 0.05% of (Setting + Range)	± 1.0% of (Setting + Range)
Constant Voltage Mode + Power Limit Mode				
Range	1200V	5kW	1200V	6kW
Resolution	20mV	80mW	20mV	96mW
Accuracy ^{*4}	± 0.05% of (Setting + Range)	± 1.0% of (Setting + Range)	± 0.05% of (Setting + Range)	± 1.0% of (Setting + Range)
Turbo mode ^{*5}	OFF	ON	OFF	ON
Short/OCP/OPP test function				
Max. Current	200A	300A	240A	360A
Max. Power	5000W	7500W	6000W	9000W
Test Accuracy ^{*6}	± 1.0% of (Reading + Range)			

Short Time	100 – 10000ms Continuous	100 – 2000ms	100 – 10000ms Continuous	100 – 2000ms
Setting, Accuracy	±5mS			
Short V Hi	Setting range: 0.25V – 1200.0V/ Resolution: 0.02V			
Short V Lo	Setting range: 0.000V – 1200.0V/ Resolution: 0.02V			
OCP Time(Tstep)	100ms	20ms	100ms	20ms
Setting, Accuracy	±5mS			
OCP ISTAR/ ISTEP/ISTOP	Setting range: 0.00A – 200.00A Resolution: 3.2mA	Setting range: 0.00A – 300.00A Resolution: 4.8mA	Setting range: 0.00A – 240.00A Resolution: 3.84mA	Setting range: 0.00A – 360.00A Resolution: 5.76mA
OCP VTH	Setting range: 0.000V – 1200.0V/ Resolution: 0.02V			
OPP Time(Tstep)	100ms	20ms	100ms	20ms
Setting, Accuracy	±5mS			
OPP PSTAR/ PSTEP/PSTOP	Setting range: 0.00W – 5000.0W Resolution: 80mW	Setting range: 0.00W – 7500.0W Resolution: 120mW	Setting range: 0.00W – 6000.0W Resolution: 96mW	Setting range: 0.00W – 9000.0W Resolution: 144mW
OPP VTH	Setting range: 0.000V – 1200.0V/ Resolution: 0.02V			
Batt test Mode				
Mode CC	Setting range: 0.00A – 200.00A/ Resolution: 3.2mA		Setting range: 0.00A – 240.00A/ Resolution: 3.84mA	
Mode CP	Setting range: 0.00W - 5000.0W/ Resolution: 80mW		Setting range: 0.00W - 6000.0W/ Resolution: 96mW	
STOP Voltage(UVP)	Setting range: 0.000V – 1200.0V/ Resolution: 0.02V			
STOP TIME	Setting range: OFF, 1 – 99999s/ Resolution: 1s			
STOP CAP.AH	Setting range: OFF, 0.1 – 1999,9AH/ Resolution: 0.1AH			
STOP CAP.WH	Setting range: OFF, 0.1 – 1999,9WH/ Resolution: 0.1WH			
BMS Test Mode*7 Turbo mode				
Max. Current	200A	300A	240A	360A
Meas. Accuracy*6	±3.0% of (Reading + Range)			
Short test Time	0.05ms – 10ms. Resolution: 0.01ms			
Meas. Accuracy	±0.02mS			
Setting Accuracy	±0.05mS			
Short ITH	Setting range: 0.09A – 100.00A Resolution: 3.2mA	Setting range: 0.14A – 150.00A Resolution: 4.8mA	Setting range: 0.11A – 120.00A Resolution: 3.84mA	Setting range: 0.17A – 180.00A Resolution: 5.76mA
OCP ISTAR	Setting range: 0.32A – 200.00A Resolution: 3.2mA	Setting range: 0.48A – 300.00A Resolution: 4.8mA	Setting range: 0.38A – 240.00A Resolution: 3.84mA	Setting range: 0.57A – 360.00A Resolution: 5.76mA
OCP TSTEP	0.05 – 10ms, 11 – 1000ms	0.05 – 10ms,	0.05 – 10ms, 11 – 1000ms	0.05v10ms,
Meas. Accuracy	±0.1ms/±0.5ms	±0.5ms	±0.1ms/±0.5ms	±0.5ms
OCP ISTEP	Setting range: 0.00A – 200.00A Resolution: 3.2mA	Setting range: 3.00A – 300.00A Resolution: 4.8mA	Setting range: 0.00A – 240.00A Resolution: 3.84mA	Setting range: 3.60A – 360.00A Resolution: 5.76A
OCP ISTOP	Setting range: 0.32A – 200.00A Resolution: 3.2mA	Setting range: 0.48A – 300.00A Resolution: 4.8mA	Setting range: 0.38A – 240.00A Resolution: 3.84mA	Setting range: 0.57A – 360.00A Resolution: 5.76mA

OCPC ITH	Setting range: 0.09A – 100.00A Resolution: 3.2mA	Setting range: 0.14A – 150.00A Resolution: 4.8mA	Setting range: 0.11A – 120.00A Resolution: 3.84mA	Setting range: 0.17A – 180.00A Resolution: 5.76mA
----------	--	--	---	---

Surge Test Mode

Surge current	0 – 300A	0 – 360A
Normal current	0 – 150A	0 – 180A
Surge time	10 – 2000ms	
Surge step	1 – 5	

SEQ Load Mode (remote only)

Load mode	CC/ CP
Setting STEP	2 – 16
Timing	20 – 1000 μ s / 2 – 65535ms / 66 – 999Sec
Resolution	10 μ s / 1ms / 1Sec

Dynamic Mode**Timing**

Thigh & Tlow	0.010 – 9.999 / 99.99 / 999.9 / 9999mS			
Resolution	0.001 / 0.01 / 0.1 / 1mS			
Accuracy	1 μ S / 10 μ S / 100 μ S / 1mS + 50ppm			
Slew rate	0.0128 – 0.800A/ μ S	0.1280 – 8.000A/ μ S	0.01536 – 0.960A/ μ S	0.1536 – 9.600A/ μ S
Resolution	0.0032A/ μ S	0.032A/ μ S	0.00384A/ μ S	0.0384A/ μ S
Min. Rise Time	25 μ S (typical)			
Accuracy	\pm (5% of Setting) \pm 10 μ S			

Current

Range	0 – 20A	20 – 200A	0 – 24A	42 – 240A
Resolution	0.32mA	3.2mA	0.38mA	3.84mA

Conf key parameter

LDon voltage	Setting range: 1V – 250.0V / Resolution: 1V
LDoFF voltage	Setting range: 0.000V – 249.0V / Resolution: 0.02V
Average time	0 – 64
CV res. speed	1 – 4 (Fastest)

Measurement**Voltage Read Back**

Range (5 Digital)	0 – 120V	120 – 1200V	0 – 120V	120 – 1200V
Resolution	2.00mV	20.0mV	2.00mV	20.0mV
Accuracy	\pm 0.025% of (Reading + Range)			

Current Read Back

Range (5 Digital)	0 – 20A	20 – 200A	0 – 24A	24 – 240A
Resolution	0.32mA	3.2mA	0.384mA	3.84mA
Accuracy	\pm 0.05% of (Reading + Range)			

Power Read Back

Range (5 Digital)	5kW	6kW
Resolution	0.01W	
Accuracy ^{*4}	\pm 0.06% of (Reading + Range)	

General

Typical Short Resistance	75m Ω	62.505m Ω
Maximum Short Current	200A	240A

Load ON Voltage	1 – 250V
Load OFF Voltage	0 – 250V
Power Consumption	550VA
Dimension(H x W x D)	177mm x 440mm x 745mm
Weight	29kg
Temperature*8	0 – 40°C
Safety & EMC	CE

*1 The power rating specifications at ambient temperature = 25 °C

*2 The range is automatically or forcing to range II only in CC mode

*3 If the operating current is below range 0.1%, the accuracy specification is 0.1% F.S.

*4 Power range = Vrange x Irange

*5 Turbo mode for up to 1.5X Current rating & Power rating support BMS, Short/OCP/OPP test function

*6 The best accuracy of OCP/OPP test is Istep/Pstep=1%FS

*7 BMS Test function for Battery Management System Board SHORT, OCCP and OCPD Test

*8 Operating temperature range is 0~40°C, All specifications apply for 25°C±5°C, Except as noted

Certificate Of Compliance

We

GOOD WILL INSTRUMENT CO., LTD.

declare that the CE marking mentioned product

satisfies all the technical relations application to the product within the scope of council:

Directive: EMC; LVD; WEEE; RoHS

The product is in conformity with the following standards or other normative documents:

Ⓢ EMC	
EN 61326-1	Electrical equipment for measurement, control and laboratory use — EMC requirements
Conducted & Radiated Emission EN 55011 / EN 55032	Electrical Fast Transients EN 61000-4-4
Current Harmonics EN 61000-3-2 / EN 61000-3-12	Surge Immunity EN 61000-4-5
Voltage Fluctuations EN 61000-3-3 / EN 61000-3-11	Conducted Susceptibility EN 61000-4-6
Electrostatic Discharge EN 61000-4-2	Power Frequency Magnetic Field EN 61000-4-8
Radiated Immunity EN 61000-4-3	Voltage Dip/ Interruption EN 61000-4-11 / EN 61000-4-34
Ⓢ Safety	
EN 61010-1 :	Safety requirements for electrical equipment for measurement, control, and laboratory use - Part 1: General requirements

GPIB programming Example

C Example Program

```
/* Link this program with appropriate *cib*.obj. */
/* This application program is written in TURBO C 2.0 for the IBM
PC-AT compatible. The National Instruments Cooperation (NIC)
Model PC-2A board provides the interface between the PC-AT and
a PRODIGIT MPAL ELECTRONIC LOAD. The appropriate *cib*.obj
file is required in each program to properly link the NIC board to C
LANGUAGE. and include the <decl.h.> HEADER FILE to C
LANGUAGE. */

#include <stdio.h>
#include <dos.h>
#include <math.h>
#include "decl.h"      /* NI GPIB CARD HEADER FILE */

main()
{
    char ouster[20],rdbuf[15],spec[10];
    int i,ch,load;
    /* Assign unique identifier to the device "dev5" and store in
variable load. check for error. ibfind error = negative value returned.
*/
    if((load = ibfind("dev5")) < 0) /* Device variable name is load */
    {
        /* GPIB address is 5 */
        printf("\r*** INTERFACE ERROR ! ***\a\n");
        printf("\r\nError routine to notify that ibfind failed.\n");
        printf("\r\nCheck software configuration.\n");
        exit(1);
    }
}
```

```
/* Clear the device */
if((ibclr(load)) & ERR);
{
    printf("INTERFACE ERROR ! \a");
    exit (1);
}
clrscr();
/* Clear load error register */
{
    outstr=chan[0];
    ibwrt(load,outstr,6);
    ibwrt(load,"CLR",3);
}

ibwrt( load,"NAME?",5);          /* Get the PEL-5000G
series load specification */
    strset(rdbuf,'\0');          /* Clear rdbuf string
buffer */
    strset(spec,'\0');          /* Clear spec string buffer
*/
    ibrd(load,spec,20);
    if (spec[3] == '9')
        printf("\n PEL-5000G series specification error !");
/* Set the channel 1, preset off, current sink 1.0 amps and load on
commands to the load. */
    ibwrt( load,"chan 1;pres off;curr:low 0.0;curr:high 1.0;load on ",43);
    ibwrt( load,"meas:curr ?",10);
/* Get the load actually sink current from the load */
    ibrd( load,rdbuf,20);
/* go to local. */
    ibloc(load);
```

```
}
```

BASICA Example Program

LOAD DECL.BAS using BASICA MERGE command.

```
100 REM You must merge this code with DECL.BAS
```

```
105 REM
```

```
110 REM Assign a unique identifier to the device "dev5" and store it  
in variable load%.
```

```
125 REM
```

```
130     udname$ = "dev5"
```

```
140     CALL ibfind (udname$,load%)
```

```
145 REM
```

```
150 REM Check for error on ibfind call
```

```
155 REM
```

```
160     IF load% < 0 THEN GOTO 2000
```

```
165 REM
```

```
170 REM Clear the device
```

```
175 REM
```

```
180     CALL ibclr (load%)
```

```
185 REM
```

```
190 REM Get the PEL-5012C-600-840 load specification
```

```
195 REM
```

```
200     wrt$ = "NAME?" : CALL ibwrt(load%,wrt$)
```

```
210     rd$ = space$(20) : CALL ibrd(load%,rd$)
```

```
215 REM
```

```
220 REM Set the preset off, current sink 1.0 amps and load on  
commands to the load.
```

```
225 REM
```

```
230     wrt$ = "pres off;curr:low 0.0;curr:high 1.0;load on"
```

```
240      CALL ibwrt(load%,wrt$)
245 REM
250 REM Get the load actualy sink current from the load
255 REM
260      wrt$ = "meas:curr?" : CALL ibwrt(load%,wrt$)
270      rd$ = space$(20) : CALL ibrd(load%,rd$)
275 REM
280 REM Go to local
285 REM
290 CALL ibloc(load%)

2000 REM Error routine to notify that ibfind failed.
2010 REM Check software configuration.
2020 PRINT "ibfind error !" : STOP
```

PEL-5000G series USB Instruction

Background

1. Install the USB DRIVER select
USB\SETUP\PL-2303 Driver Installer.exe

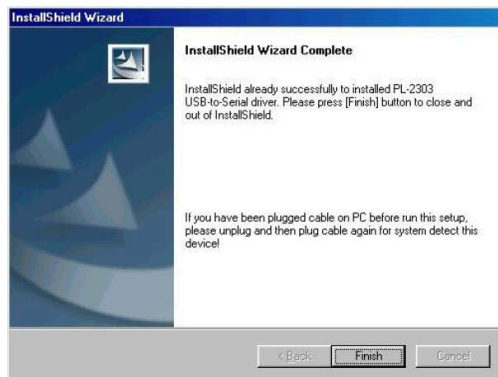
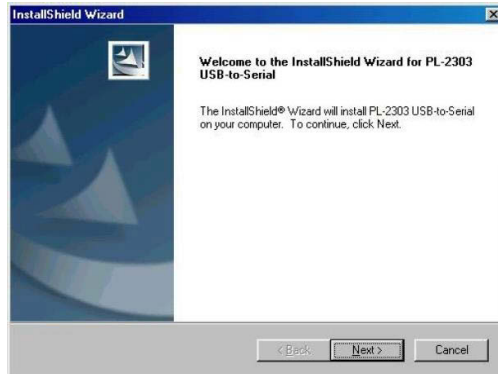

2. After the installation, connect the PEL-5000G series and PC with USB. Then select the item USB to Serial Port (COM3), set the BAUD-RATE and Flow control to 115200bps and Hardware to control PEL-5000G series with

COM3.

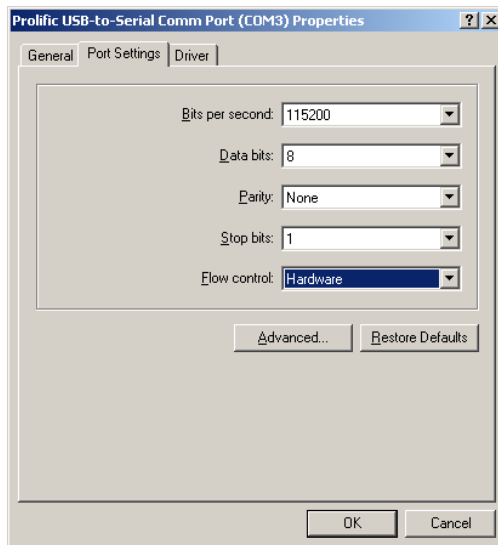
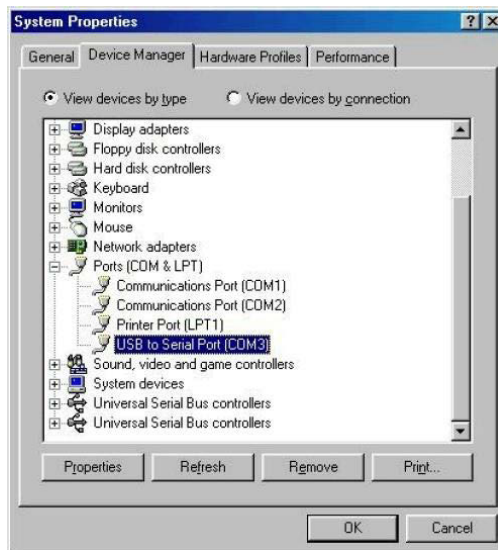

PEL-5000G series LAN Instruction

Background

1. Connecting AC power and the network line to the PEL-5000G series mainframe, connect the other Side of the network line to the HUB.
 - a. For Windows XP:

Run the ETM.EXE (This file can be downloaded from GW Instek website), it will show as fig below. If not, please press F5 to search again, or check the first step was succeed or not.

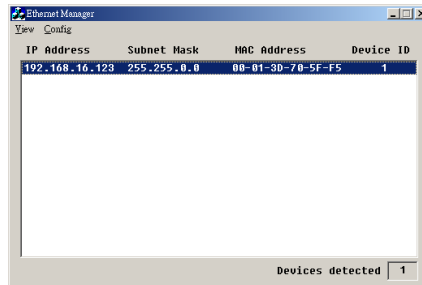

- b. For Windows 7, 8 and 10:

Run the IPScanner.EXE (This file can be downloaded from GW Instek website), If a Windows security alert appears, please select a public network, and then click "Allow Access", the following screen will appear. if not , please press F5 to search again, or check the first step was succeed or not.

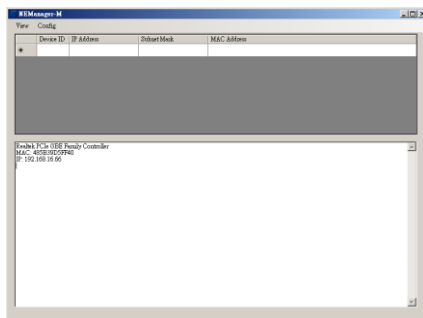

- It will be shown the installation which has been searched on the screen, click it and select the Set IP Address bellows Config:



- Set a useful IP Address and Subnet Mask.
- It will be shown the Setup Device as the following figure if all steps was corrected to be run.

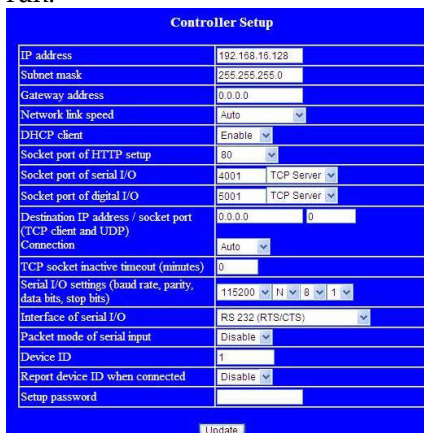

- Insert the numbers as the following:
IP Address: as recommended according to your network

- A. Subnet Mask: as recommended according to your network
- B. Gateway Address: as recommended according to your network
- C. Network link speed: Auto
- D. DHCP client: Enable
- E. Socket port of HTTP setup: 80
- F. Socket port of serial I/O: 4001, TCP Server
- G. Socket port of digital I/O: 5001, TCP Server
- H. Destination IP address/ socket port (TCP client and UDP) Connection: Auto
- I. TCP socket inactive timeout (minutes): Set the network disconnection after N minutes, set 0 minutes will work forever.
- J. Serial I/O settings (baud rate, parity, data, bits, stop bits): 115200, N, 8, 1
- K. Interface of serial I/O: RS 232 (RTS/CTS)
- L. Packet mode of serial input: Disable
- M. Device ID: 5
- N. Report device ID when connected: Auto
- O. Setup password: Not required

PEL-5000G series Auto-Sequence function provide EDIT, ENTER, EXIT, TEST and STORE 5 keys operation

Edit mode

1. Set mode, Range, current level ... Load Setting an, Load ON.
2. Press STORE key to store the load setting in memory STATE
3. Repeat 1~2, for the sequence load setting.
4. Press Shift + SEQ. key of PEL-5000G Series front panel.
5. Press up/down key to select Edit Mode.
6. Press 1~9 number key program number.
7. Press STATE up/down key to select memory state.
8. Press ENTER to next step.
9. Repeat 6~8 to edit Step of sequence
10. Press SAVE to confirm the step
11. LCD shows "rept" to setting repeat count.
12. Press up/down key to set repeat count of sequence loop.
13. Press ENTER to confirm the sequence edit.

- Test mode
1. Press Shift + SEQ. key of PEL-5000G series front panel.
 2. Press up/down key to select Test Mode.
 3. Press 1~9 number to select sequence number
 4. Press ENTER to execution the sequence
 5. The LCD shows "PASS" or "FAIL" after testing.

Auto Sequence:

Auto sequence setting command	Note	Return
FILE{SP}{n}{; NL}	n = 1~9	1 ~ 9
FILE{?}{; NL}	n = 1~9	1 ~ 9
STEP{SP}{n}{; NL}	n = 1~16	1 ~ 16
STEP{?}{; NL}	n = 1~16	1 ~ 16
TOTSTEP{SP}{n}{; NL}	Total step n = 1~16	1 ~ 16
TOTSTEP{?}{; NL}	Total step n = 1~16	1 ~ 16
SB{SP}{m}{; NL}	m = 1~150, m: STATE	
SB{?}{; NL}	m = 1~150, m: STATE	
TIME{SP}{NR2}{; NL}	100 ~ 9999(ms)	100 ~ 9999(ms)
SAVE{; NL}	Save "File n" data	
REPEAT{SP}{n}{; NL}	n = 0~9999	0 ~ 9999
REPEAT{?}{; NL}	n = 0~9999	0 ~ 9999
RUN{SP}{F}{n}{; NL}	n = 1~9	AUTO REPLY "PASS" or FAIL: XX"(XX=NG STEP)

Example Sequence In this example, we will create a program based on following Figure.

The program repeats steps 1 to 8 two times. After repeating the sequence two times, the load is turned off and the sequence ends.

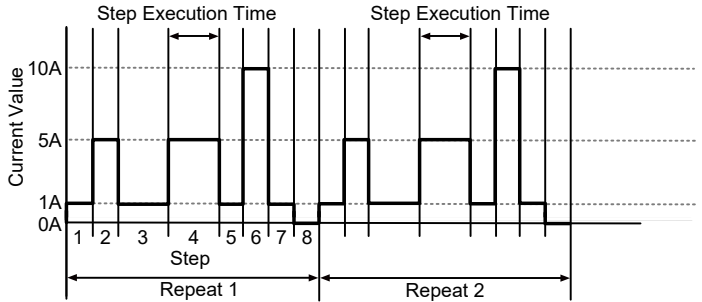

Sequence Number	Step Number	Current Value	Execution Time(T1+T2)
3	1	1A	200mS
3	2	5A	200mS
3	3	1A	400mS
3	4	5A	400mS
3	5	1A	200mS
3	6	10A	200mS
3	7	1A	200mS
3	8	0A	200mS

Creating the program

1. Setting the Load current level and store to state 1~8.
2. Set the operation mode
Press the mode key to CC mode.
3. Set the range
Press RANGE key to force range 2
4. Press Load ON
5. Set the current value as step 1~8 and store to memory state 1~8
6. Press EDIT key of PEL-5000G series mainframe
7. Press up/down key to select Edit Mode

8. Press sequence number 3 to edit the sequence.
9. Press up/down key to memory state 1
10. Press ENTER key to confirm the sequence memory
11. Press up/down key to setting execution time
12. Press ENTER key to confirm the sequence step
13. Repeat 8~12 to setting step 1~8
14. Press SAVE key to confirm step 1~8
15. Press up/down key to 1 to repeat one times.
16. Press ENTER to confirm the repeat count.

Testing Waveform

