

FLUKE®

3000 FC

Wireless Multimeter

Users Manual

May 2014, Rev. 1, 9/16

© 2014-2016 Fluke Corporation. All rights reserved. Specifications are subject to change without notice.

All product names are trademarks of their respective companies.

LIMITED WARRANTY AND LIMITATION OF LIABILITY

This Fluke product will be free from defects in material and workmanship for three years from the date of purchase. This warranty does not cover fuses, disposable batteries, or damage from accident, neglect, misuse, alteration, contamination, or abnormal conditions of operation or handling. Resellers are not authorized to extend any other warranty on Fluke's behalf. To obtain service during the warranty period, contact your nearest Fluke authorized service center to obtain return authorization information, then send the product to that Service Center with a description of the problem.

THIS WARRANTY IS YOUR ONLY REMEDY. NO OTHER WARRANTIES, SUCH AS FITNESS FOR A PARTICULAR PURPOSE, ARE EXPRESSED OR IMPLIED. FLUKE IS NOT LIABLE FOR ANY SPECIAL, INDIRECT, INCIDENTAL OR CONSEQUENTIAL DAMAGES OR LOSSES, ARISING FROM ANY CAUSE OR THEORY. Since some states or countries do not allow the exclusion or limitation of an implied warranty or of incidental or consequential damages, this limitation of liability may not apply to you.

Table of Contents

Title	Page
Introduction	1
How to Contact Fluke	1
Safety Information	1
Hazardous Voltage	5
Test Lead Alert	5
Battery Saver (Sleep Mode)	5
Wireless Radio	5
MIN MAX AVG Record Mode	6
Display Hold	7
Yellow Button	7
Display Backlight	7
Manual and Auto Range	8
Power-Up Options	8
Features	9
AC Zero Input Behavior of True-rms Meters	13

Wireless Radio Setup	13
Pair with Fluke Connect App.....	14
Pair with Wireless Test Tools.....	14
Disconnect the Wireless Radio	17
Basic Measurements	17
AC and DC Voltage Measurements	17
Volts/Hertz Ratio	19
Resistance Measurements	20
Capacitance Measurements	21
Continuity Test.....	22
AC or DC Current Measurements	23
Diode Test	25
Frequency Measurement	27
Maintenance	29
General Maintenance.....	29
Fuse Test.....	29
Battery and Fuse Replacement.....	30
Service and Parts	33
Specifications	36
AC Voltage.....	38
DC Voltage, Continuity, Resistance, Diode Test, and Capacitance	39
AC and DC Current.....	40
Frequency.....	40
Frequency Counter Sensitivity	41
Input Characteristics	42
MIN MAX Recording	42

Introduction

⚠⚠ Warning

To prevent possible electrical shock, fire, or personal injury, read all safety information before you use the Product.

The 3000 FC Wireless Multimeter (the Product) is a True-rms Digital Multimeter.

Safety Information

The Product complies with:

- ANSI/ISA-82.02.01
- CAN/CSA-C22.2 No. 61010-1-12: 3rd Edition
- UL 61010-1: 3rd Edition
- IEC/EN 61010-1:2010
- Measurement Category III, 1000V, Pollution Degree 2
- Measurement Category IV, 600V, Pollution Degree 2

A **Warning** identifies conditions and procedures that are dangerous to the user. A **Caution** identifies conditions and procedures that can cause damage to the Product or the equipment under test.

A list of symbols used on the Product and in this manual is in Table 1.

⚠⚠ Warning











To prevent possible electrical shock, fire, or personal injury:

- Carefully read all instructions.
- Do not alter the Product and use only as specified, or the protection supplied by the Product can be compromised.
- Limit operation to the specified measurement category, voltage, or amperage ratings.
- Do not use the Product around explosive gas, vapor, or in damp or wet environments.

- Do not touch voltages >30 V ac rms, 42 V ac peak, or 60 V dc.
- Do not exceed the Measurement Category (CAT) rating of the lowest rated individual component of a Product, probe, or accessory.
- Measure a known voltage first to make sure that the Product operates correctly.
- Do not use the Product if it is altered or damaged.
- Disable the Product if it is damaged.
- Do not work alone.
- Comply with local and national safety codes. Use personal protective equipment (approved rubber gloves, face protection, and flame-resistant clothes) to prevent shock and arc blast injury where hazardous live conductors are exposed.

- **Replace the batteries when the low battery indicator shows to prevent incorrect measurements.**
- **The battery door must be closed and locked before you operate the Product.**
- **Do not use the Product if it operates incorrectly.**
- **Examine the case before you use the Product. Look for cracks or missing plastic. Carefully look at the insulation around the terminals.**
- **Use only correct measurement category (CAT), voltage, and amperage rated probes, test leads, and adapters for the measurement.**
- **Do not use test leads if they are damaged. Examine the test leads for damaged insulation, exposed metal, or if the wear indicator shows. Check test lead continuity.**
- **Keep fingers behind the finger guards on the probes.**
- **Do not touch the probes to a voltage source when the test leads are connected to the current terminals.**
- **Connect the common test lead before the live test lead and remove the live test lead before the common test lead.**
- **Remove all probes, test leads, and accessories that are not necessary for the measurement.**

Table 1. Symbols

Symbol	Description	Symbol	Description
	WARNING. RISK OF DANGER.		WARNING. HAZARDOUS VOLTAGE. Risk of electric shock.
	Consult user documentation.	IR	Minimum fuse interrupt rating.
	Conforms to European Union directives.		Conforms to relevant Australian Safety and EMC standards.
	Certified by CSA Group to North American safety standards.		Fuse
	Battery		Double Insulated
	Conforms to relevant South Korean EMC standards.		
CAT II	Measurement Category II is applicable to test and measuring circuits connected directly to utilization points (socket outlets and similar points) of the low-voltage MAINS installation.		
CAT III	Measurement Category III is applicable to test and measuring circuits connected to the distribution part of the building's low-voltage MAINS installation.		
CAT IV	Measurement Category IV is applicable to test and measuring circuits connected at the source of the building's low-voltage MAINS installation.		
	This product complies with the WEEE Directive marking requirements. The affixed label indicates that you must not discard this electrical/electronic product in domestic household waste. Product Category: With reference to the equipment types in the WEEE Directive Annex I, this product is classed as category 9 "Monitoring and Control Instrumentation" product. Do not dispose of this product as unsorted municipal waste.		

Hazardous Voltage

The hazardous voltage warning  shows on the display when the Product detects a voltage ≥ 30 V.

Test Lead Alert

The display shows LEAD for 1 second when you turn the function switch to or from the mA position to remind you to make sure the test leads are in the correct terminals.

Battery Saver (Sleep Mode)

To save battery power, the Product includes a sleep mode. Sleep mode turns off the display if there is no function change or button pushed for 20 minutes. To turn off the sleep mode, push  while you turn on the Product. The sleep mode is always turned off for a MIN MAX AVG record session and when remote test tools are shown on the display.

Wireless Radio

The Product uses low-power 802.15.4 wireless radio technology to send or receive measurements to other wireless test tools or the Fluke Connect[®] app on a mobile device such as a smartphone or tablet.

You can set up to pair with:

- A mobile device. Use the Fluke Connect app to view measurements remotely, save to Fluke Cloud™ storage, and share the information with your team.
- Up to three 3000 FC Series Wireless Test Tools. Show their measurements on a single display.
- A 3000 FC Wireless Multimeter when it operates in the send mode.

The wireless radio does not cause interference with meter measurements.

Note

Changes or modifications to the wireless 2.4 GHz radio not expressly approved by Fluke Corporation could void the user's authority to operate the equipment.

See *Wireless Radio Setup* on page 13 for instructions on how to set up and use the wireless radio in the Product.

MIN MAX AVG Record Mode

The MIN MAX AVG record mode records the minimum and maximum input values, and calculates a running average of all measurements. The Product beeps when a new high or low is sensed.

Note

For dc functions, accuracy is the specified accuracy of the measurement function, ± 12 counts for changes longer than 250 ms in duration.

For ac functions, accuracy is the specified accuracy of the measurement function ± 40 counts for changes longer than 900 ms in duration.

To start a MIN MAX AVG record session:

1. Make sure the Product is set to the correct measurement function and on the correct range. Autorange is disabled while in a MIN MAX AVG record session.

2. Push **MINMAX**, **MIN MAX** and Max show at the top of the display. The measurement in the display is the maximum value measured. It changes only when a new maximum value is sensed.
3. To pause MIN MAX AVG record, push **HOLD**. **HOLD** shows on the display while record is paused. Recorded values are not deleted. To continue the record session, push **HOLD**.
4. To exit and erase the MIN, MAX, and AVG values, push **MINMAX** for 1 second or turn the rotary switch.
5. To see the other recorded values (minimum and average), push **MINMAX**. Each push of the button shows a different recorded value. The value shown in the display is identified with Max, Min, or Avg to the right of the MIN MAX icon.

Note

Sleep mode is turned off in MIN MAX AVG record mode.

Display Hold

Warning

To prevent possible electrical shock, fire, or personal injury, do not use the HOLD function to measure unknown potentials. When HOLD is turned on, the display does not change when a different potential is measured.

In the display hold mode, the Product holds the measurement in the display. All wireless test tool measurements continue to update. To hold a measurement on the display, push **HOLD**. The display shows **HOLD** when display hold is turned on.

Push **HOLD** again to stop hold mode and show measurements on the display.

Yellow Button

Push the yellow button () to set the Product to a different measurement function. The different functions are shown in yellow around the rotary switch. Frequency, mV ac, capacitance, diode test, and mA dc are functions of the Product set with the yellow button.

Display Backlight

Push  to turn on and turn off the backlight. The backlight automatically turns off after 2 minutes.

Manual and Auto Range

The Product can be set to manual or auto range. In autorange, the Product sets the range so the input is shown with the best resolution. Manual range lets you set the range.

When you turn on the Product, it is set to autorange and **Auto** shows on the display. To set the Product to manual range, push **RANGE**.



Note

*You cannot change range when the Product is in the MIN MAX AVG record mode or in display hold mode. If you push **RANGE** in one of these modes, the Product beeps twice to alert you to an invalid operation.*

Power-Up Options

To set a power-up option, hold down the button shown in Table 2 while you turn on the Product.

Table 2. Power-Up Options

Button	Power-Up Option
	Turns off the beeper.
 (yellow)	Turns off sleep mode. POFF briefly shows on the display.
	Turns off 2 minute backlight timeout. LOFF shows in the display for a second.

Features

Tables 3 through 5 are lists of Product features with descriptions.

Table 3. Inputs

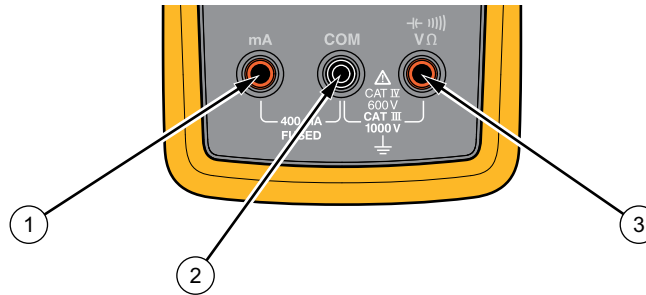

gxr001.eps

Terminal	Description
①	mA - Input for 3.00 mA to 400.0 mA current measurements and current frequency.
②	COM - Return terminal for all measurements.
③	$\frac{+}{-} \text{V} \Omega$ - Input for voltage, resistance, diode, capacitance, and voltage frequency.

Table 4. Rotary Switch Positions















Switch Position	Function
	DC voltage from 1 mV to 1000 V. Push  to measure frequency from 2 Hz to 99.99 kHz.
	AC voltage measurement from 60.0 mV to 1000 V. Push  to measure frequency from 2 Hz to 99.99 kHz. Push  again to measure Volts/Hertz.
	DC voltage measurements from 1 mV to 600 mV. Push  to measure ac voltage from 6 mV to 600 mV. ^[1]
	Resistance measurements from 0.1 Ω to 50 MΩ. Push  to measure capacitance from 1 nF to 9999 μF.
	Continuity. Beeper turns on at <25 Ω and turns off at >250 Ω. Push  for diode test. Shows OL above 2.0 V.
 	AC current measurements from 3.00 mA to 400 mA. Push  to measure dc current from 3.00 mA to 400 mA. ^[1] Push  again to measure frequency from 2 Hz to 9.99 kHz.
[1] This function stays in ac or dc when the function switch is moved to another position and back to this function. Even when turned to off and back to this function.	

Table 5. Pushbuttons







Button	Switch Position	Function
	<p>Hz ~ V</p> <p>Hz ≡ V</p> <p>~ ≡ mV</p> <p>⊕ Ω</p> <p>⊕)))</p> <p>≡ mA Hz</p>	<p>Selects frequency.</p> <p>Selects frequency.</p> <p>Selects ac millivolts. ^[1]</p> <p>Selects capacitance.</p> <p>Selects diode test.</p> <p>Push once to select dc milliamps. Push twice to select ac frequency. ^[1]</p>
<p>RANGE</p>	<p>All positions</p>	<p>Sets the Product to manual range and scrolls through each range. Push for 1 second to set the Product to autorange.</p>
<p>HOLD</p>	<p>All positions</p>	<p>Freezes the display.</p>

Table 5. Pushbuttons (cont.)

Button	Switch Position	Function
	Not related to switch position	Push once to turn on the backlight and push again to turn off the backlight. The backlight turns off automatically after 2 minutes.
	All positions	Starts the MIN MAX record function. Steps the display through MAX, MIN, AVG (average), and input signal measurement. Push for 1 second to stop MIN MAX record.
	Not related to switch position	Selects the highlighted radio mode and selects/deselects the highlighted wireless test tool on the display. ^[2]
	Not related to switch position	<ul style="list-style-type: none"> • Moves the highlight on the display to the next radio mode or wireless test tool shown in the display. • Hold for 1 second to pair all selected test tools to the Product and stop the discovery procedure.^[2]
	Not related to switch position	<ul style="list-style-type: none"> • Turns on the radio and shows the radio mode selection screen.  shows on the display when the radio is on. • In App mode, sends the measurement to the Fluke Connect App on mobile device. • Push and hold for 1 second to turn off the radio when radio is on.^[2]
<p>[1] This function stays in ac or dc when the function switch is moved to another position and back to this function. Even when turned to off and back to this function.</p> <p>[2] This button is used when the Product connects with a wireless radio. See <i>Wireless Radio Setup</i> on page 13 to learn more.</p>		

AC Zero Input Behavior of True-rms Meters

Average responding meters can accurately measure only pure sinewaves. A True-rms meter can accurately measure distorted waveform signals. A minimum input voltage is necessary for calculating True-rms converters to make a measurement. Because of this minimum input, True-rms meter specifications are only good for 1 % to 100 % of range. Non-zero digits that are shown on a True-rms meter when the test leads are open or are shorted are possible. This has no effect on the ac measurement accuracy of signals that are more than 1 % of range.

Unspecified input levels on the lowest ranges are:

- AC voltage less than 1 % of 600 mV ac or 6 mV ac.
- AC current less than 5 % of 60 mA ac or 3 mA ac.

Wireless Radio Setup

The Product uses wireless radio technology to send or receive measurements to other wireless test tools or the Fluke Connect[®] app. The range of the radio is up to 20 m (66 ft).

The term “discovery” in this manual refers to a procedure the Product does to look for compatible radio signals. The term “pair with” means the Product has made a wireless connection to a test tool or the Fluke Connect[®] app on your mobile device.

To turn on the radio:

1. Turn on the Product (the radio is off at the initial power on).
2. Push  to turn on the radio.

When you turn on the radio:

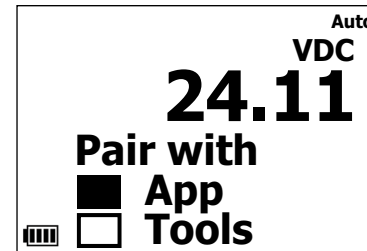

- the  LED turns on and is a steady blue
- the radio mode selection screen shows





Pair with Fluke Connect App

When the Product radio is set to the App (send) mode, you can use the Fluke Connect app on a mobile device to view, save, and share measurements.

To pair with the Fluke Connect app:

1. Turn on the Product (the radio is off at the initial power on).
2. Push  to turn on the radio.
3. Push  to highlight the **App** (send) option. The display shows the radio mode selection screen.
4. Push **SELECT** to enable the App selection.

When in the App (send) mode:

- the  icon shows on the display
- the  LED blinks at 4 to 5 second intervals

On your mobile device:

1. Go to **Settings > Bluetooth**. Verify that Bluetooth is turned on.
2. Go to the Fluke Connect app and in the list of connected Fluke tools, select **3000 FC**.

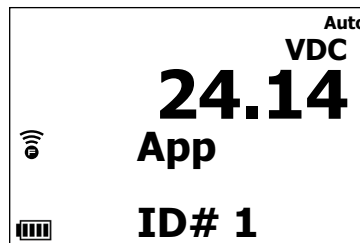

On the Product, the display updates to show the ID# (1 through 10).



Pair with Wireless Test Tools

When the radio is set to the Tools (receive) mode, the Product can discover up to 6 test tools and then pair with up to 3 wireless test tools. The live measurements show on the display from all paired tools.



Before you start the discovery procedure:

1. Push  and make sure the radio in each test tool is turned on.
 shows on the test tool display when the radio is on.
2. Turn on the Product (the radio is off at the initial power on).
3. Push  to turn on the radio. The display shows the radio mode selection screen.

To start the discovery procedure:

1. Push **↔** to highlight the **Tools** (receive) option.
2. Push **SELECT** to enable the Tools selection and start the discovery procedure.

When the discovery procedure starts:

- the  icon shows on the display
- the  button blinks at 4 to 5 second intervals
- display updates to show Tools and a series of dots to indicate that discovery is in progress

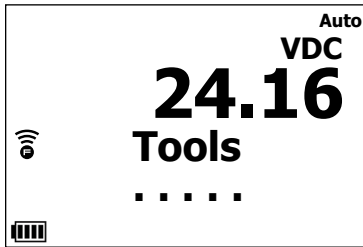

Note

If no radio signals are discovered after 2 minutes, the radio in the Product turns off.

When the discovery procedure is complete:

- the  icon shows on the display
- display updates to show a list of test tools with the ID number and the model name
- arrow icon on the display indicates a scrollable list for more selections (up to 6)
- a blinking ID number indicates the highlighted selection

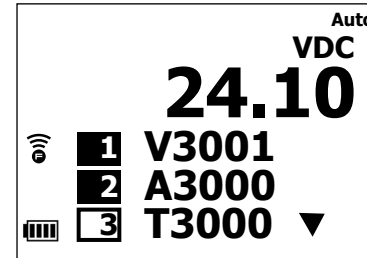

You can select up to 3 test tools and show their measurements on the Product display. The Product stays in the test tool selection mode for approximately 2 minutes.

To select a test tool:

1. Push  to move the highlight to the next ID number in the list.

Note

The radio button () on the test tool that is highlighted in the list flashes at a faster rate. This helps to identify the test tool.

2. Push **SELECT**. The highlight of the selected ID number is inverted.



You can wait for the selection time to complete (~2 min.) or push and hold  for 1 second to end the selection mode.

3. Repeat steps 1 and 2 to select up to 3 test tools.



Note

To pair with a test tool after the discovery procedure has completed, turn off the radio. Turn on the radio to restart the discovery procedure.

When in the Tool (receive) mode:

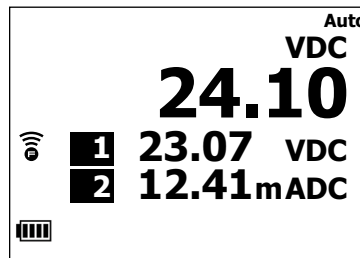

- display updates to show the live measurement of the selected test tool (up to 3)
- the  button blinks at 4 to 5 second intervals on the Product and each selected test tool
- the  button on each non-selected test tool does not blink



To verify which measurement in the display of the Product belongs to which test tool, look for the test tool with the same ID number on its display. Or, push  to highlight a test tool in the list. The  button on the test tool blinks at a faster rate.

Disconnect the Wireless Radio

You can use any one of these methods to disconnect a test tool radio from the Product.

- Turn off the test tool.
- Push  on the test tool to turn off the radio in the test tool. The test tool remains turned on to continue measurements.
- Push  on the Product to select the test tool to disconnect and then push **SELECT**. All other test tools stay paired to the Product.

Basic Measurements



Warning

To prevent possible electrical shock, fire, or personal injury, disconnect power and discharge all high-voltage capacitors before you measure resistance, continuity, capacitance, or a diode junction.

The figures that follow show how to make basic measurements with the Product.

When you connect the test leads to the circuit or device, connect the common (COM) test lead before the live lead. When you remove the test leads, remove the live lead before the common test lead.

AC and DC Voltage Measurements

The voltage ranges are 600.0 mV, 6.000 V, 60.00 V, 600.0 V, and 1000 V. To set the 600.0 mV dc or ac range, turn the function switch to . Push  to toggle the Product between millivolts dc and millivolts ac. Refer to Figure 1 to measure ac or dc voltage.

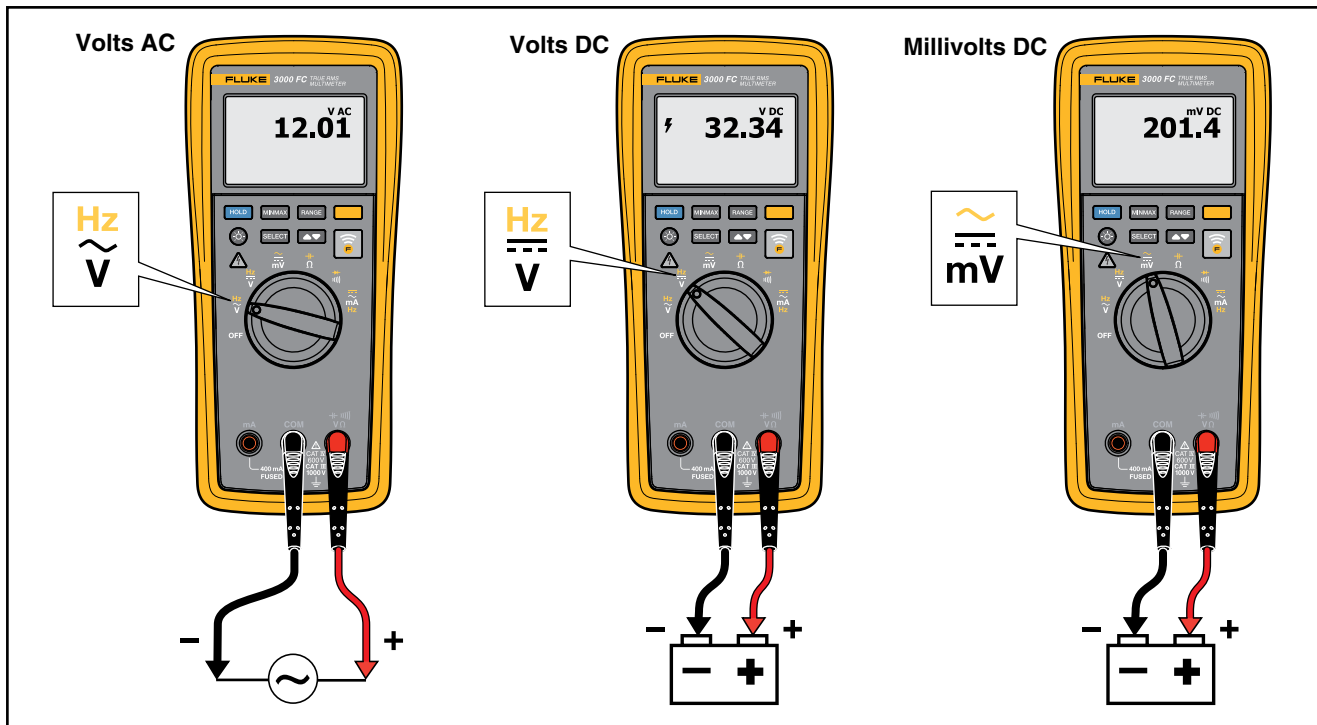

Figure 1. AC and DC Voltage Measurements

gxr002.eps

Volts/Hertz Ratio

The Product can show the ratio of volts to frequency of an ac signal. Set the Product as shown in Figure 2 to show Volts/Hertz ratio.

When the Product is set to the Volts/Hz function, the voltage range is set to manual. If the voltage increases to a value larger than the range, the Product shows **OL** in the display. If the voltage drops to less than 5 % of the range, the value shown in the display can be invalid. Set the Product as shown in Figure 2 to measure volts/Hz.

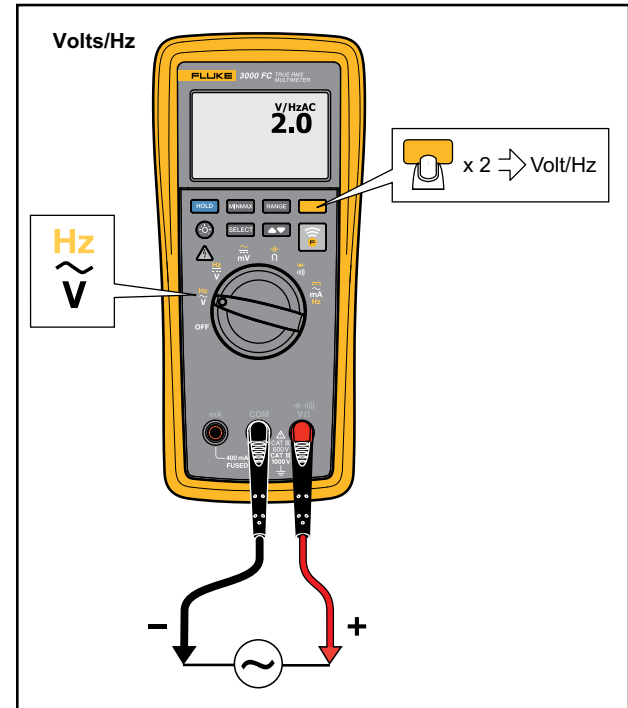

gxr011.eps

Figure 2. Volt/Hertz Ratio

Resistance Measurements

⚠ ⚠ Warning

To prevent possible electrical shock, fire, or personal injury, disconnect power and discharge all high-voltage capacitors before you measure resistance, continuity, capacitance, or a diode junction.

The Product sends a small current through the circuit for resistance measurements. Because the current flows through all possible paths between the probes, the resistance measured is the total resistance of all paths between the probes.

The resistance ranges are 600.0 Ω , 6.000 k Ω , 60.00 k Ω , 600.0 k Ω , 6.000 M Ω , and 50.00 M Ω . Set the Product as shown in Figure 3 to measure resistance.

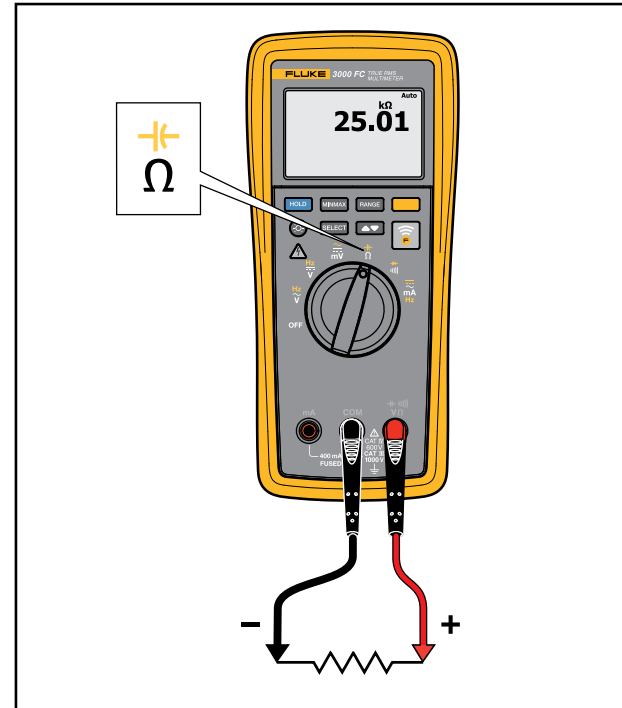

gxr003.eps

Figure 3. Resistance Measurements

Capacitance Measurements

⚠⚠ Warning

To prevent possible electrical shock, fire, or personal injury, disconnect power and discharge all high-voltage capacitors before you measure resistance, continuity, capacitance, or a diode junction.

Capacitance ranges are 1,000 nF, 10.00 μ F, 100.0 μ F, and 9999 μ F. To measure capacitance, set up the Product as shown in Figure 4.

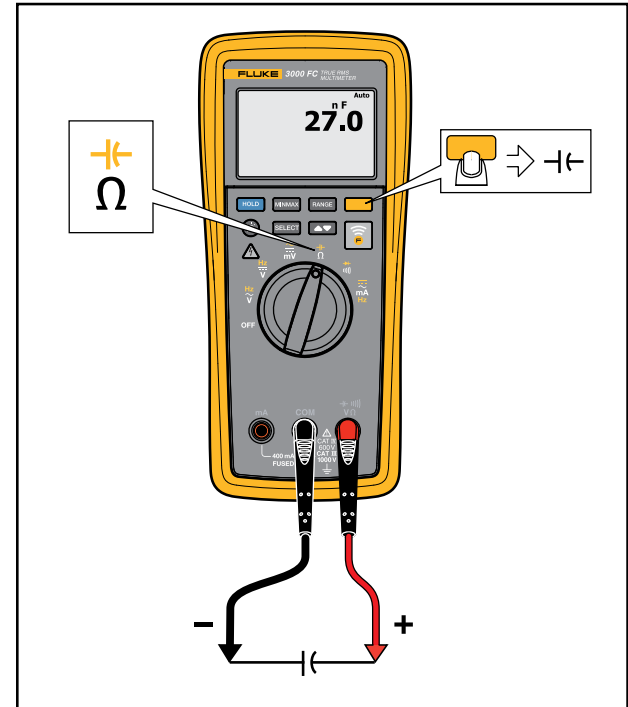

gxr004.eps

Figure 4. Capacitance Measurements

Continuity Test

⚠⚠ Warning

To prevent possible electrical shock, fire, or personal injury, disconnect power and discharge all high-voltage capacitors before you measure resistance, continuity, capacitance, or a diode junction.

The continuity test uses a beeper that sounds when a closed circuit is sensed. The beeper lets you do continuity tests without the necessity to look at the display. To do a continuity test, set up the Product as shown in Figure 5.

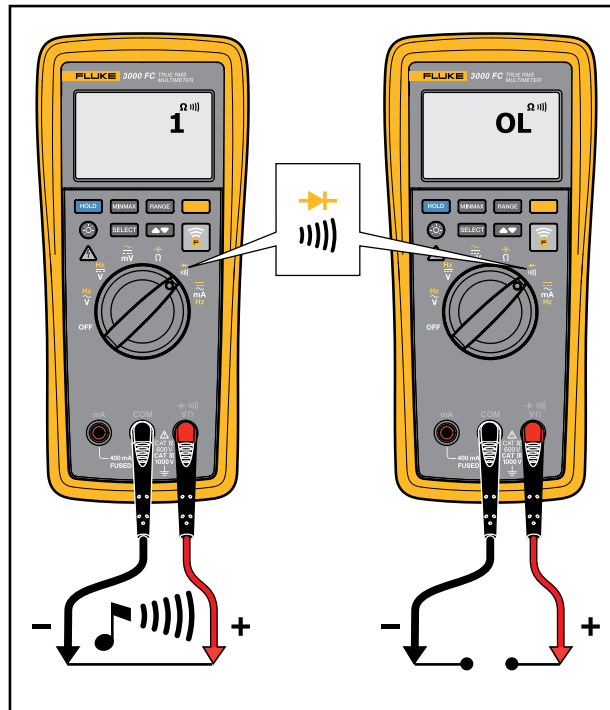

gxr005.eps

Figure 5. Continuity Tests

AC or DC Current Measurements

⚠⚠ Warning

To prevent possible electrical shock, fire, or personal injury:

- **Remove circuit power before you connect the Product in the circuit when you measure current. Connect the Product in series with the circuit.**
- **Limit operation to the specified measurement category, voltage, or amperage ratings.**

⚠ Caution

To prevent possible damage to the Product or the equipment under test:

- **Do a fuse test before current measurements. See “Fuse Test”.**
- **Use the correct terminals, function, and range for all measurements.**
- **Do not put the probes across (in parallel with) a circuit or component when the test leads are connected to the current terminals.**

Turn off circuit power, break the circuit, put the Product in series, and then turn on circuit power.

The current ranges are 60.00 mA and 400.0 mA. Set the Product as shown in Figure 6 to measure ac and dc current. Push  to toggle the Product between milliamps ac and milliamps dc.

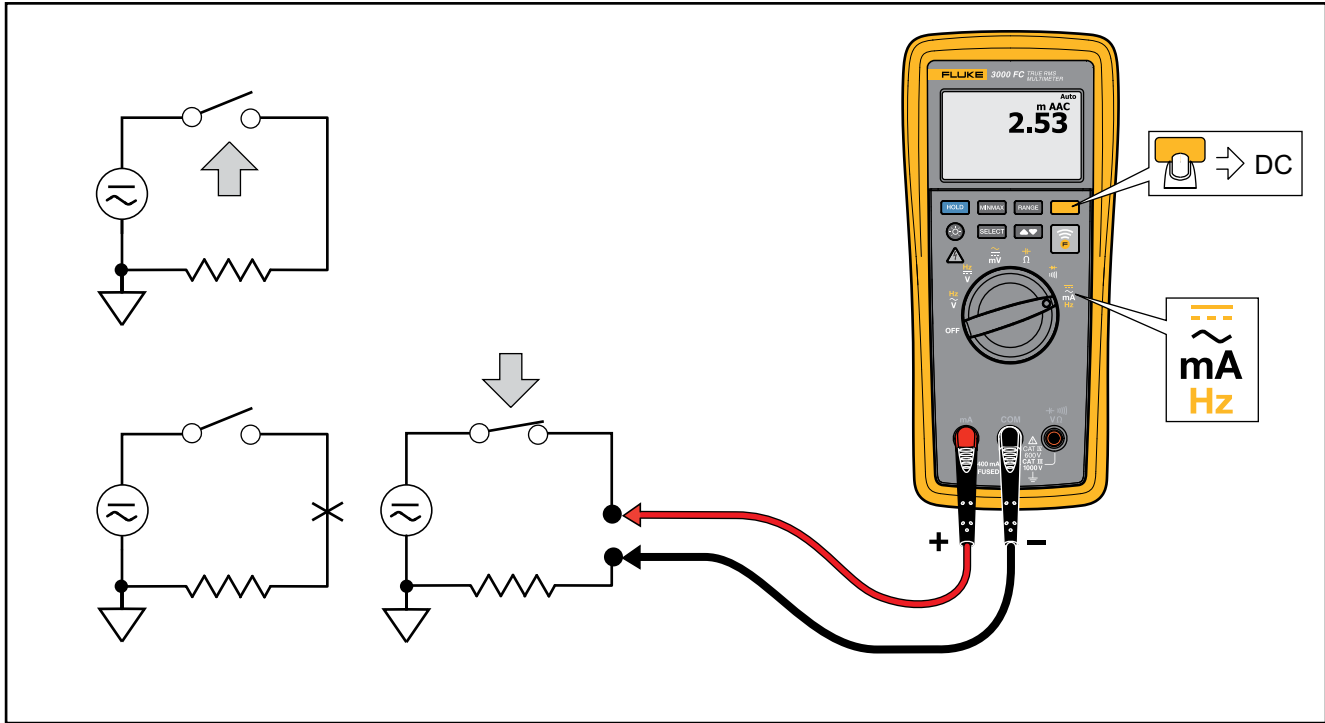

Figure 6. AC and DC Current Measurements

gxr007.eps

Diode Test

⚠⚠ Warning

To prevent possible electrical shock, fire, or personal injury, disconnect power and discharge all high-voltage capacitors before you measure resistance, continuity, capacitance, or a diode junction

Do a diode test on diodes, transistors, silicon controlled rectifiers (SCRs), and other semiconductor devices. The function sends a current through the semiconductor junction and then measures the voltage drop across the junction. A good silicon junction drops between 0.5 V and 0.8 V.

To do a diode test on a diode out of circuit, set up the Product as shown in Figure 7. For forward-bias measurements on a semiconductor component, put the red test lead on the positive terminal of the component and put the black test lead on the negative terminal of the component.

In a circuit, a good diode has a forward-bias measurement of 0.5 V to 0.8 V. A reverse-bias measurement includes the resistance of other pathways between the probes.

A short beep sounds if the diode is good (<0.85 V). A continuous beep sounds if the measurement is ≤ 0.100 V or a short circuit. The display shows **OL** if the diode is open.

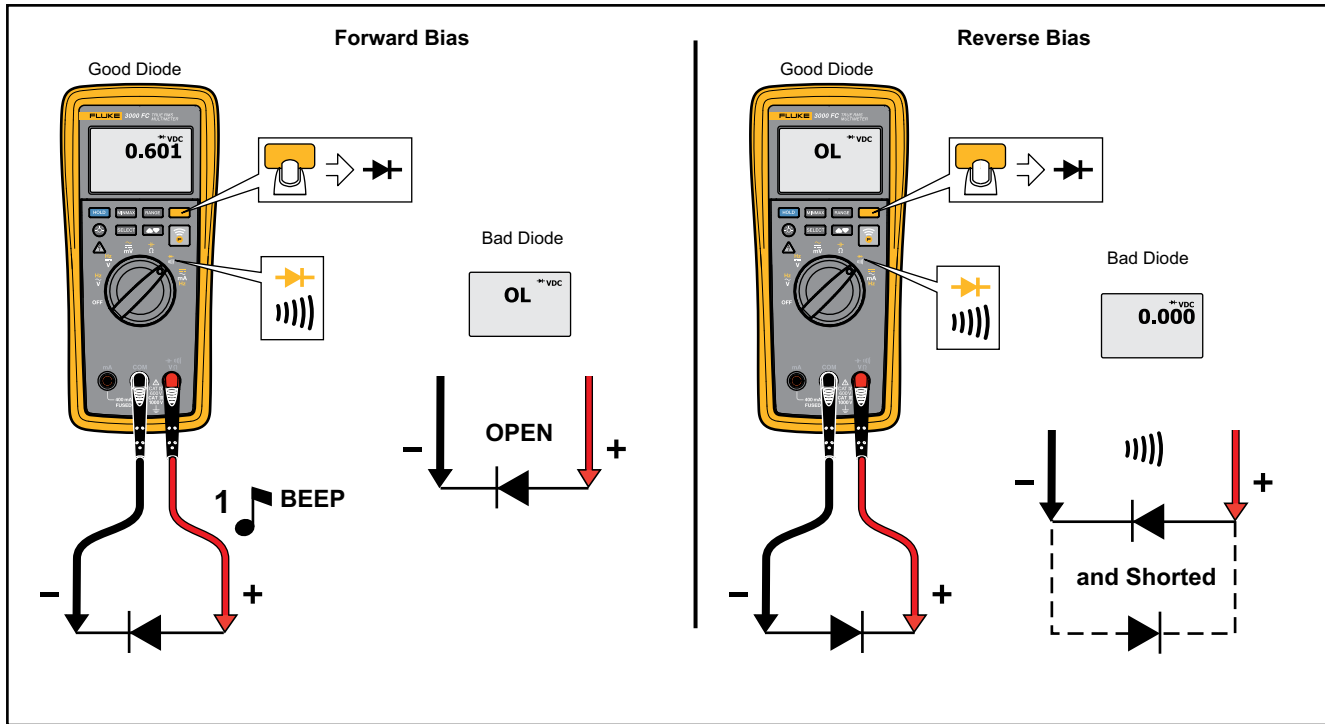

Figure 7. Diode Test

gxr006.eps

Frequency Measurement

A frequency measurement is a count of the number of times an ac voltage or current signal passes through a threshold point each second.

The Product autoranges to one of four frequency ranges: 99.99 Hz, 999.9 Hz, 9.999 kHz, and 99.99 kHz.

Hints for frequency measurements:

- If a measurement shows 0 Hz or is not stable, the input signal can be below or near a trigger level. A lower range increases the sensitivity of the Product and can usually repair these problems.
- An input signal with distortion can cause a frequency measurement to be higher than usual. The distortion can cause the frequency counter to sense multiple triggers. A higher voltage range decreases the input sensitivity and can correct this problem. In general, the lowest frequency is the correct one.

Set up the Product as shown in Figure 8 to measure frequency.

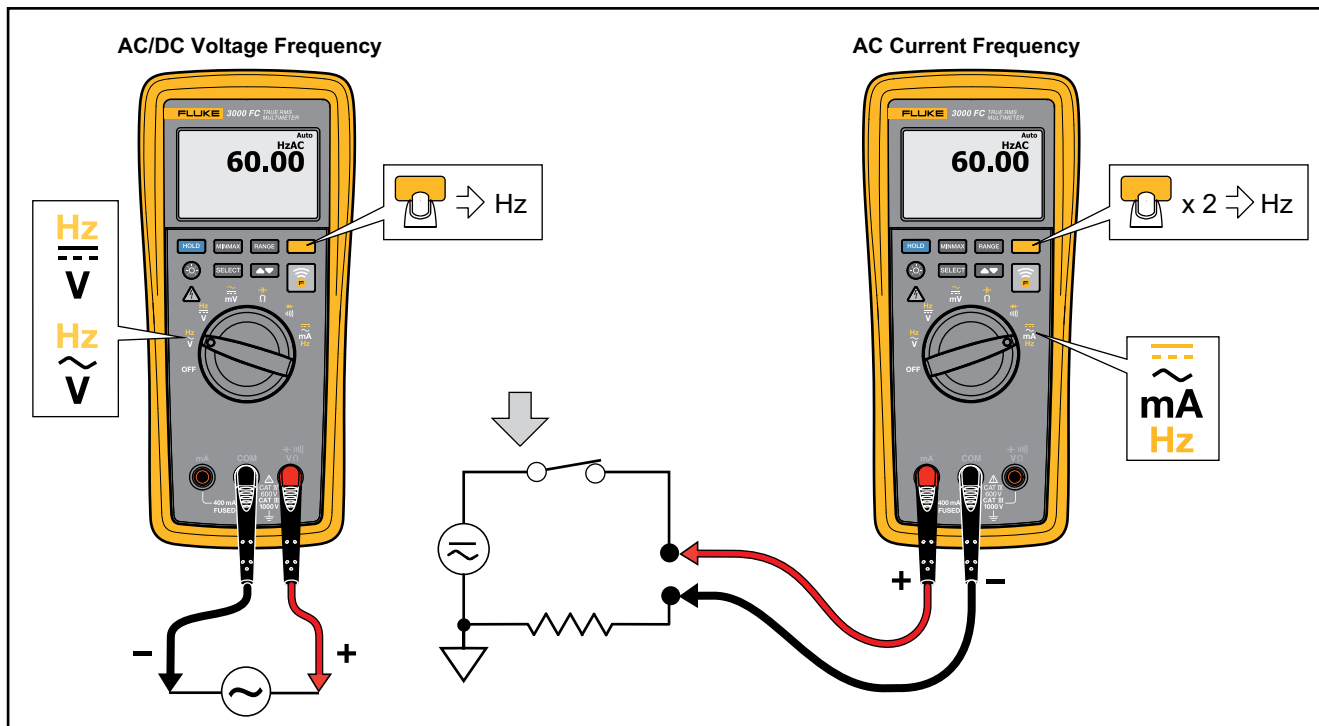

gxr008.eps

Maintenance

Warning

To prevent a possible electrical shock or personal injury:

- Have an approved technician repair the Meter.
- Do not operate the Product with covers removed or the case open. Hazardous voltage exposure is possible.
- Use only specified replacement parts.
- Remove the input signals before you clean the Product.

General Maintenance

Clean the case with a damp cloth and weak detergent. Do not use a solvent or cleaners with abrasives.

Dirt or moisture in the terminals can cause incorrect measurements. To clean the terminals:

1. Turn off the Product and remove all test leads.
2. Shake out dirt that can possibly be in the terminals.
3. Soak a clean swab with weak detergent and water.
4. Move the swab around in each terminal.

5. Dry each terminal with canned air to push the water and detergent out of the terminals.

Warning

To prevent electrical shock or personal injury, remove the test leads and all input signals before you replace the batteries or fuses. To prevent damage or injury, install **ONLY** specified replacement parts shown in Table 6.

Fuse Test

To do a fuse test:

1. Set the function switch to $\frac{*}{\Omega}$.
2. Connect a test lead to the $\frac{*}{V_{\Omega}}$ jack as shown in Figure 9.
3. Touch the other end of the test lead to the mA jack.

A good fuse will show a resistance of 12 Ω or less. Replace the fuse if the resistance is higher or shows **OL**.

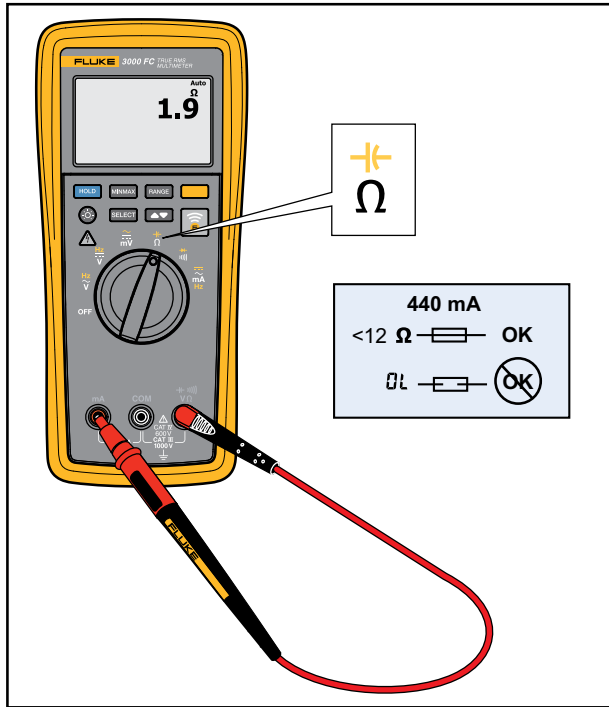

gxr009.eps

Figure 9. Fuse Test

Battery and Fuse Replacement

⚠ ⚠ Warning

To prevent possible electrical shock, fire, or personal injury:

- Replace a blown fuse with exact replacement only for continued protection against arc flash.
- Use only specified replacement fuses.
- Remove the batteries if the Product is not used for an extended period of time, or if stored in temperatures above 50 °C. If the batteries are not removed, battery leakage can damage the Product.
- Repair the Product before use if the battery leaks.
- Be sure that the battery polarity is correct to prevent battery leakage.
- Batteries contain hazardous chemicals that can cause burns or explode. If exposure to chemicals occurs, clean with water and get medical aid.

To replace the batteries:

1. Turn off the Product and remove all test leads.
2. Lift the tilt stand up as shown in Figure 10.
3. Turn the battery-door latch until the unlock symbol (🔓) aligns with the arrow.
4. Lift off the battery door.
5. Remove the three AA batteries and replace them with new ones. Use the correct battery orientation.
6. Install the battery door.
7. Turn the battery-door latch until the locked symbol (🔒) aligns with the arrow.

To replace the fuse:

1. Turn off the Product and remove all test leads.
2. As shown in Figure 10, remove six screws from the case bottom.
3. Pull the case bottom from the case top.
4. Remove the fuse from its holder and replace it with a 440 mA, 1000 V FAST fuse with a minimum interrupt rating of 10,000 A. See Table 6.

To reassemble the Product, do the steps in the opposite sequence.

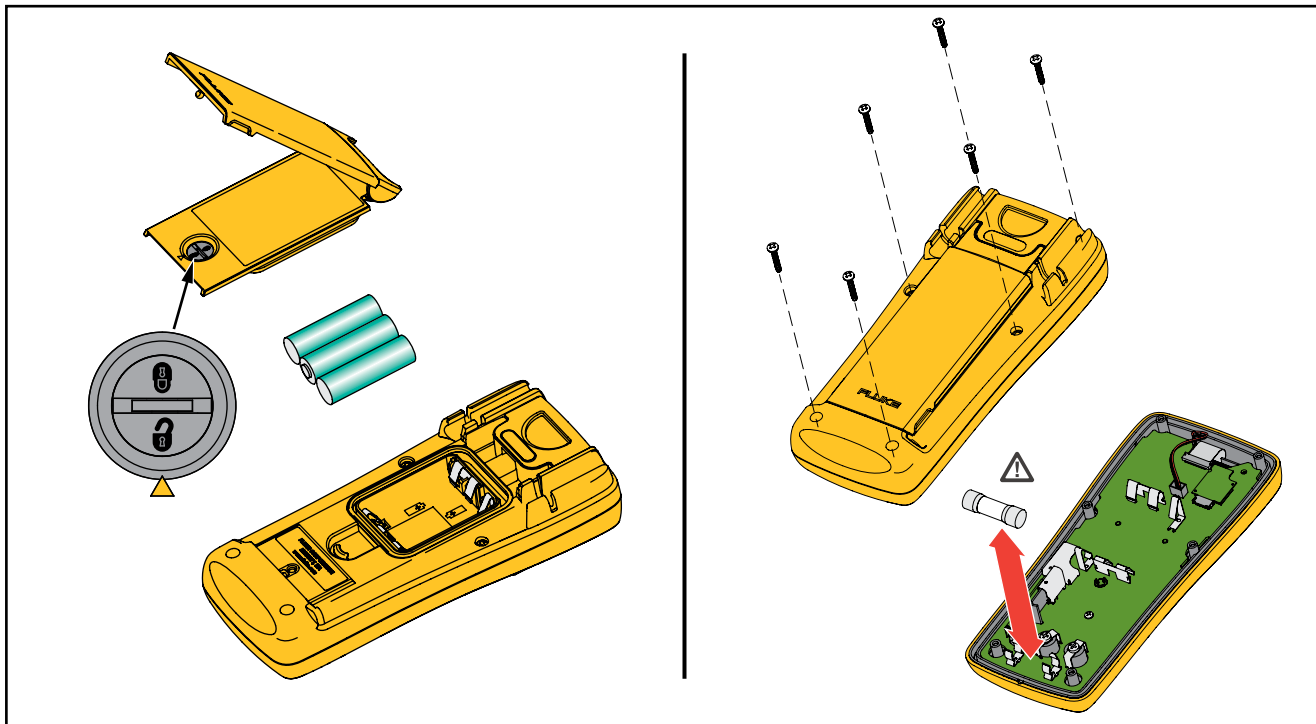

gxr010.eps

Figure 10. Battery and Fuse Replacement

Service and Parts

If the Product fails, replace the batteries and do a fuse test.

Replacement parts and accessories are shown in Table 6 and Figure 11.

To get parts and accessories, refer to the *How to Contact Fluke* section.

Table 6. Replaceable Parts

Description	Qty.	Fluke Part or Model Number
⚠ Fuse, 440 mA, 1000 V	1	943121
Battery, AA 1.5 V	3	376756
Battery Door Assembly (includes tilt stand)	1	4207624
Gasket, Battery Door	1	4137532
Test Lead Set	1	TL175
Alligator Clip, Black	1	AC175
Alligator Clip, Red	1	
3000 FC DMM Quick Reference Guide	1	4231002
3000 FC DMM Safety Information	1	4231677
⚠ To ensure safety, use exact replacement only.		

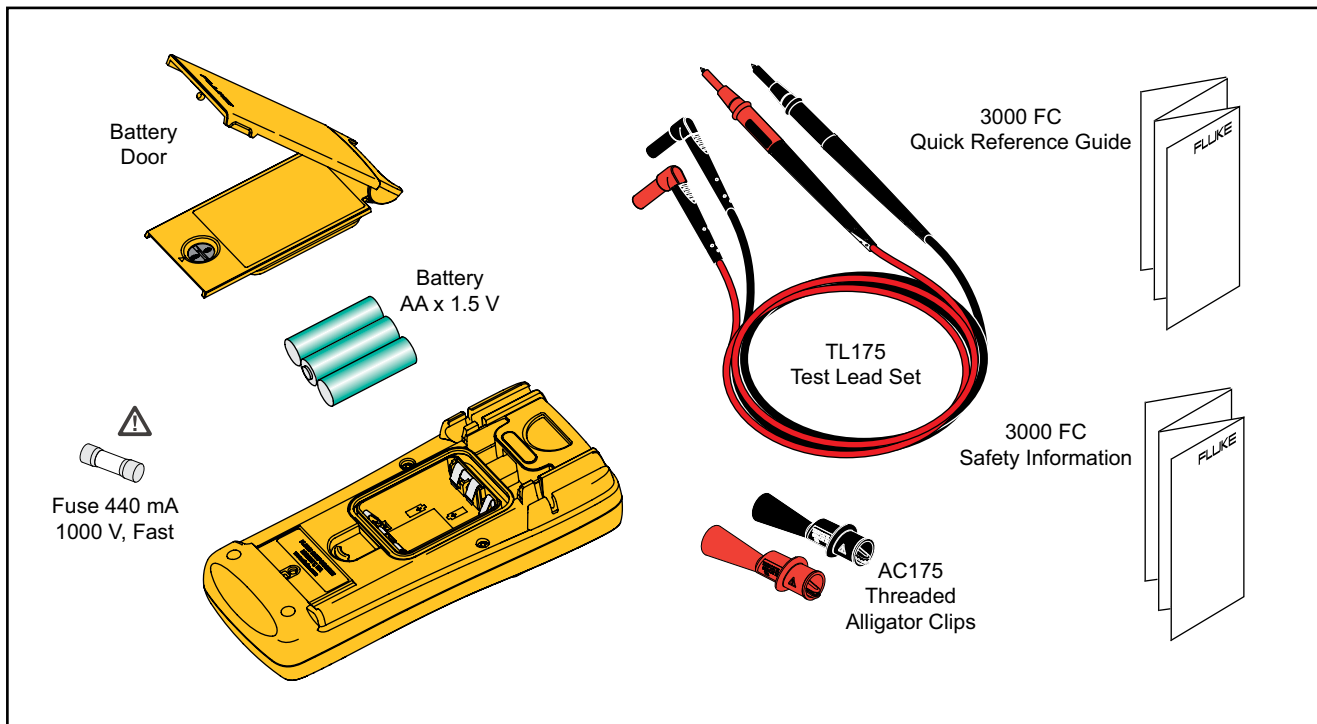

Figure 11. Replacement Parts

gxr012.eps

Table 7. Accessories

Item	Description
TPAK	ToolPak Magnetic Hanger
FLK-A3000 FC	a3000 FC Wireless AC Clamp – Measure ac current to 400 amps
FLK-A3001 FC	a3001 FC Wireless iFlex – Measures ac current to 2500 amps
FLK-A3002 FC	a3002 FC Wireless AC/DC Clamp – Measures ac/dc current with either i410 or i1010 Current Clamps
FLK-A3003 FC	a3003 FC Wireless DC Clamp – Measures from 4 mA dc to 20 mA dc
FLK-A3004 FC	a3004 FC Wireless DC Clamp – Measures from 10 A dc to 2000 A dc
FLK-T3000 FC	t3000 FC Wireless K-Type Thermometer – Measures temperature with a k-type thermocouple from -200 °C to 1372 °C
FLK-V3000 FC	v3000 FC Wireless AC Voltage – Measures ac voltage to 1000 V ac
FLK-V3001 FC	v3001 FC Wireless DC Voltage – Measures dc voltage to 1000 V dc
FLK-PC3000 FC	pc3000 FC PC Adapter
FLK-IR3000 FC	BLE-IR Adapter
FLK-C3004 IND	Deluxe tool bag with shoulder strap
FLK-CNX 3001	Modular test tool case
FLK-CNX 3002	Modular DMM case
FLK-CNX 3003	Modular 3-compartment case

Specifications

Maximum voltage between any

Terminal and Earth Ground 1000 V

Frequency Overload Protection $\leq 10^7$ V-Hz

⚠ Fuse Protection for mA inputs 0.44 A, 1000 V, IR 10 kA

Display

Update rate 4/sec

Volts, amps, ohms, 6000 counts

Frequency 10 000 counts

Capacitance 1000 counts

Battery Type Three AA Alkaline batteries, NEDA 15A IEC LR6

Battery Life 250 hours minimum

Temperature

Operating -10 °C to +50 °C

Storage -40 °C to +60 °C

Relative Humidity 0 % to 90 % (0 °C to 35 °C), 0 % to 75 % (35 °C to 40 °C), 0 % to 45 % (40 °C to 50 °C)

Altitude

Operating ≤ 2000 m

Storage $\leq 12\ 000$ m

Temperature Coefficient 0.1 X (specified accuracy) /°C (<18 °C or >28 °C)

Wireless Frequency 2.4 GHz ISM Band 20 meter range

Size (HxWxL) 4.75 cm x 9.3 cm x 20.7 cm (1.87 in x 3.68 in x 8.14 in)

Weight 487.5 g (17.2 oz)

Safety

- General.....IEC 61010-1: Pollution Degree 2
- MeasurementIEC 61010-2-033: CAT IV 600 V / CAT III 1000 V

Electromagnetic Compatibility (EMC)

- InternationalIEC 61326-1: Portable Electromagnetic Environment, IEC 61326-2-2
CISPR 11: Group 1, Class A

Group 1: Equipment has intentionally generated and/or uses conductively-coupled radio frequency energy that is necessary for the internal function of the equipment itself.

Class A: Equipment is suitable for use in all establishments other than domestic and those directly connected to a low-voltage power supply network that supplies buildings used for domestic purposes. There may be potential difficulties in ensuring electromagnetic compatibility in other environments due to conducted and radiated disturbances.

Caution: This equipment is not intended for use in residential environments and may not provide adequate protection to radio reception in such environments.

Emissions that exceed the levels required by CISPR 11 can occur when the equipment is connected to a test object.

- Korea (KCC).....Class A Equipment (Industrial Broadcasting & Communication Equipment)

Class A: Equipment meets requirements for industrial electromagnetic wave equipment and the seller or user should take notice of it. This equipment is intended for use in business environments and not to be used in homes.

- USA (FCC)47 CFR 15 subpart B. This product is considered an exempt device per clause 15.103.Detailed Specifications

For all specifications:

Accuracy is specified for 1 year after calibration, at operating temperatures of 18 °C to 28 °C, with relative humidity at 0 % to 90 %. Accuracy specifications take the form of \pm ([% of Reading] + [Number of least significant digits]).

AC Voltage

Range ^[1]	Resolution	Accuracy ^{[2][3][4]}	
		45 Hz to 500 Hz	500 Hz to 1 kHz
600.0 mV	0.1 mV	1.0 % + 3	2.0 % + 3
6.000 V	0.001 V		
60.00 V	0.01 V		
600.0 V	0.1 V		
1000 V	1 V		
<p>[1] All ac voltage ranges are specified from 1 % of range to 100 % of range. [2] Crest factor of ≤ 3 at 4000 counts, decreasing linearly to 1.5 at full scale. [3] For non-sinusoidal waveforms, add $-(2\% \text{ of reading} + 2\% \text{ full scale})$ typical, for crest factor up to 3. [4] Do not exceed 10^7 V-Hz</p>			

DC Voltage, Continuity, Resistance, Diode Test, and Capacitance

Function	Range	Resolution	Accuracy
$\overline{\text{mV}}$	600.0 mV	0.1 mV	0.09 % + 2
$\overline{\text{V}}$	6.000 V	0.001 V	0.09 % + 2
	60.00 V	0.01 V	
	600.0 V	0.1 V	
	1000 V	1 V	0.15 % + 2
 	600 Ω	1 Ω	Meter beeps at <25 Ω , beeper detects opens or shorts of 250 μs or longer.
Ω	600.0 Ω	0.1 Ω	0.5 % + 2
	6.000 k Ω	0.001 k Ω	0.5 % + 1
	60.00 k Ω	0.01 k Ω	
	600.00 k Ω	0.1 k Ω	
	6.000 M Ω	0.001 M Ω	
	50.00 M Ω	0.01 M Ω	1.5 % + 3
Diode Test	2.000 V	0.001 V	1 % + 2
⎓	1000 nF	1 nF	1.2 % + 2
	10.00 μF	0.01 μF	
	100.0 μF	0.1 μF	
	9999 μF ^[1]	1 μF	10 % typical

[1] In the 9999 μF range for measurements to 1000 μF , the measurement accuracy is 1.2 % + 2.

AC and DC Current

Function	Range ^[1]	Resolution	Accuracy
$\tilde{\text{mA}}$ (45 Hz to 1 kHz)	60.00 mA	0.01 mA	1.5 % + 3
	400.0 mA ^[3]	0.1 mA	
mA_{DC} ^[2]	60.00 mA	0.01 mA	0.5 % + 3
	400.0 mA ^[3]	0.1 mA	
[1] All ac current ranges are specified from 5 % of range to 100 % of range. [2] Input burden voltage (typical): 400 mA input 2 mV/mA. [3] 400.0 mA accuracy specified up to 600 mA overload.			

Frequency

Range	Resolution	Accuracy ^[1]
99.99 Hz	0.01 Hz	0.1 % + 1
999.9 Hz	0.1 Hz	
9.999 kHz	0.001 kHz	
99.99 kHz	0.01 kHz	
[1] Frequency is specified up to 99.99 kHz in volts and up to 10 kHz in amps.		

Frequency Counter Sensitivity

Input Range ^{[1][2]}		Typical Sensitivity (RMS Sine Wave)				
		2 Hz to 45 Hz	45 Hz to 10 kHz	10 kHz to 20 kHz	20 kHz to 50 kHz	50 kHz to 100 kHz
\tilde{V}	6 V	0.5 V	0.6 V	1.0 V	2.8 V	Unspecified ^[3]
	60 V	5 V	3.8 V	4.1 V	5.6 V	9.6 V
	600 V	50 V	36 V	39 V	50 V	58 V
	1000 V	500 V	300 V	320 V	380 V	NA
$\overline{\tilde{V}}$	6 V	0.5 V	0.75 V	1.4 V	4.0 V	Unspecified ^[3]
	60 V	4 V	3.8 V	4.3 V	6.6 V	13 V
	600 V	40 V	36 V	39 V	45 V	58 V
	1000 V	500 V	300 V	320 V	380 V	NA
\tilde{mA}	60.00 mA	5 mA	4 mA	NA	NA	NA
	400.0 mA	5 mA	4 mA	NA	NA	NA

[1] Maximum input for specified accuracy = 10X Range or 1000 V.
 [2] Noise at low frequency and amplitude may exceed the frequency accuracy specification.
 [3] Unspecified but usable depending on quality and amplitude of signal.
 [4] In mA and A ranges, frequency measurement is specified to 10 kHz.

Input Characteristics

Function	Overload Protection	Input Impedance (nominal)	Common Mode Rejection Ratio (1 k Ω unbalance)		Normal Mode Rejection
$\overline{\text{V}}$	1100 V rms	>10 M Ω <100 pF	>120 dB at dc, 50 Hz or 60 Hz		>60 dB at 50 Hz or 60 Hz
$\tilde{\text{V}}$	1100 V rms	>10 M Ω <100 pF	>60 dB, dc to 60 Hz		
$\tilde{\text{mV}}$	1100 V rms	>10 M Ω <100 pF	>120 dB at dc, 50 Hz or 60 Hz		>60 dB at 50 Hz or 60 Hz
		Open Circuit Test Voltage	Full Scale Voltage		Typical Short Circuit Current
			To 6 M Ω	50 M Ω	
$\Omega / \text{---}$	1100 V rms	<2.7 V dc	<0.7 V dc	<0.9 V dc	<350 μ A
$\text{ }) / \text{---}$	1100 V rms	<2.7 V dc	2.000 V dc		<1.1 mA

Function	Overload Protection	Overload
mA	Fused, 44/100 A, 1000 V FAST Fuse	600 mA overload for 2 minutes maximum, 10 minutes rest minimum

MIN MAX Recording

Function	Accuracy
DC Functions	The specified accuracy of the measurement function ± 12 counts for changes >350 ms in duration.
AC Functions	The specified accuracy of the measurement function ± 40 counts for changes >900 ms in duration.